

CIRCUIT CONNECTOR RIGHT ANGLE

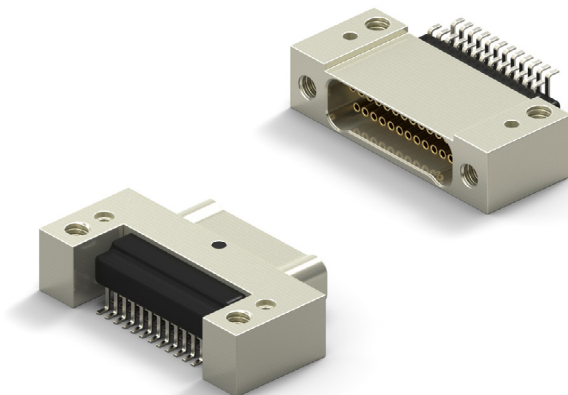









- Metal Shell Connector
- Surface Mount .025 x .040 (Style 28)
- 1 Piece Contact
- Flat Tail Termination
- Operating Temperature -50° C to 200° C
- 9 to 65 Contacts



NANO D – PID 135

HOW TO ORDER

* Indicates preferred standard ** Consult factory for other plating options

CN	M	28	L	25 - 2	P	Ø7	1	- SØ1			
Series	Style	Insulator	Contacts	Insulator Type	Contact Gender	Hardware	Lead Finish	Finish**	Temp Range	Mounting Option	
CN=Nano	M= Metal Shell	Style=28	L=LCP	Ø9	2= Dual Row	P= Male/Pin (Plug Side)	Ø7=Threaded Hole	1= Tin plated (6Ø/4Ø)	Blank= Cadmium	*Blank = 125C	*Blank=Threaded Mounting Holes
				15				2= Gold plated (RoHS)		HT = 200°C Supplied with Gold Plated Leads	
				21		S=Female/Socket (Receptacle Side)		*SØ1= Nickel			1=Solder Alignment Posts with Threaded Mounting Holes
				25							2=Clearance Mounting Holes
				31				SØ3 = Black Anodize			3=Solder Alignment Posts with Clearance Mounting Holes
				37							
				51				SØ9= Stainless			
				65							

DIMENSIONS

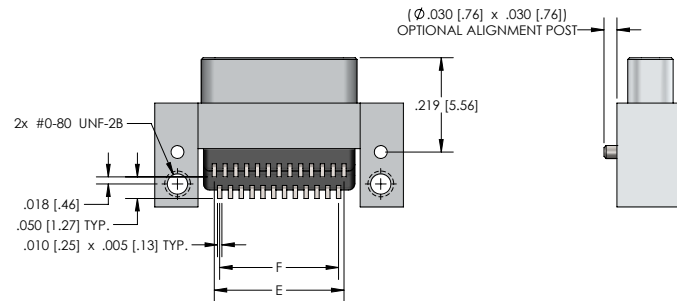
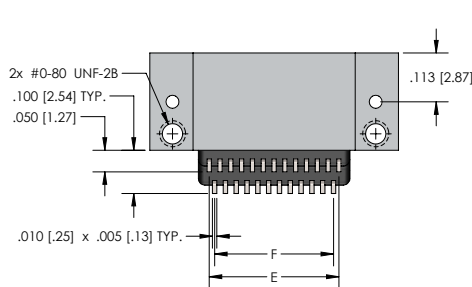
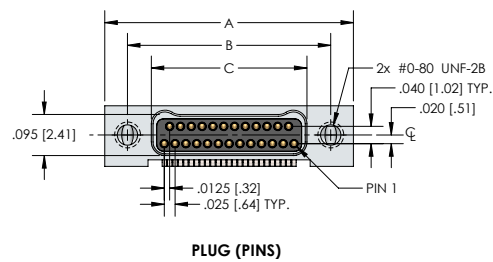
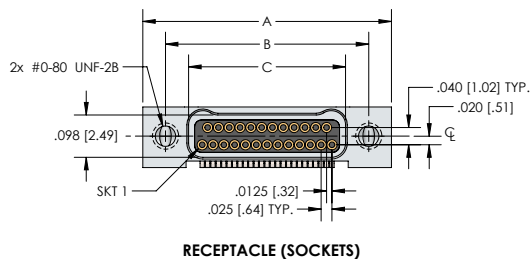
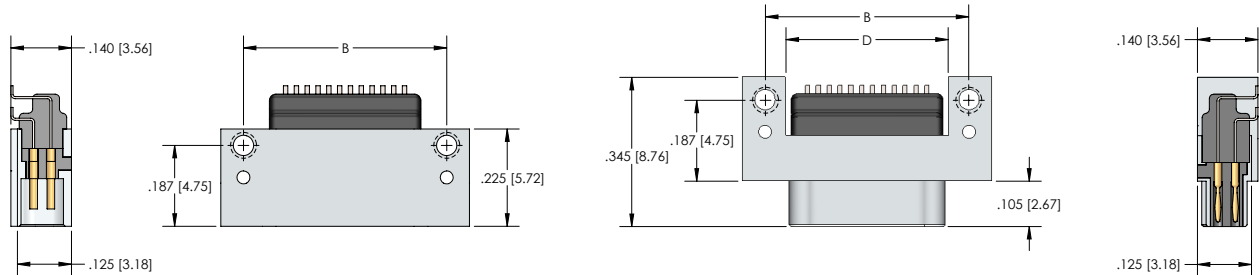

CNM28 SERIES (DUAL ROW)								
Size	A	B	Plug	C	Receptacle	D	E	F
9	.375 [9.52]	.270 [6.86]	.160 [4.06]		.163 [4.14]	.175 [4.44]	.100 [2.54]	.075 [1.90]
15	.450 [11.43]	.345 [8.76]	.235 [5.97]		.238 [6.04]	.250 [6.35]	.175 [4.44]	.150 [3.81]
21	.525 [13.33]	.420 [10.67]	.310 [7.87]		.313 [7.95]	.325 [8.25]	.250 [6.35]	.225 [5.71]
25	.575 [14.60]	.470 [11.94]	.360 [9.14]		.363 [9.22]	.375 [9.52]	.300 [7.62]	.275 [6.98]
31	.650 [16.51]	.545 [13.84]	.435 [11.05]		.438 [11.12]	.450 [11.43]	.375 [9.52]	.350 [8.89]
37	.725 [18.41]	.620 [15.75]	.510 [12.95]		.513 [13.03]	.525 [13.33]	.450 [11.43]	.425 [10.79]
51	.900 [22.86]	.795 [20.19]	.685 [17.40]		.688 [17.47]	.700 [17.78]	.625 [15.87]	.600 [15.24]
65	1.075 [27.30]	.970 [24.64]	.860 [21.84]		.863 [21.92]	.875 [22.22]	.800 [20.32]	.775 [19.68]

CIRCUIT CONNECTOR RIGHT ANGLE PCB LAYOUT MALE

NANO D – PID 135

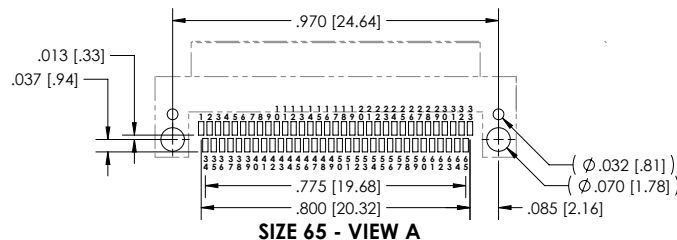
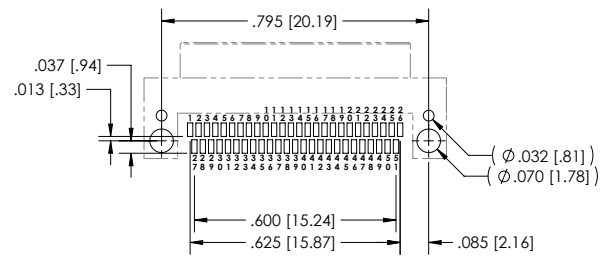
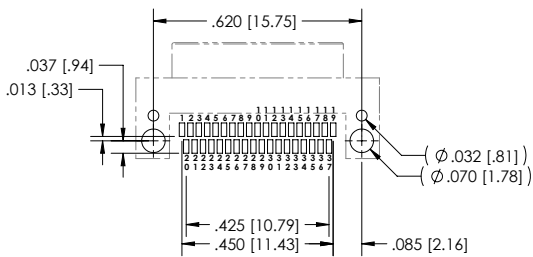
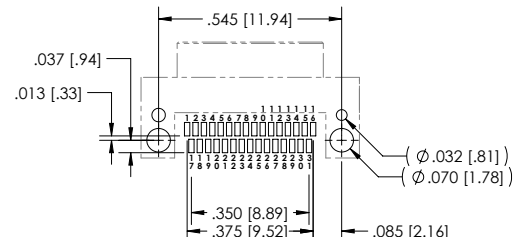
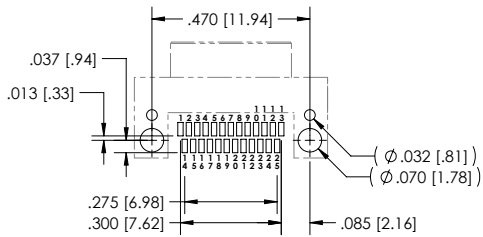
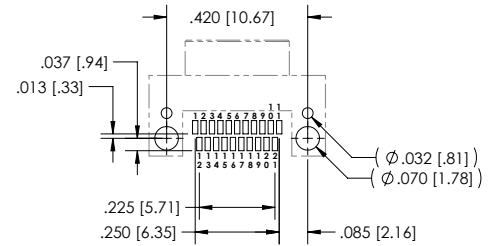
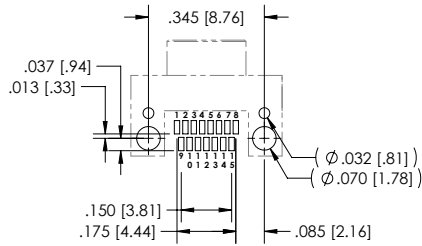
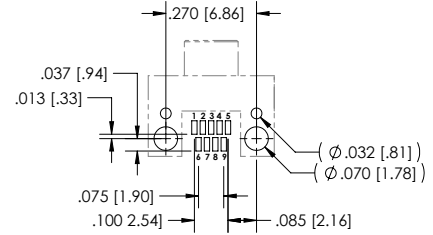
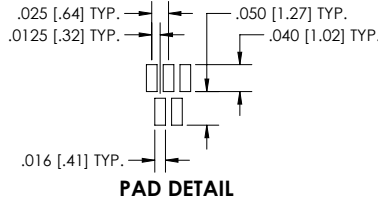
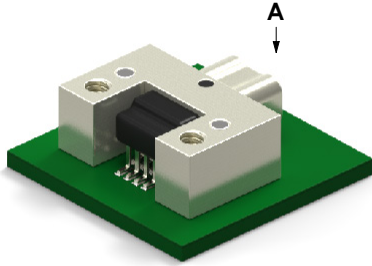

CIRCUIT CONNECTOR RIGHT ANGLE PCB LAYOUT FEMALE

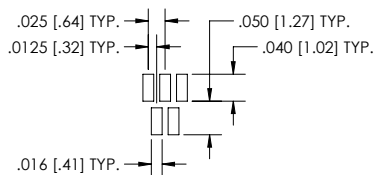
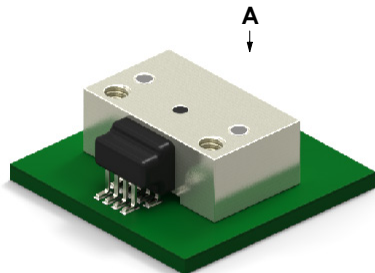

PAD DETAIL

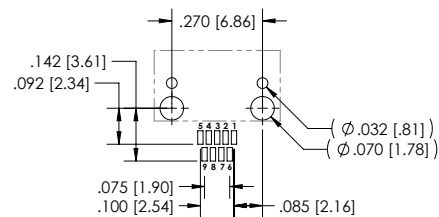

SIZE 9 - VIEW A

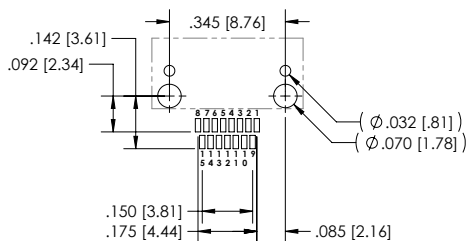

SIZE 15 - VIEW A

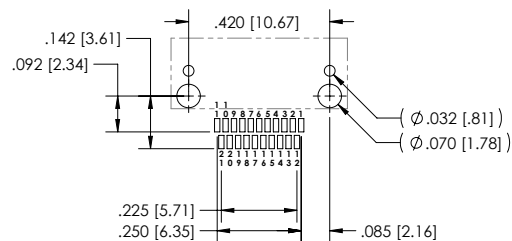

SIZE 21 - VIEW A

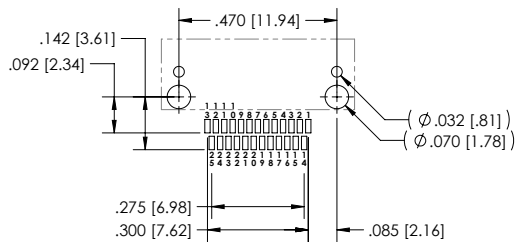

SIZE 25 - VIEW A

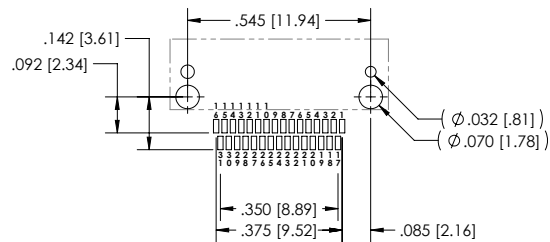

SIZE 31 - VIEW A

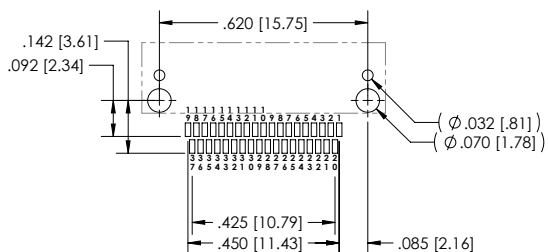

SIZE 37 - VIEW A

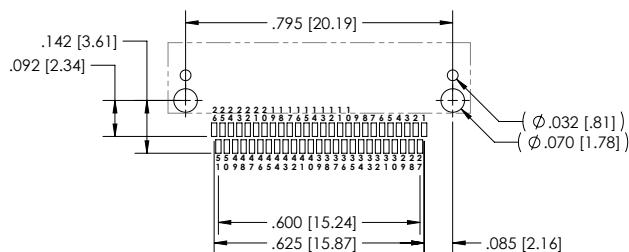

SIZE 51 - VIEW A

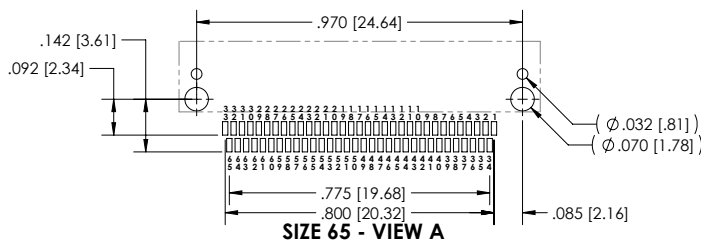

SIZE 65 - VIEW A

NANO-D CIRCUIT RIGHT ANGLE CONNECTOR METAL PERFORMANCE DATA, MATERIALS AND FINISHES

PERFORMANCE DATA

133-E	ELECTRICAL
CONTACT RESISTANCE:	0.033 mΩ max.@ 1.0 A
CURRENT RATING (SIGNAL CONTACTS):	1.0 A max.
DIELECTRIC WITHSTANDING VOLTAGE:	250 VAC at sea level , 100 VAC at 70,000 ft.
INSULATION RESISTANCE:	5,000 MΩ min.

123-M	MECHANICAL
CONTACT ENGAGING FORCE:	5 oz max. (Contact average is 2 oz.)
CONTACT SEPARATING FORCE:	0.4 oz. min.
CONNECTOR MATING FORCE:	7 oz. x number of contacts max.
CONNECTOR UNMATING FORCE:	7 oz. x number of contacts max.
VIBRATION:	No damage or interruption detected (one microsecond sensitivity) EIA-364-28 Condition IV
SHOCK:	No damage or interruption detected (one microsecond sensitivity) EIA-364-28 Condition IV
DURABILITY:	No mechanical or electrical defects after 200 matings.
SALT SPRAY:	No exposure of base metal or loss of performance after 96 hours for both Nickel and Cadmium plating

MATERIALS AND FINISHES

131-M&F	MATERIALS AND FINISHES
Pin Contacts	Pins: BeCu alloy strip per ASTM-B-194
Socket Contacts	Sockets: BeCu per ASTM-B-194
Contact Plating	Gold plate per ASTM B488, or SAE AMS 2422
Metal Shells	Aluminum alloy per SAE-AMS-QQ-A-200/8, Type 6061-T6, with electroless nickel SAE AMS2404, class 3 or 4 Aluminum alloy per SAE-AMS-QQ-A-200/8, Type 6061-T6, with cadmium plating per SAE-AMS-QQ-P-416, Type II, class 1 Aluminum alloy per SAE-AMS-QQ-A-200/8, Type 6061-T6, with black anodize plating per MIL-A-8625, Type III, class 2 Stainless Steel per ASTM A582
Molded Insulator Into Metal Housing/ Lead Organizer	LCP (Liquid Crystal Polymer) GLCP-30F OR PPS PER MIL-M-24519 GST-40F
Alignment Post	Corrosion resistant steel per ASTM A 582/A582 or ASTM A 581/A581M, Passivated per SAE AMS-2700