

Ulti-Mate

Connector Inc.

MICRO/NANO MINIATURE
CONNECTORS & CABLE ASSEMBLIES



Ulti-Mate Connector Inc.

MICRO AND NANO MINIATURE INTERCONNECT SOLUTIONS

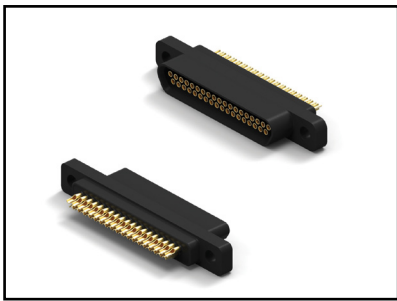

Ulti-Mate Connector, Inc. has been producing world-class Micro and Nano miniature connectors and interconnect solutions since 1978. Our expertise in the design and production of standard and customized solutions to the most demanding customer requirements has made Ulti-Mate a valued supplier to the OEM Marketplace. Providing the broadest range of Micro and Nano miniature connector and cable assembly products, our engineering team is ready to assist you from design through the production implementation of the most cost effective solution to your interconnect needs.

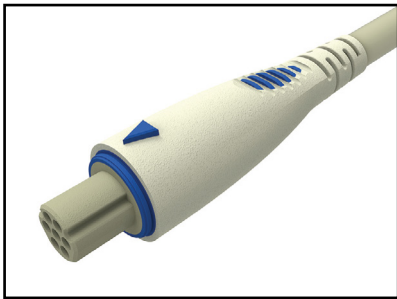

Ulti-Mate specializes in serving the unique interconnect solution needs of military, space, aviation, medical, and geophysical exploration marketplaces. Our reputation for cutting edge design, innovation and quality has placed Ulti-Mate Connectors in many of our country's most advanced avionics, missile systems, manned space and satellite vehicles, and guidance and navigation systems. Our ability to meet the demanding environmental requirements of the geophysical exploration industry has made Ulti-Mate a leading supplier to the largest and most advanced companies in the field. Ulti-Mate has a long history of meeting the rigorous specifications of invasive and noninvasive medical imaging, patient monitoring and the measured drug delivery markets.

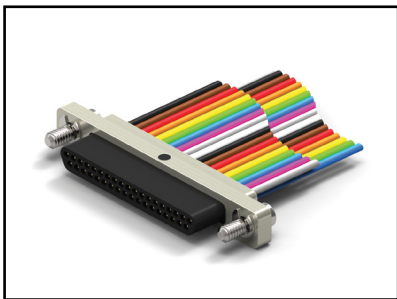

Located in Orange, California for over 35 years, Ulti-Mate prides itself on providing the highest levels of customer service and value with its "Made in America" interconnect solutions. Our experienced staff is dedicated to serving your interconnect needs with the latest design tools, state of the art test equipment and a customer support staff ready to assist you in all of your Micro and Nano miniature connector requirements.

TABLE OF CONTENTS	
ABOUT US	1
INTERCONNECT SOLUTIONS	4
MICRO-D TABLE OF CONTENTS	8
WIRED	
STANDARD PROFILE-METAL SHELL	10
STANDARD PROFILE-PLASTIC SHELL	12
LOW PROFILE-METAL SHELL	14
LOW PROFILE-PLASTIC SHELL	16
FIELD SOLDERABLE	
STANDARD PROFILE-METAL SHELL-SOLDERCUP	18
STANDARD PROFILE-PLASTIC SHELL	20
LOW PROFILE-METAL SHELL-SOLDERCUP	22
LOW PROFILE-PLASTIC SHELL-SOLDERCUP	24
NANO-D TABLE OF CONTENTS	26
WIRED	
SINGLE ROW-SINGLE ENDED-METAL SHELL	34
SINGLE ROW-DOUBLE ENDED-METAL SHELL	36
DUAL ROW-SINGLE ENDED-METAL SHELL	38
DUAL ROW-SINGLE ENDED-PLASTIC SHELL	40
DUAL ROW-DOUBLE ENDED-METAL SHELL	42
DUAL ROW-DOUBLE ENDED-PLASTIC SHELL	44
CIRCUIT	
RIGHT ANGLE	
SINGLE ROW-PLATED THRU HOLE-METAL SHELL	46
SINGLE ROW-SURFACE MOUNT-METAL SHELL	50
DUAL ROW-PLATED THRU HOLE-METAL SHELL	54
DUAL ROW-PLATED THRU HOLE-PLASTIC SHELL	58
DUAL ROW-SURFACE MOUNT-METAL SHELL	62
DUAL ROW-SURFACE MOUNT-PLASTIC SHELL	66
DUAL ROW-(EXTEND PROFILE-FEMALE ONLY) SURFACE MOUNT-METAL SHELL	70
DUAL ROW-(EXTEND PROFILE-FEMALE ONLY) SURFACE MOUNT-PLASTIC SHELL	74
VERTICAL	
SINGLE ROW-PLATED THRU HOLE-METAL SHELL	78
SINGLE ROW-SURFACE MOUNT-METAL SHELL	82
DUAL ROW-PLATED THRU HOLE-METAL SHELL	86
DUAL ROW-PLATED THRU HOLE-PLASTIC SHELL	90
DUAL ROW-SURFACE MOUNT-METAL SHELL	94
DUAL ROW-SURFACE MOUNT-PLASTIC SHELL	96
DUAL ROW-(LOW PROFILE-MALE ONLY) SURFACE MOUNT-METAL SHELL	102
DUAL ROW-(LOW PROFILE-MALE ONLY) SURFACE MOUNT-PLASTIC SHELL	106
LATCHING	
WIRED	
DUAL ROW-SINGLE ENDED-METAL SHELL	110
DUAL ROW-DOUBLE ENDED-METAL SHELL	112
CIRCUIT	
DUAL ROW-VERTICAL-PLATED THRU HOLE-METAL SHELL	114
DUAL ROW-VERTICAL-SURFACE MOUNT-METAL SHELL	118
DUAL ROW-RIGHT ANGLE-PLATED THRU HOLE-METAL SHELL	122
DUAL ROW-RIGHT ANGLE-SURFACE MOUNT-METAL SHELL	126
DUAL ROW-RIGHT ANGLE-SURFACE MOUNT-(EXTEND PROFILE,FEMALE ONLY)-METAL SHELL	130
FIELD ATTACHABLE	
DUAL ROW-METAL SHELL	134
DUAL ROW-PLASTIC SHELL	136
CIRCULAR INLINE-PLASTIC SHELL	138
CIRCULAR	
METAL BREAK AWAY WIRED-INLINE	140
PLASTIC WIRED-INLINE	142

INTERCONNECT SOLUTIONS

We offer one of the largest product offerings within the Micro and Nano Miniature interconnect market carefully designed to meet most every Micro and Nano miniature interconnect requirement.

Ulti-Mate Connector, Inc. is a privately-held company whose strengths include ISO 9001/2008 process approval, Mil-Spec approval to Mil-DTL-83513, full-spectrum product lines, fast

“turnaround” on quotes and custom orders, unsurpassed sales and technical support in every major market in the world.

Located in Orange California, our connectors, backshells and interconnect cable assemblies are all made in America. Many interconnect manufacturers are moving their production operations to Mexico, India, China and elsewhere, Ulti-Mate is proud to continue our long-standing tradition of making our products in quality controlled plants here in the USA.

WHY UMI?

- Superior customer service and focus.
- Extensive stock of raw components to facilitate short lead time and quick turn requirements.
- Wide-ranging expertise in cable assembly design and fabrication.
- We offer all standard Micro miniature connector configurations as well as custom arrangements with little or no tooling expense. We offer all standard Nano miniature connector configurations as well as custom arrangements with little or no tooling expense.
- Largest tooled product offering in the Microminiature/Nano miniature connector industry.
- RoHS COMPLIANT
Mil Qualified

ISO 9001/2008 Approval



COMPANY PROFILE

- Company established in 1978
- Located in Orange, California, USA
- Experienced management team with over 90 years in the Microminiature connector industry
- We possess the broadest range of Microminiature/Nanominiature connector products in the industry.
- Markets served are the military, space, commercial airframe, medical, geophysical exploration, telecom, and industrial markets.

HISTORY

Ulti-Mate Connector Inc. was founded in 1977 by Lou Schmid. Lou and his team had created the first Micro miniature connector product offering at ITT Cannon in 1962. Lou went on to establish this series as a standard offering at several other companies before opening his own company. At Ulti-Mate, Lou proved to be a restless innovator who pushed cutting edge technical solutions, created innovative tooling and spearheaded improvements that have resulted in the creation of standards still in use today.

HIGHLIGHTS

- 1978 Ulti-Mate Inc. was established in Orange, CA
- 1978 Ulti-Mate introduced the Mite-Y-Pin precision formed pin contact.
- 1979 Ulti-Mate Inc established molded in insulators as a standard for creating tighter dimensional tolerance within the shell.
- 1982 Ulti-Mate Inc created the only re-configurable mold tooling allowing Microminiature connectors from 5 to 65 contacts, in odd positions.
- 1983 Ulti-Mate Inc introduces high profile all plastic shells that mate with the standard Metal shell Micro miniature series and Metal shell connectors that mate with the standard low profile plastic shell series.

- 1984 Ulti-Mate Inc tools the first nano precision stamped pin contact and introduces their nano product line.
- 1988 M series and P series products were qualified to MIL-C-83513.
- 1989 Ulti-Mate was acquired by Molex Inc. and was assimilated into the New Ventures and Acquisitions group.
- 1991 Molex Industrial Interfaces and Ulti-Mate were co-located into a new facility in Orange, CA
- 1992 Molex Ulti-Mate established a manufacturing entity in the United Kingdom.
- 1994 A new In Flight Entertainment group was established within Ulti-Mate to address the burgeoning Airframe entertainment systems cable assembly market.
- 1999 Molex Ulti-Mate becomes certified to ISO 9001.
- 2001 Molex re-locates Ulti-Mate to Puerto Rico to lower assembly costs.
- 2003 Ulti-Mate is purchased from Molex Inc. by a management group consisting of current and previous employees. Ulti-Mate Connector Inc. is incorporated in Orange, California.
- 2009 Ulti-Mate Connector Inc. re-introduces an expanded nano miniature product

line including the only single piece contact system for printed circuit board connectors in the industry.

- 2009 Ulti-Mate Connector Inc. moves into a new facility effectively doubling our manufacturing floor.
- 2010 Ulti-Mate Connector Inc. becomes re-certified to ISO 9001.
- 2010 Using Six Sigma principles, Ulti-Mate Connector Inc. creates lean production cells for multiple products.
- 2010 Ulti-Mate Connector Inc. acquires the Molex CIC, formally Industrial Interface, product line of Industrial circular connector solutions.
- 2011 Ulti-Mate Connector Inc. re-qualifies to Mil-DTL-83513
- 2013 Ulti-Mate passes ISO 9001:2008 re-certification audit.

Ulti-Mate is proud to continue our long-standing tradition of making our products in quality controlled plants here in the USA.

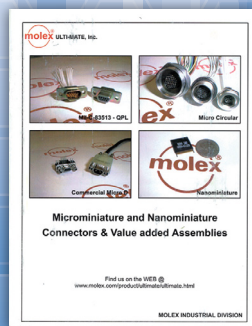
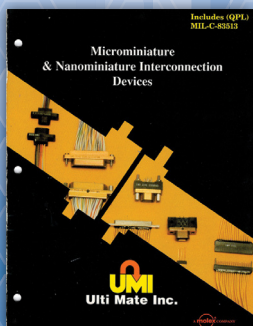

Our ability to meet the demanding environmental requirements of the geophysical exploration industry has made Ulti-Mate a leading supplier to the largest and most advanced companies in the field.

TECHNOLOGIES

- First Micro-D was introduced in the early 1960's.
- Originally designed to replace D-sub connectors in Military Missile applications.
- The design incorporated the size 24 contact in a reverse gender layout.
- Contact spacing of .050" yields 4 times the density of the D-sub.

MICRO/NANO CONTACTS

- **Pin** - Precision formed size 24 contact assures dimensional repeatability, superior plating coverage, higher columnar strength, and a cost advantage over the previous twisted pin designs.
- **Socket** - Drawn size 24 and 30 closed tube design assures the highest levels of performance during shock and Vibration.

MARKET FACTS

- The leading end use market for micro/nano connectors is the military/aerospace market.
- The second leading market is commercial aviation which includes guidance and navigation, avionics, and cargo loading.
- Computer and peripherals, medical equipment, instrumentation and industrial, "niche" opportunities account for the balance of the market.
- Reduced size and reliable performance in difficult environments drive the use of micro/nano connectors.

WHAT YOU SHOULD KNOW

- MOST STANDARD OPTIONS
Series M&P for metal, B for plastic
Wire length: 18", 36" AND 72"
Nickel plated shell
Wire type "E", "26 AWG"
Circuit style 6, 8 or 1





P/N SMART REFERENCE

- **Using a smart part number ordering**

MR (Metal shell for wire or solder cup connector)
BR (Plastic shell for wire or solder cup connector)
APR (Low profile metal shell plug)
AR (Low profile metal shell receptacle)
PR (Low profile plastic shell)
CM (Circuit series with metal shell)
CB (Circuit series with plastic shell)
SR (Strip series)

Any part number starting with M83513/XXXXXX

- **Customers can also order by their own part number**



MICRO-D SERIES

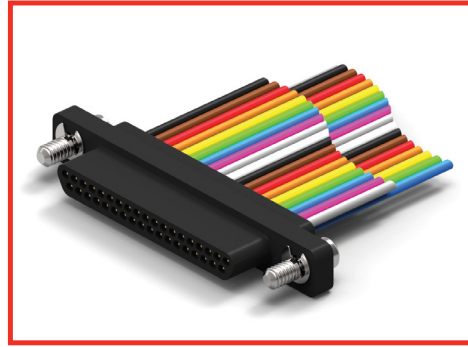
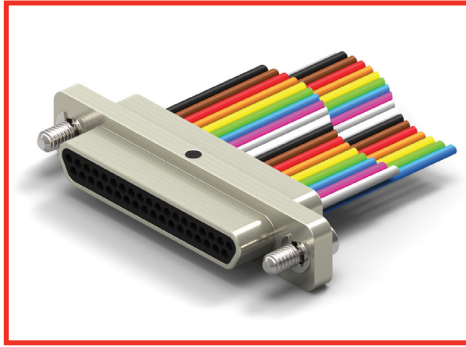

WIRED

STANDARD PROFILE-METAL SHELL.....	10
STANDARD PROFILE-PLASTIC SHELL.....	12
LOW PROFILE-METAL SHELL.....	14
LOW PROFILE-PLASTIC SHELL.....	16

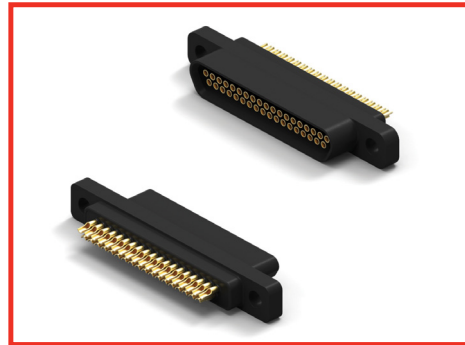
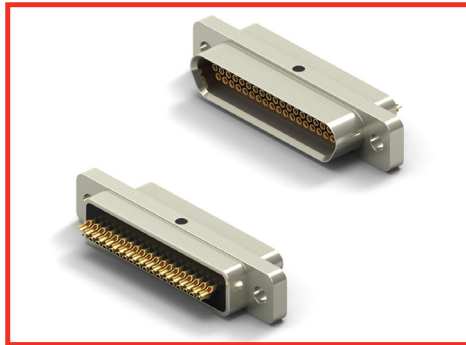

SOLDERABLE

STANDARD PROFILE-METAL SHELL-SOLDERCUP.....	18
STANDARD PROFILE-PLASTIC SHELL-SOLDERCUP.....	20
LOW PROFILE-METAL SHELL-SOLDERCUP.....	22
LOW PROFILE-PLASTIC SHELL-SOLDERCUP.....	24

PERFORMANCE DATA / MATERIALS AND FINISHES

10-E	ELECTRICAL
CONTACT RESISTANCE:	8 mΩ max.@ 2.5 A
CURRENT RATING (SIGNAL CONTACTS):	3 A max.
DIELECTRIC WITHSTANDING VOLTAGE:	900 VAC at sea level, 300 VAC at 70,000 ft.
INSULATION RESISTANCE:	5,000 MΩ min.

18-E	ELECTRICAL
CONTACT RESISTANCE:	8 mΩ max.@ 2.5 A
CURRENT RATING (SIGNAL CONTACTS):	3 A max.
DIELECTRIC WITHSTANDING VOLTAGE:	600 VAC at sea level, 150 VAC at 70,000 ft.
INSULATION RESISTANCE:	5,000 MΩ min.

10-M	MECHANICAL
CONTACT ENGAGING FORCE:	6 oz max. (Contact average is 3 oz.)
CONTACT SEPARATING FORCE:	0.5 oz. min.
CONNECTOR MATING FORCE:	10 oz. x number of contacts max.
CONNECTOR UNMATING FORCE:	10 oz. x number of contacts min.
VIBRATION:	No damage or interruption detected (one microsecond sensitivity) EIA-364-28 Condition IV
SHOCK:	No damage or interruption detected (one microsecond sensitivity) EIA-364-27 Condition E
DURABILITY:	No mechanical or electrical defects after 500 matings.
SALT SPRAY:	No exposure of base metal or loss of performance after 96 hours for both Nickel and Cadmium plating

10-M&F	MATERIALS AND FINISHES
Pin Contacts	Beryllium Copper (C17200) per ASTM B194.
Socket Contacts	Copper alloy (C21000) per ASTM B36
Contact Plating	Gold plated per ASTM-B488. 50 microinches min. is the standard thickness.
Metal Shells	Aluminum alloy per SAE-AMS-QQ-A-200/8, type 6061-T6. Finish is cadmium per SAE-AMS-QQ-P-416,TYPE II, CLASS 3, with suitable underplate with yellow chromate, this plating is not RoHS compliant. Or Finish Electroless Nickel plate per SAE AMS2404, class 3 or 4, .0005 minimum thickness.
Insulator Material Shell	Polyphenylene sulfide (PPS) per MIL-M-24519 GST 40F or ASTM D5927. Color Black.
Interfacial Seals	Fluorosilicone elastomer per MIL-R-25988. Standard on "M" Series socket face.
Hardware	Corrosion resistant steel per ASTM A 582/A582 or ASTM A 581/A581M, Passivated per SAE AMS-2700

18-M&F	MATERIALS AND FINISHES
Pin Contacts	Beryllium Copper (C17200) per ASTM B194.
Socket Contacts	Leaded commercial bronze (C314000) per ASTM B140.
Contact Plating	Gold plated per ASTM-B488. 50 microinches min. is the standard thickness.
Metal Shells	Aluminum alloy per SAE-AMS-QQ-A-200/8, type 6061-T6. Finish is cadmium per SAE-AMS-QQ-P-416,TYPE II, CLASS 3, with suitable underplate with yellow chromate, this plating is not RoHS compliant. Or Finish Electroless Nickel plate per SAE AMS2404, class 3 or 4, .0005 minimum thickness.
Insulator Material Shell	Fluorosilicone elastomer per MIL-R-25988. Standard on "M" Series socket face.
Interfacial Seals	Polyphenylene sulfide (PPS) per MIL-M-24519 GST 40F or ASTM D5927. Color Black.
Hardware	Corrosion resistant steel per ASTM A 582/A582 or ASTM A 581/A581M, Passivated per SAE AMS-2700









WIRED CONNECTOR

- Standard Profile Metal Shell Connector w/Wire Leads
- Environmentally Sealed
- Operating Temperature -50° C to 200° C
- 9 to 100 Contacts



HOW TO ORDER

* Indicates preferred standard ** Consult factory for other plating options *** Leave blank if no hardware required.

M	R	51-3	P	Ø2 -	26	E	6 -	18.0 -	SØ1	
Series	Insulator	Contacts	Contact Gender	Hardware***	Wire Gauge	Wire Type	Color Code	Length	Finish**	Temp Range
M= Metal	R=PPS	Ø9	P=Male/Pin (Plug Side)	*Ø2 (12 for Size 1ØØ) 22 (Swaged)	24	C =Solid Wire, Uninsulated	1 = White	*18.0	Blank= Cadmium	*Blank =125C
		15			25	*E =Stranded w/Teflon Insulation, per NEMA HP3-EX	2 = Yellow	*36.0		HT = 2ØØC
		21	S=Female/Socket (Receptacle Side)	Ø3 (13 for Size 1ØØ)	26*	F =Stranded, w/Teflon Insulation, per NEMA HP3-ET	3 = Tin plated (Solid Wire)		*SØ1 = Nickel	
		25			28	M =Stranded, w/Teflon Insulation, per SAE-AS22759/11	4 = Gold plated (Solid Wire)			
		31		*Ø5 (15 for Size 1ØØ)	3Ø	Y = Stranded w/ Tefzel Insulation, per SAE-AS22759/33	5 = Color Code per MIL-STD-681 (Non-Repeating Colors)		SØ3 = Black Anodize	
		37					*6 =1Ø Solid Colors, Repeating			
				Ø6 (16 for Size 1ØØ)					SØ6 =Olive-Drab Cadmium	
		51-3								
				Ø7 (17 for Size 1ØØ)					SØ7 =Titanium	
		1ØØ								
									SØ9 =Stainless	
										

ELECTRICAL PERFORMANCE DATA

Go to Page 9 See chart 10 E or Click Here for Electrical Performance Data

MECHANICAL PERFORMANCE DATA

Go to Page 9 See chart 10 M or Click Here for Mechanical Performance Data

MATERIALS AND FINISHES DATA

Go to Page 9 See chart 10 M&F or Click Here for Materials and Finishes Data

DIMENSIONS

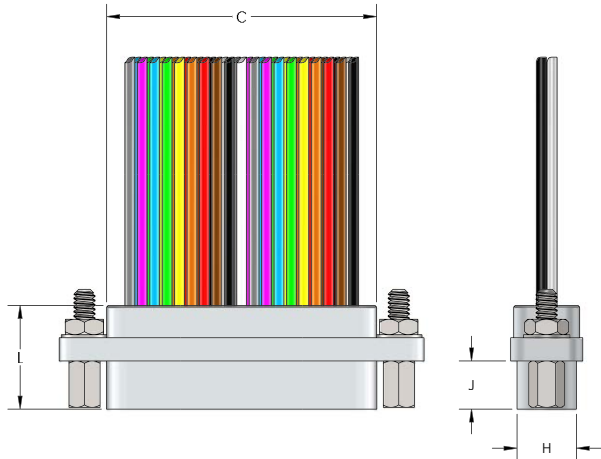

RECEPTACLE (SOCKETS)

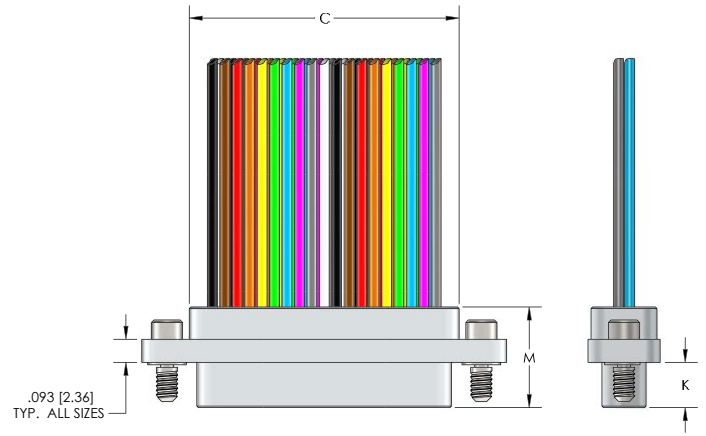

PLUG (PINS)

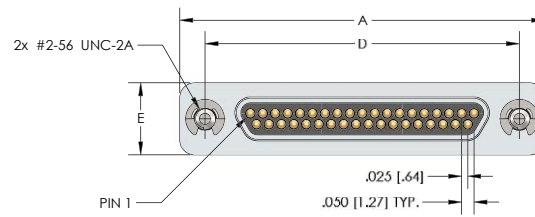
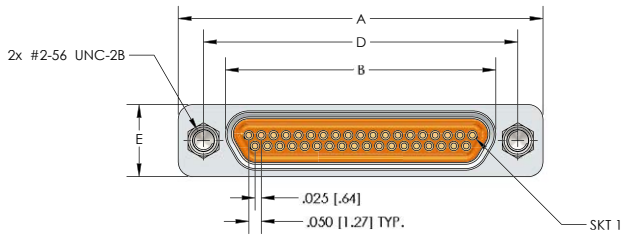

Size	ALL	M SERIES								
	A Max.	B Max.	C Max.	D Max.	H Max.	E Max.	J Max. (Skt)	K Max. (Pin)	L Max. (Skt)	M Max. (Pin)
9	.785 (19.94)	.402 (10.21)	.393 (9.98)	.565 (14.35)	.248 (6.30)	.308 (7.83)	.199 (5.05)	.187 (4.75)	.429 (10.90)	.416 (10.57)
15	.935 (23.75)	.552 (14.02)	.543 (13.79)	.715 (18.16)	.248 (6.30)	.308 (7.83)	.199 (5.05)	.187 (4.75)	.429 (10.90)	.416 (10.57)
21	1.085 (27.56)	.702 (17.83)	.693 (17.60)	.865 (21.47)	.248 (6.30)	.308 (7.83)	.199 (5.05)	.187 (4.75)	.429 (10.90)	.416 (10.57)
25	1.185 (30.10)	.802 (20.37)	.793 (20.14)	.965 (24.51)	.248 (6.30)	.308 (7.83)	.199 (5.05)	.187 (4.75)	.429 (10.90)	.416 (10.57)
31	1.335 (33.91)	.952 (24.18)	.943 (23.95)	1.115 (28.32)	.248 (6.30)	.308 (7.83)	.199 (5.05)	.187 (4.75)	.429 (10.90)	.416 (10.57)
37	1.485 (37.72)	1.102 (27.99)	1.093 (27.76)	1.265 (32.13)	.248 (6.30)	.308 (7.83)	.199 (5.05)	.187 (4.75)	.429 (10.90)	.416 (10.57)
51	1.435 (36.45)	1.054 (26.77)	1.041 (26.44)	1.215 (30.86)	.297 (7.54)	.351 (8.92)	.199 (5.05)	.187 (4.75)	.429 (10.90)	.416 (10.57)
100	2.165 (54.99)	1.505 (38.23)	1.442 (36.63)	1.800 (45.72)	.394 (10.00)	.394 (10.00)	.199 (5.05)	.187 (4.75)	.429 (10.90)	.416 (10.57)











WIRED CONNECTOR

- Standard Profile Plastic Shell Connector w/Wire Leads
- Environmentally Sealed
- Operating Temperature -50° C to 200° C
- 9 to 100 Contacts



HOW TO ORDER

* Indicates preferred standard *** Leave blank if no hardware required.

B	R	51-3	P	Ø -	26	E	6 -	18.0	
Series	Insulator	Contacts	Contact Gender	Hardware***	Wire Gauge	Wire Type	Color Code	Length	Temp Range
B=Plastic Shell	R=PPS	09	P=Male/Pin (Plug Side)	*Ø2 (12 for Size 100) 22 (Swaged)	24	C = Solid Wire, Uninsulated	1 = White	*18.0	*Blank =125C
		15			25	*E = Stranded w/Teflon Insulation, per NEMA HP3-EX	2 = Yellow	*36.0	HT = 200C
		21	S=Female/Socket (Receptacle Side)	Ø3 (13 for Size 100)	26*	F = Stranded, w/Teflon Insulation, per NEMA HP3-ET	3 = Tin plated (Solid Wire)		
		25			28	M = Stranded, w/Teflon Insulation, per SAE-AS22759/11	4 = Gold plated (Solid Wire)		
		31		*Ø5 (15 for Size 100)	30	Y = Stranded w/Tefzel Insulation, per SAE-AS22759/33	5 = Color Code per MIL-STD-681 (Non-Repeating Colors)		
		37					*6 = 10 Solid Colors, Repeating		
				Ø6 (16 for Size 100)					
		51-3							
				Ø7 (17 for Size 100)					
		100							
									

ELECTRICAL PERFORMANCE DATA

Go to Page 9 See chart 10 E or Click Here for Electrical Performance Data

MECHANICAL PERFORMANCE DATA

Go to Page 9 See chart 10 M or Click Here for Mechanical Performance Data

MATERIALS AND FINISHES DATA

Go to Page 9 See chart 10 M&F or Click Here for Materials and Finishes Data

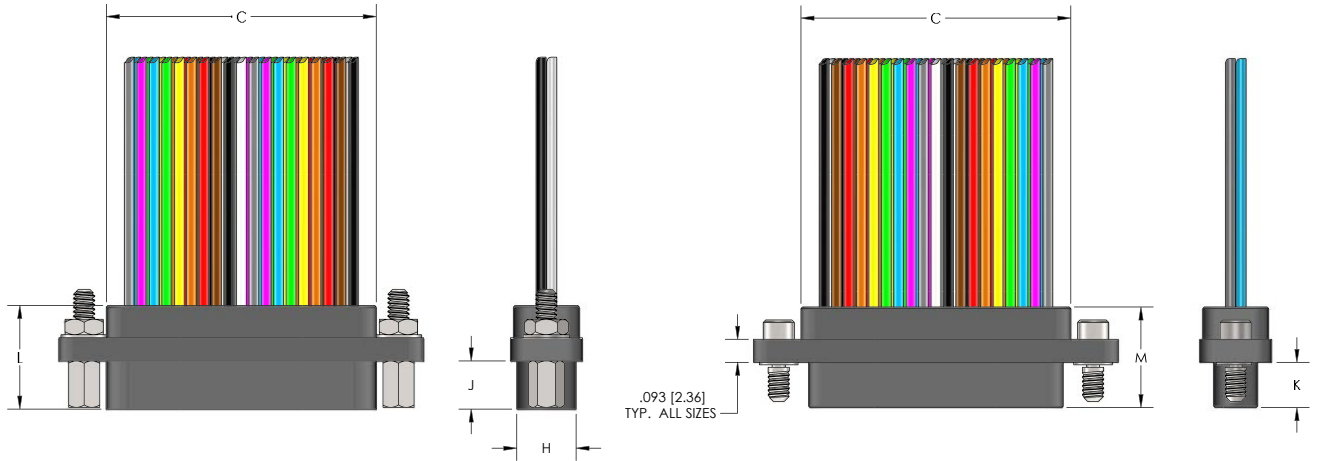

RECEPTACLE (SOCKETS)

PLUG (PINS)

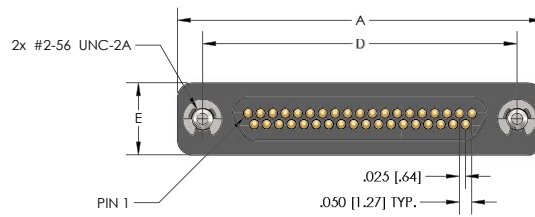
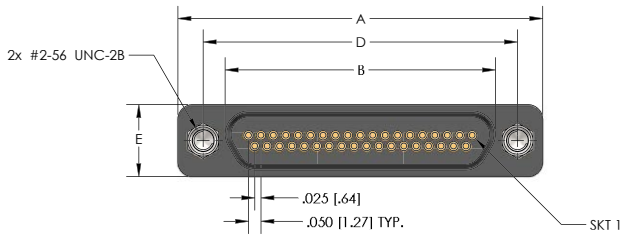

Size	ALL		M SERIES							
	A Max.	B Max.	C Max.	D Max.	H Max.	E Max.	J Max. (Skt)	K Max. (Pin)	L Max. (Skt)	M Max. (Pin)
9	.785 (19.94)	.402 (10.21)	.393 (9.98)	.565 (14.35)	.248 (6.30)	.308 (7.83)	.199 (5.05)	.187 (4.75)	.429 (10.90)	.416 (10.57)
15	.935 (23.75)	.552 (14.02)	.543 (13.79)	.715 (18.16)	.248 (6.30)	.308 (7.83)	.199 (5.05)	.187 (4.75)	.429 (10.90)	.416 (10.57)
21	1.085 (27.56)	.702 (17.83)	.693 (17.60)	.865 (21.47)	.248 (6.30)	.308 (7.83)	.199 (5.05)	.187 (4.75)	.429 (10.90)	.416 (10.57)
25	1.185 (30.10)	.802 (20.37)	.793 (20.14)	.965 (24.51)	.248 (6.30)	.308 (7.83)	.199 (5.05)	.187 (4.75)	.429 (10.90)	.416 (10.57)
31	1.335 (33.91)	.952 (24.18)	.943 (23.95)	1.115 (28.32)	.248 (6.30)	.308 (7.83)	.199 (5.05)	.187 (4.75)	.429 (10.90)	.416 (10.57)
37	1.485 (37.72)	1.102 (27.99)	1.093 (27.76)	1.265 (32.13)	.248 (6.30)	.308 (7.83)	.199 (5.05)	.187 (4.75)	.429 (10.90)	.416 (10.57)
51	1.435 (36.45)	1.054 (26.77)	1.041 (26.44)	1.215 (30.86)	.297 (7.54)	.351 (8.92)	.199 (5.05)	.187 (4.75)	.429 (10.90)	.416 (10.57)
100	2.165 (54.99)	1.505 (38.23)	1.442 (36.63)	1.800 (45.72)	.394 (10.00)	.394 (10.00)	.199 (5.05)	.187 (4.75)	.429 (10.90)	.416 (10.57)















WIRED CONNECTOR

- Standard Profile Metal Shell Connector w/Wire Leads
- Environmentally Sealed
- Operating Temperature -50° C to 200° C
- 9 to 51 Contacts



HOW TO ORDER

* Indicates preferred standard ** Consult factory for other plating options *** Leave blank if no hardware required.

Series	Insulator	Contacts	Contact Gender	Hardware***	Wire Gauge	Wire Type	Color Code	Length	Finish**	Temp Range	
A = Metal Shell (Receptacle)	R = PPS	9	P=Male/Pin (Plug Side)	*Ø2 (12 for Size 1ØØ) 22 (Swaged)	24	C =Solid Wire, Uninsulated	1 = White	*18.Ø	Blank= Cadmium	*Blank =125C	
		15			25	*E =Stranded w/Teflon Insulation, per NEMA HP3-EX	2 = Yellow	*36.Ø		HT = 2ØØC	
AP = Metal Shell w/Plastic shroud (Plug)		21	S=Female/Socket (Receptacle Side)	Ø3 (13 for Size 1ØØ)	26*	F =Stranded, w/Teflon Insulation, per NEMA HP3-ET	3 = Tin plated (Solid Wire)		*SØ1= Nickel		
		25			28	M =Stranded, w/Teflon Insulation, per SAE-AS22759/11	4 = Gold plated (Solid Wire)				
		31			*Ø5 (15 for Size 1ØØ)	3Ø	Y = Stranded w/ Tefzel Insulation, per SAE-AS22759/33	5 = Color Code per MIL-STD-681 (Non-Repeating Colors)		SØ3 = Black Anodize	
		37						*6 =1Ø Solid Colors, Repeating			
					Ø6 (16 for Size 1ØØ)					SØ6 =Olive-Drab Cadmium	
		51-3									
					Ø7 (17 for Size 1ØØ)					SØ7 =Titanium	
											SØ9 =Stainless

ELECTRICAL PERFORMANCE DATA	Go to Page 9 See chart 10 E or Click Here for Electrical Performance Data
MECHANICAL PERFORMANCE DATA	Go to Page 9 See chart 10 M or Click Here for Mechanical Performance Data
MATERIALS AND FINISHES DATA	Go to Page 9 See chart 10 M&F or Click Here for Materials and Finishes Data

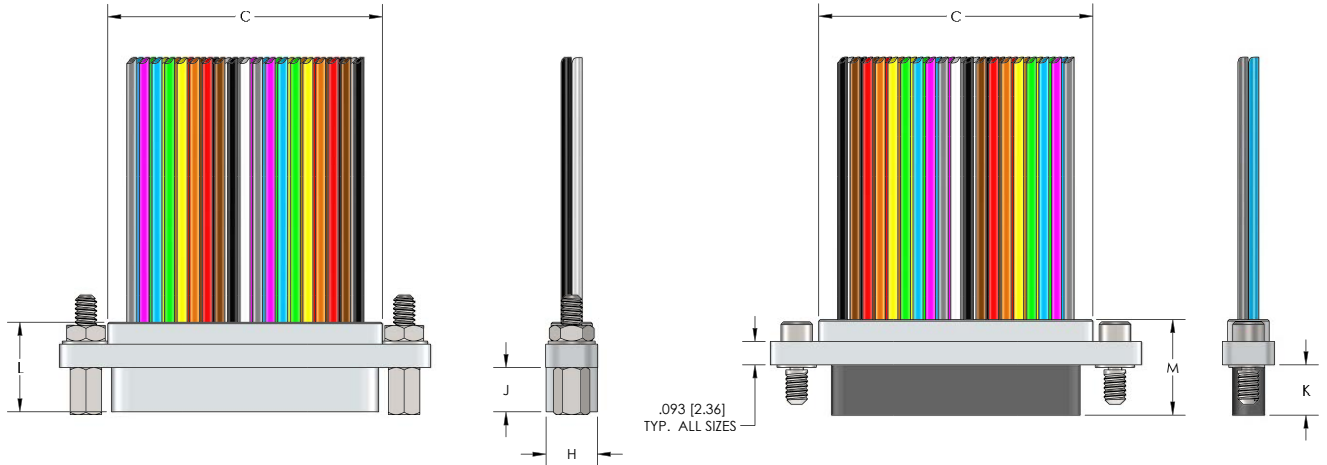

RECEPTACLE (SOCKETS)

PLUG (PINS)

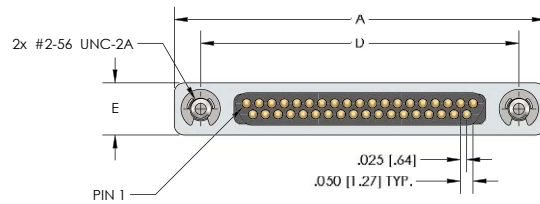
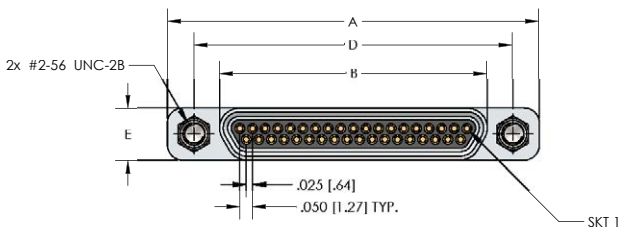

Size	ALL		A SERIES								
	A Max.	B Max.	C Max.	D Max.	H Max.	E Max.	G Max.	J Max. (Skt)	K Max. (Pin)	L Max. (Skt)	M Max. (Pin)
9	.785 (19.94)	.376 (9.55)	.393 (9.98)	.565 (14.35)	.218 (5.54)	.218 (5.54)	.174 (4.42)	.182 (4.62)	.209 (5.31)	.375 (9.57)	.395 (10.03)
15	.935 (23.75)	.526 (13.36)	.543 (13.79)	.715 (18.16)	.218 (5.54)	.218 (5.54)	.174 (4.42)	.182 (4.62)	.209 (5.31)	.375 (9.57)	.395 (10.03)
21	1.085 (27.56)	.693 (17.17)	.693 (17.60)	.865 (21.97)	.218 (5.54)	.218 (5.54)	.174 (4.42)	.182 (4.62)	.209 (5.31)	.375 (9.57)	.395 (10.03)
25	1.185 (30.10)	.776 (19.71)	.793 (20.14)	.965 (24.51)	.218 (5.54)	.218 (5.54)	.174 (4.42)	.182 (4.62)	.209 (5.31)	.375 (9.57)	.395 (10.03)
31	1.335 (33.91)	.926 (23.52)	.943 (23.95)	1.115 (28.32)	.218 (5.54)	.218 (5.54)	.174 (4.42)	.182 (4.62)	.209 (5.31)	.375 (9.57)	.395 (10.03)
37	1.485 (37.72)	1.076 (27.33)	1.093 (27.76)	1.265 (32.13)	.218 (5.54)	.218 (5.54)	.174 (4.42)	.182 (4.62)	.209 (5.31)	.375 (9.57)	.395 (10.03)
51-3	1.435 (36.45)	1.026 (26.06)	1.041 (26.44)	1.215 (30.86)	.254 (6.45)	.254 (6.45)	.223 (5.66)	.182 (4.62)	.209 (5.31)	.375 (9.57)	.395 (10.03)









WIRED CONNECTOR

- Low Profile Plastic Shell Connector w/Wire Leads
- Environmentally Sealed
- Operating Temperature -50° C to 200° C
- 9 to 51 Contacts



HOW TO ORDER

* Indicates preferred standard *** Leave blank if no hardware required.

Series	Insulator	Contacts	Contact Gender	Hardware***	Wire Gauge	Wire Type	Color Code	Length	Temp Range
B=Plastic Shell	R = PPS	9	P = Male / Pin (Plug Side)	*Ø2	24	C = Solid Wire, Uninsulated	1 = White	*18.Ø	*Blank =125C
		15			25	*E = Stranded w/Teflon Insulation, per NEMA HP3-EX	2 = Yellow	*36.Ø	HT = 2ØØC
		21	T = Female/Socket (Receptacle Side)	Ø3	26*	F = Stranded, w/Teflon Insulation, per NEMA HP3-ET	3 = Tin plated (Solid Wire)		
		25			28	M = Stranded, w/Teflon Insulation, per SAE-AS22759/11	4 = Gold plated (Solid Wire)		
		31		*Ø5	3Ø	Y = Stranded w/Tefzel Insulation, per SAE-AS22759/33	5 = Color Code per MIL-STD-681 (Non-Repeating Colors)		
		37					*6 = 1Ø Solid Colors, Repeating		
				Ø6					
		51-3							
				Ø7					
									

MECHANICAL PERFORMANCE DATA	Go to Page 9 See chart 10 M or Click Here for Mechanical Performance Data
ELECTRICAL PERFORMANCE DATA	Go to Page 9 See chart 10 E or Click Here for Electrical Performance Data
MATERIALS AND FINISHES DATA	Go to Page 9 See chart 10 M&F or Click Here for Materials and Finishes Data

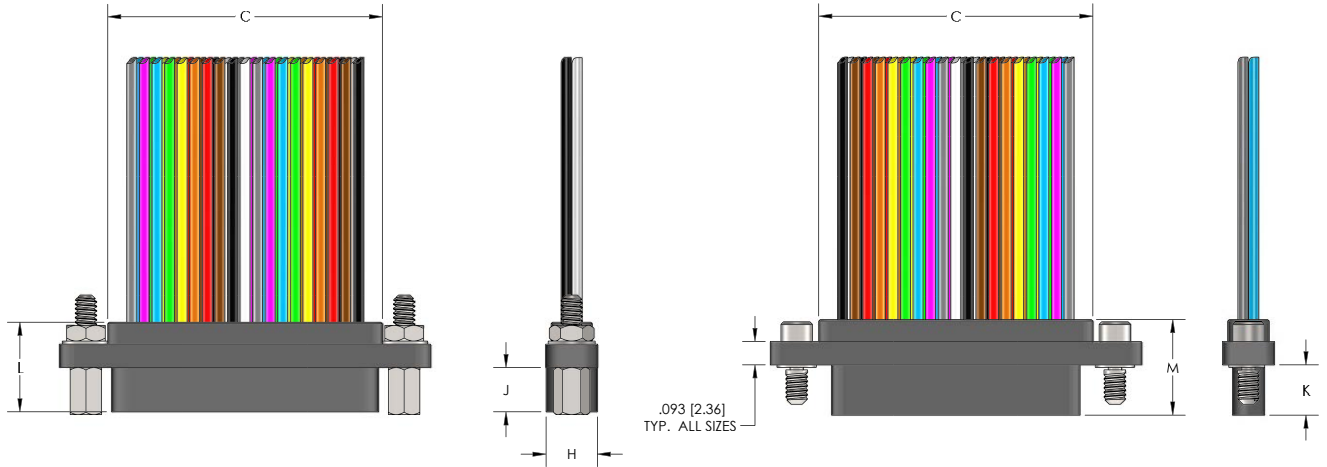

RECEPTACLE (SOCKETS)

PLUG (PINS)

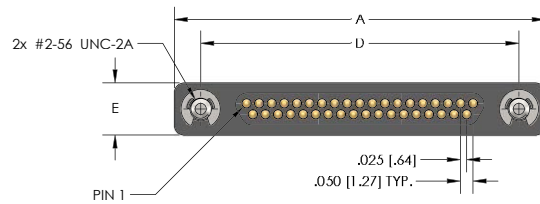
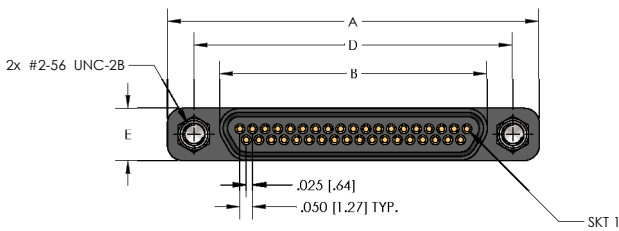

Size	ALL		P SERIES								
	A Max.	B Max.	C Max.	D Max.	H Max.	E Max.	G Max.	J Max. (Skt)	K Max. (Pin)	L Max. (Skt)	M Max. (Pin)
9	.785 (19.94)	.376 (9.55)	.393 (9.98)	.565 (14.35)	.218 (5.54)	.218 (5.54)	.174 (4.42)	.182 (4.62)	.209 (5.31)	.375 (9.57)	.395 (10.03)
15	.935 (23.75)	.526 (13.36)	.543 (13.79)	.715 (18.16)	.218 (5.54)	.218 (5.54)	.174 (4.42)	.182 (4.62)	.209 (5.31)	.375 (9.57)	.395 (10.03)
21	1.085 (27.56)	.693 (17.17)	.693 (17.60)	.865 (21.97)	.218 (5.54)	.218 (5.54)	.174 (4.42)	.182 (4.62)	.209 (5.31)	.375 (9.57)	.395 (10.03)
25	1.185 (30.10)	.776 (19.71)	.793 (20.14)	.965 (24.51)	.218 (5.54)	.218 (5.54)	.174 (4.42)	.182 (4.62)	.209 (5.31)	.375 (9.57)	.395 (10.03)
31	1.335 (33.91)	.926 (23.52)	.943 (23.95)	1.115 (28.32)	.218 (5.54)	.218 (5.54)	.174 (4.42)	.182 (4.62)	.209 (5.31)	.375 (9.57)	.395 (10.03)
37	1.485 (37.72)	1.076 (27.33)	1.093 (27.76)	1.265 (32.13)	.218 (5.54)	.218 (5.54)	.174 (4.42)	.182 (4.62)	.209 (5.31)	.375 (9.57)	.395 (10.03)
51-3	1.435 (36.45)	1.026 (26.06)	1.041 (26.44)	1.215 (30.86)	.254 (6.45)	.254 (6.45)	.223 (5.66)	.182 (4.62)	.209 (5.31)	.375 (9.57)	.395 (10.03)

















FIELD SOLDERABLE CONNECTOR

- Standard Profile Metal Shell Connector w/Solder Cup Contacts
- Environmentally Sealed
- Operating Temperature -50° C to 200° C
- 9 to 100 Contacts Accepting 24 AWG Wire



HOW TO ORDER

* Indicates preferred standard, ** Consult factory for other plating options *** Leave blank if no hardware required.

M	R	51-3	N	Ø	- SØ1	
Series	Insulator	Contacts	Contact Gender	Hardware***	Finish**	Temp Range
M=Metal	R=PPS	Ø9	N= Male / Pin (Plug Side)	*Ø2 (12 for Size 1ØØ) 22 (Swaged)	Blank= Cadmium	*Blank =125C
		15				HT = 2ØØC
		21	T = Female/Socket (Receptacle Side)	Ø3 (13 for Size 1ØØ)	*SØ1 = Nickel	
		25				
		31	TT = Female/Socket (Receptacle Side) for 24 AWG wire	*Ø5 (15 for Size 1ØØ)	SØ3 = Black Anodize	
		37				
				Ø6 (16 for Size 1ØØ)	SØ6 = Olive-Drab Cadmium	
		51-3				
				Ø7 (17 for Size 1ØØ)	SØ7 =Titanium	
		1ØØ				
					SØ9=Stainless	
						

ELECTRICAL PERFORMANCE DATA	Go to Page 9 See chart 18 E or Click Here for Electrical Performance Data
MECHANICAL PERFORMANCE DATA	Go to Page 9 See chart 18 M or Click Here for Mechanical Performance Data
MATERIALS AND FINISHES DATA	Go to Page 9 See chart 18 M&F or Click Here for Materials and Finishes Data

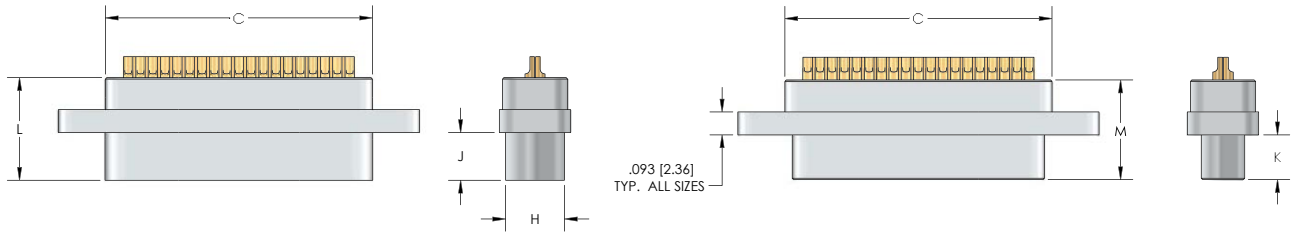

RECEPTACLE (SOCKETS)

PLUG (PINS)

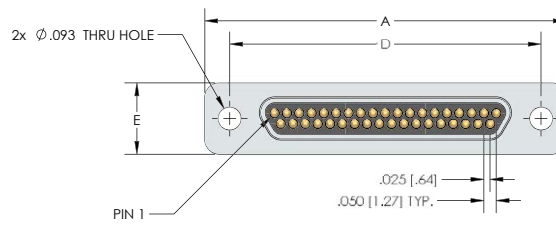
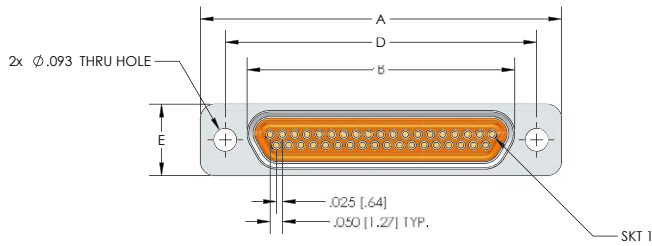

Size	ALL				M SERIES					
	A Max.	B Max.	C Max.	D Max.	H Max.	E Max.	J Max. (Skt)	K Max. (Pin)	L Max. (Skt)	M Max. (Pin)
9	.785 (19.94)	.402 (10.21)	.393 (9.98)	.565 (14.35)	.248 (6.30)	.308 (7.83)	.199 (5.05)	.187 (4.75)	.429 (10.90)	.416 (10.57)
15	.935 (23.75)	.552 (14.02)	.543 (13.79)	.715 (18.16)	.248 (6.30)	.308 (7.83)	.199 (5.05)	.187 (4.75)	.429 (10.90)	.416 (10.57)
21	1.085 (27.56)	.702 (17.83)	.693 (17.60)	.865 (21.47)	.248 (6.30)	.308 (7.83)	.199 (5.05)	.187 (4.75)	.429 (10.90)	.416 (10.57)
25	1.185 (30.10)	.802 (20.37)	.793 (20.14)	.965 (24.51)	.248 (6.30)	.308 (7.83)	.199 (5.05)	.187 (4.75)	.429 (10.90)	.416 (10.57)
31	1.335 (33.91)	.952 (24.18)	.943 (23.95)	1.115 (28.32)	.248 (6.30)	.308 (7.83)	.199 (5.05)	.187 (4.75)	.429 (10.90)	.416 (10.57)
37	1.485 (37.72)	1.102 (27.99)	1.093 (27.76)	1.265 (32.13)	.248 (6.30)	.308 (7.83)	.199 (5.05)	.187 (4.75)	.429 (10.90)	.416 (10.57)
51	1.435 (36.45)	1.054 (26.77)	1.041 (26.44)	1.215 (30.86)	.297 (7.54)	.351 (8.92)	.199 (5.05)	.187 (4.75)	.429 (10.90)	.416 (10.57)
100	2.165 (54.99)	1.505 (38.23)	1.442 (36.63)	1.800 (45.72)	.394 (10.00)	.394 (10.00)	.199 (5.05)	.187 (4.75)	.429 (10.90)	.416 (10.57)







FIELD SOLDERABLE CONNECTOR

- Standard Profile Plastic Shell Connector w/Solder Cup Contacts
- Environmentally Sealed
- Operating Temperature -50° C to 200° C
- 9 to 100 Contacts Accepting 24 AWG Wire



HOW TO ORDER

* Indicates preferred standard *** Leave blank if no hardware required.

B	R	51-3	N	Ø	
Series	Insulator	Contacts	Contact Gender	Hardware***	Temp Range
B = Plastic Shell	R=PPS	Ø9	N= Male / Pin (Plug Side)	*Ø2 (12 for Size 1ØØ) 22 (Swaged)	*Blank =125C
		15			HT = 2ØØC
		21	T = Female/Socket (Receptacle Side)	Ø3 (13 for Size 1ØØ)	
		25			
		31	TT = Female/Socket (Receptacle Side) for 24 AWG wire	*Ø5 (15 for Size 1ØØ)	
		37			
		51-3		Ø6 (16 for Size 1ØØ)	
		1ØØ			
				Ø7 (17 for Size 1ØØ)	
					

ELECTRICAL PERFORMANCE DATA

Go to Page 9 See chart 18 E or Click Here for Electrical Performance Data

MECHANICAL PERFORMANCE DATA

Go to Page 9 See chart 18 M or Click Here for Mechanical Performance Data

MATERIALS AND FINISHES DATA

Go to Page 9 See chart 18 M&F or Click Here for Materials and Finishes Data

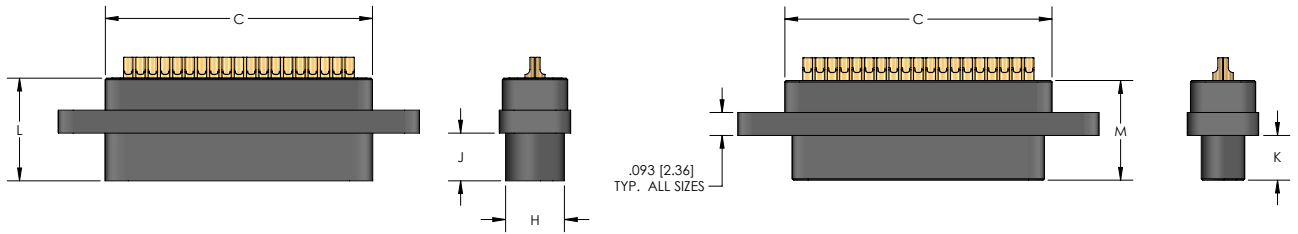

RECEPTACLE (SOCKETS)

PLUG (PINS)

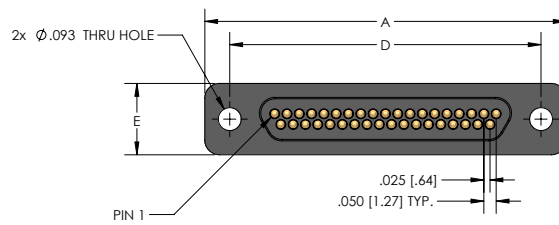
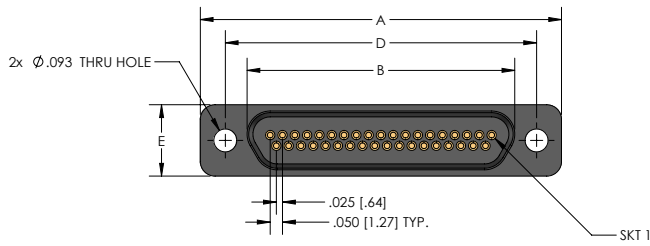

Size	ALL		B SERIES							
	A Max.	B Max.	C Max.	D Max.	H Max.	E Max.	J Max. (Skt)	K Max. (Pin)	L Max. (Skt)	M Max. (Pin)
9	.785 (19.94)	.402 (10.21)	.393 (9.98)	.565 (14.35)	.248 (6.30)	.308 (7.83)	.199 (5.05)	.187 (4.75)	.429 (10.90)	.416 (10.57)
15	.935 (23.75)	.552 (14.02)	.543 (13.79)	.715 (18.16)	.248 (6.30)	.308 (7.83)	.199 (5.05)	.187 (4.75)	.429 (10.90)	.416 (10.57)
21	1.085 (27.56)	.702 (17.83)	.693 (17.60)	.865 (21.47)	.248 (6.30)	.308 (7.83)	.199 (5.05)	.187 (4.75)	.429 (10.90)	.416 (10.57)
25	1.185 (30.10)	.802 (20.37)	.793 (20.14)	.965 (24.51)	.248 (6.30)	.308 (7.83)	.199 (5.05)	.187 (4.75)	.429 (10.90)	.416 (10.57)
31	1.335 (33.91)	.952 (24.18)	.943 (23.95)	1.115 (28.32)	.248 (6.30)	.308 (7.83)	.199 (5.05)	.187 (4.75)	.429 (10.90)	.416 (10.57)
37	1.485 (37.72)	1.102 (27.99)	1.093 (27.76)	1.265 (32.13)	.248 (6.30)	.308 (7.83)	.199 (5.05)	.187 (4.75)	.429 (10.90)	.416 (10.57)
51	1.435 (36.45)	1.054 (26.77)	1.041 (26.44)	1.215 (30.86)	.297 (7.54)	.351 (8.92)	.199 (5.05)	.187 (4.75)	.429 (10.90)	.416 (10.57)
100	2.165 (54.99)	1.505 (38.23)	1.442 (36.63)	1.800 (45.72)	.394 (10.00)	.394 (10.00)	.199 (5.05)	.187 (4.75)	.429 (10.90)	.416 (10.57)

















FIELD SOLDERABLE CONNECTOR

- Low Profile Metal Shell Connector w/Solder Cup Contacts
- Environmentally Sealed
- Operating Temperature -50° C to 200° C
- 9 to 51 Contacts Accepting 24 AWG Wire



HOW TO ORDER

* Indicates preferred standard *** Leave blank if no hardware required.

Series	Insulator	Contacts	Contact Gender	Hardware***	Finish**	Temp Range
A = Metal Shell (Receptacle)	R=PPS	09	N= Male / Pin (Plug Side)	*02 (12 for Size 100) 22 (Swaged)	Blank= Cadmium	*Blank =125C
		15				HT = 200C
AP = Metal Shell w/Plastic shroud (Plug)		21	T = Female/Socket (Receptacle Side)	03 (13 for Size 100)	*S01 = Nickel	
		25				
		31	TT = Female/Socket (Receptacle Side) for 24 AWG wire	*05 (15 for Size 100)	S03 = Black Anodize	
		37				
		51-3		06 (16 for Size 100)	S06 = Olive-Drab Cadmium	
		100		07 (17 for Size 100)	S07 = Titanium	
						
					S09 = Stainless	
						

ELECTRICAL PERFORMANCE DATA	Go to Page 9 See chart 18 E or Click Here for Electrical Performance Data
MECHANICAL PERFORMANCE DATA	Go to Page 9 See chart 18 M or Click Here for Mechanical Performance Data
MATERIALS AND FINSHES DATA	Go to Page 9 See chart 18 M&F or Click Here for Materials and Finishes Data

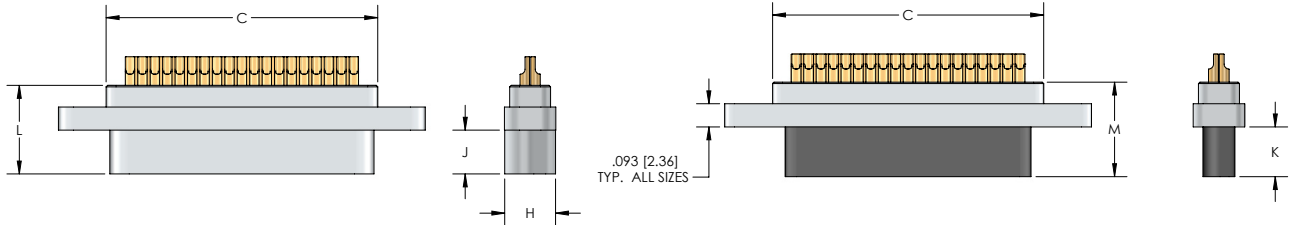

RECEPTACLE (SOCKETS)

PLUG (PINS)

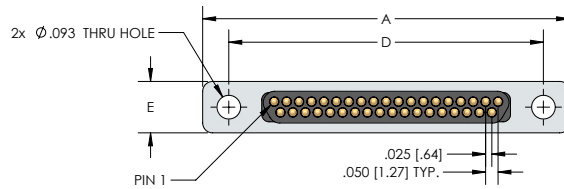
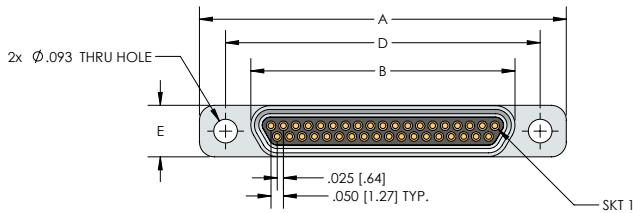

Size	ALL		A SERIES								
	A Max.	B Max.	C Max.	D Max.	H Max.	E Max.	G Max.	J Max. (Skt)	K Max. (Pin)	L Max. (Skt)	M Max. (Pin)
9	.785 (19.94)	.376 (9.55)	.393 (9.98)	.565 (14.35)	.218 (5.54)	.218 (5.54)	.174 (4.42)	.182 (4.62)	.209 (5.31)	.375 (9.57)	.395 (10.03)
15	.935 (23.75)	.526 (13.36)	.543 (13.79)	.715 (18.16)	.218 (5.54)	.218 (5.54)	.174 (4.42)	.182 (4.62)	.209 (5.31)	.375 (9.57)	.395 (10.03)
21	1.085 (27.56)	.693 (17.17)	.693 (17.60)	.865 (21.97)	.218 (5.54)	.218 (5.54)	.174 (4.42)	.182 (4.62)	.209 (5.31)	.375 (9.57)	.395 (10.03)
25	1.185 (30.10)	.776 (19.71)	.793 (20.14)	.965 (24.51)	.218 (5.54)	.218 (5.54)	.174 (4.42)	.182 (4.62)	.209 (5.31)	.375 (9.57)	.395 (10.03)
31	1.335 (33.91)	.926 (23.52)	.943 (23.95)	1.115 (28.32)	.218 (5.54)	.218 (5.54)	.174 (4.42)	.182 (4.62)	.209 (5.31)	.375 (9.57)	.395 (10.03)
37	1.485 (37.72)	1.076 (27.33)	1.093 (27.76)	1.265 (32.13)	.218 (5.54)	.218 (5.54)	.174 (4.42)	.182 (4.62)	.209 (5.31)	.375 (9.57)	.395 (10.03)
51-3	1.435 (36.45)	1.026 (26.06)	1.041 (26.44)	1.215 (30.86)	.254 (6.45)	.254 (6.45)	.223 (5.66)	.182 (4.62)	.209 (5.31)	.375 (9.57)	.395 (10.03)





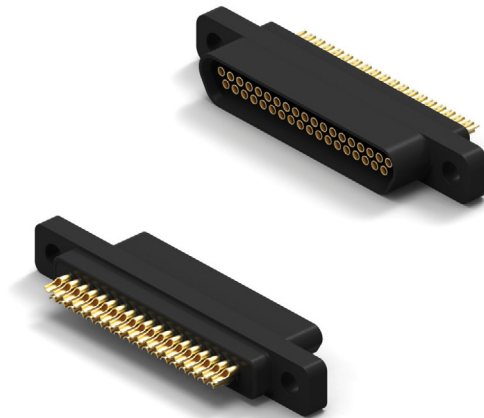

FIELD SOLDERABLE CONNECTOR

- Low Profile Plastic Shell Connector w/Solder Cup Contacts
- Environmentally Sealed
- Operating Temperature -50° C to 200° C
- 9 to 51 Contacts Accepting 24 AWG Wire



HOW TO ORDER

* Indicates preferred standard *** Leave blank if no hardware required.

P	R	51-3	N	Ø	
Series	Insulator	Contacts	Contact Gender	Hardware***	Temp Range
P = Plastic Shell	R=PPS	Ø9	N= Male / Pin (Plug Side)	*Ø2 (12 for Size 1ØØ) 22 (Swaged)	*Blank =125C
		15			HT = 200C
		21	T = Female/Socket (Receptacle Side)	Ø3 (13 for Size 1ØØ)	
		25			
		31	TT = Female/Socket (Receptacle Side) for 24 AWG wire	*Ø5 (15 for Size 1ØØ)	
		37			
		51-3		Ø6 (16 for Size 1ØØ)	
					
				Ø7 (17 for Size 1ØØ)	
					

ELECTRICAL PERFORMANCE DATA	Go to Page 9 See chart 18 E or Click Here for Electrical Performance Data
MECHANICAL PERFORMANCE DATA	Go to Page 9 See chart 18 M or Click Here for Mechanical Performance Data
MATERIALS AND FINISHES DATA	Go to Page 9 See chart 18 M&F or Click Here for Materials and Finishes Data

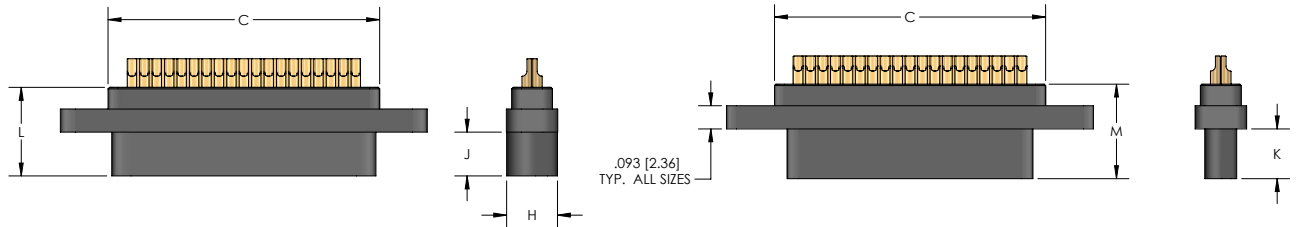

RECEPTACLE (SOCKETS)

PLUG (PINS)

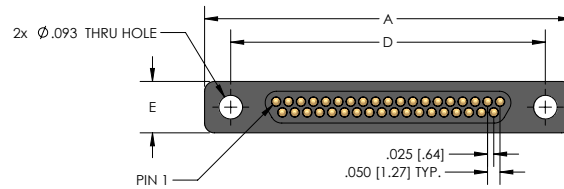
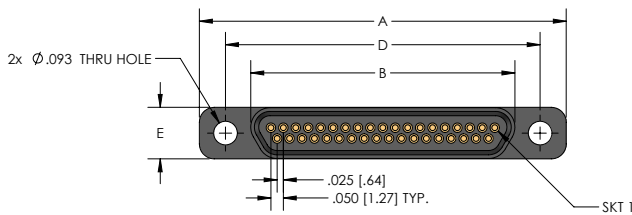

Size	ALL		P SERIES								
	A Max.	B Max.	C Max.	D Max.	H Max.	E Max.	G Max.	J Max. (Skt)	K Max. (Pin)	L Max. (Skt)	M Max. (Pin)
9	.785 (19.94)	.376 (9.55)	.393 (9.98)	.565 (14.35)	.218 (5.54)	.218 (5.54)	.174 (4.42)	.182 (4.62)	.209 (5.31)	.375 (9.57)	.395 (10.03)
15	.935 (23.75)	.526 (13.36)	.543 (13.79)	.715 (18.16)	.218 (5.54)	.218 (5.54)	.174 (4.42)	.182 (4.62)	.209 (5.31)	.375 (9.57)	.395 (10.03)
21	1.085 (27.56)	.693 (17.17)	.693 (17.60)	.865 (21.97)	.218 (5.54)	.218 (5.54)	.174 (4.42)	.182 (4.62)	.209 (5.31)	.375 (9.57)	.395 (10.03)
25	1.185 (30.10)	.776 (19.71)	.793 (20.14)	.965 (24.51)	.218 (5.54)	.218 (5.54)	.174 (4.42)	.182 (4.62)	.209 (5.31)	.375 (9.57)	.395 (10.03)
31	1.335 (33.91)	.926 (23.52)	.943 (23.95)	1.115 (28.32)	.218 (5.54)	.218 (5.54)	.174 (4.42)	.182 (4.62)	.209 (5.31)	.375 (9.57)	.395 (10.03)
37	1.485 (37.72)	1.076 (27.33)	1.093 (27.76)	1.265 (32.13)	.218 (5.54)	.218 (5.54)	.174 (4.42)	.182 (4.62)	.209 (5.31)	.375 (9.57)	.395 (10.03)
51-3	1.435 (36.45)	1.026 (26.06)	1.041 (26.44)	1.215 (30.86)	.254 (6.45)	.254 (6.45)	.223 (5.66)	.182 (4.62)	.209 (5.31)	.375 (9.57)	.395 (10.03)

NANO-D SERIES

WIRED

SINGLE ROW-SINGLE ENDED-METAL SHELL	34
SINGLE ROW-DOUBLE ENDED-METAL SHELL	36
DUAL ROW-SINGLE ENDED-METAL SHELL	38
DUAL ROW-SINGLE ENDED-PLASTIC SHELL	40
DUAL ROW-DOUBLE ENDED-METAL SHELL	42
DUAL ROW-DOUBLE ENDED-PLASTIC SHELL	44

NANO D

PERFORMANCE DATA

123-E	ELECTRICAL
CONTACT RESISTANCE:	.080 mΩ max.@ 1.0 A
CURRENT RATING (SIGNAL CONTACTS):	1.0 A max.
DIELECTRIC WITHSTANDING VOLTAGE:	250 VAC at sea level , 100 VAC at 70,000 ft.
INSULATION RESISTANCE:	5,000 MΩ min..

123-M	MECHANICAL
CONTACT ENGAGING FORCE:	5 oz max. (Contact average is 2 oz.)
CONTACT SEPARATING FORCE:	0.4 oz. min.
CONNECTOR MATING FORCE:	7 oz. x number of contacts max.
CONNECTOR UNMATING FORCE:	7 oz. x number of contacts max.
VIBRATION:	No damage or interruption detected (one microsecond sensitivity) EIA-364-28 Condition IV
SHOCK:	No damage or interruption detected (one microsecond sensitivity) EIA-364-28 Condition IV
DURABILITY:	No mechanical or electrical defects after 500 matings.
SALT SPRAY:	No exposure of base metal or loss of performance after 96 hours for both Nickel and Cadmium plating

MATERIALS AND FINISHES

123-M&F	MATERIALS AND FINISHES
Pin Contacts	Pins: BeCu alloy strip per ASTM-B-194
Socket Contacts	Sockets: BeCu per ASTM-B-194
Contact Plating	Gold plate per ASTM B488, or SAE AMS 2422
Metal Shells	Aluminum alloy per SAE-AMS-QQ-A-200/8, Type 6061-T6, with electroless nickel SAE AMS2404, class 3 or 4 or electrodeposited cadmium plating per SAE-AMS-QQ-P-416, Type II, class 3, with Yellow Chromate or Anodize per Mil-A-8625, Type III, Class 2, Black, Stainless Steel per ASTM A582, Titanium Alloy per MIL-T-81556, Unplated
Molded Insulators into Metal housing	Insulating compound per MIL-I-16923. Liquid Crystal Polymer (LCP), per MIL-M-24519 GLCP-30F, 30% Glass
Hardware	Corrosion resistant steel per ASTM A 582/A582 or ASTM A 581/A581M, Passivated per SAE AMS-2700

126-M&F	MATERIALS AND FINISHES
Pin Contacts	Pins: BeCu alloy strip per ASTM-B-194
Socket Contacts	Sockets: BeCu per ASTM-B-194
Contact Plating	Gold plate per ASTM B488, or SAE AMS 2422
Molded Full plastic housing:	Insulating compound per MIL-I-16923. Liquid Crystal Polymer (LCP), per MIL-M-24519 GLCP-30F, 30% Glass
Hardware	Corrosion resistant steel per ASTM A 582/A582 or ASTM A 581/A581M, Passivated per SAE AMS-2700

NANO-D SERIES

CIRCUIT RIGHT ANGLE

SINGLE ROW-PLATED THRU HOLE-METAL SHELL	46
SINGLE ROW-SURFACE MOUNT-METAL SHELL	50
DUAL ROW-PLATED THRU HOLE-METAL SHELL.....	54
DUAL ROW-PLATED THRU HOLE-PLASTIC SHELL.....	58
DUAL ROW-SURFACE MOUNT-METAL SHELL.....	62
DUAL ROW-SURFACE MOUNT-PLASTIC SHELL.....	66
DUAL ROW-(EXTEND PROFILE-FEMALE ONLY) SURFACE MOUNT-METAL SHELL.....	70
DUAL ROW-(EXTEND PROFILE-FEMALE ONLY) SURFACE MOUNT-PLASTIC SHELL.....	74

PERFORMANCE DATA

133-E	ELECTRICAL
CONTACT RESISTANCE:	0.033 mΩ max.@ 1.0 A
CURRENT RATING (SIGNAL CONTACTS):	1.0 A max.
DIELECTRIC WITHSTANDING VOLTAGE:	250 VAC at sea level , 100 VAC at 70,000 ft.
INSULATION RESISTANCE:	5,000 MΩ min.

123-M	MECHANICAL
CONTACT ENGAGING FORCE:	5 oz max. (Contact average is 2 oz.)
CONTACT SEPARATING FORCE:	0.4 oz. min.
CONNECTOR MATING FORCE:	7 oz. x number of contacts max.
CONNECTOR UNMATING FORCE:	7 oz. x number of contacts max.
VIBRATION:	No damage or interruption detected (one microsecond sensitivity) EIA-364-28 Condition IV
SHOCK:	No damage or interruption detected (one microsecond sensitivity) EIA-364-28 Condition IV
DURABILITY:	No mechanical or electrical defects after 500 matings.
SALT SPRAY:	No exposure of base metal or loss of performance after 96 hours for both Nickel and Cadmium plating

MATERIALS AND FINISHES

131-M&F	MATERIALS AND FINISHES
Pin Contacts	Pins: BeCu alloy strip per ASTM-B-194
Socket Contacts	Sockets: BeCu per ASTM-B-194
Contact Plating	Gold plate per ASTM B488, or SAE AMS 2422
Metal Shells	Aluminum alloy per SAE-AMS-QQ-A-200/8, Type 6061-T6, with electroless nickel SAE AMS2404, class 3 or 4 or electrodeposited cadmium plating per SAE-AMS-QQ-P-416, Type II, class 3, with Yellow Chromate or Anodize per Mil-A-8625, Type III, Class 2, Black, Stainless Steel per ASTM A582, Titanium Alloy per MIL-T-81556, Unplated
Molded Insulators into Metal housing	Insulating compound per MIL-I-16923. Liquid Crystal Polymer (LCP), per MIL-M-24519 GLCP-30F, 30% Glass
Alignment Post	Corrosion resistant steel per ASTM A 582/A582 or ASTM A 581/A581M, Passivated per SAE AMS-2700

126-M&F	MATERIALS AND FINISHES
Pin Contacts	Pins: BeCu alloy strip per ASTM-B-194
Socket Contacts	Sockets: BeCu per ASTM-B-194
Contact Plating	Gold plate per ASTM B488, or SAE AMS 2422
Molded Full plastic housing:	Insulating compound per MIL-I-16923. Liquid Crystal Polymer (LCP), per MIL-M-24519 GLCP-30F, 30% Glass
Hardware	Corrosion resistant steel per ASTM A 582/A582 or ASTM A 581/A581M, Passivated per SAE AMS-2700

NANO-D SERIES

CIRCUIT

SINGLE ROW-PLATED THRU HOLE-METAL SHELL	78
SINGLE ROW-SURFACE MOUNT-METAL SHELL	82

PERFORMANCE DATA

133-E	ELECTRICAL
CONTACT RESISTANCE:	0.033 mΩ max.@ 1.0 A
CURRENT RATING (SIGNAL CONTACTS):	1.0 A max.
DIELECTRIC WITHSTANDING VOLTAGE:	250 VAC at sea level , 100 VAC at 70,000 ft.
INSULATION RESISTANCE:	5,000 MΩ min.

123-M	MECHANICAL
CONTACT ENGAGING FORCE:	5 oz max. (Contact average is 2 oz.)
CONTACT SEPARATING FORCE:	0.4 oz. min.
CONNECTOR MATING FORCE:	7 oz. x number of contacts max.
CONNECTOR UNMATING FORCE:	7 oz. x number of contacts max.
VIBRATION:	No damage or interruption detected (one microsecond sensitivity) EIA-364-28 Condition IV
SHOCK:	No damage or interruption detected (one microsecond sensitivity) EIA-364-28 Condition IV
DURABILITY:	No mechanical or electrical defects after 500 matings.
SALT SPRAY:	No exposure of base metal or loss of performance after 96 hours for both Nickel and Cadmium plating

MATERIALS AND FINISHES

145-M&F	MATERIALS AND FINISHES
Pin Contacts	Pins: BeCu alloy strip per ASTM-B-194
Contact Plating	Gold plate per ASTM B488, or SAE AMS 2422
Metal Shells	Aluminum alloy per SAE-AMS-QQ-A-200/8, Type 6061-T6, with electroless nickel SAE AMS2404, class 3 or 4 or electrodeposited cadmium plating per SAE-AMS-QQ-P-416, Type II, class 3, with Yellow Chromate or Anodize per Mil-A-8625, Type III, Class 2, Black, Stainless Steel per ASTM A582, Titanium Alloy per MIL-T-81556, Unplated
Molded Insulators into Metal Housing	Insulating compound per MIL-I-16923. Liquid Crystal Polymer (LCP), per MIL-M-24519 GLCP-30F, 30% Glass

146-M&F	MATERIALS AND FINISHES
Pin Contacts	Pins: BeCu alloy strip per ASTM-B-194
Contact Plating	Gold plate per ASTM B488, or SAE AMS 2422
Molded Full Plastic Housing:	Insulating compound per MIL-I-16923. Liquid Crystal Polymer (LCP), per MIL-M-24519 GLCP-30F, 30% Glass
Hardware	Corrosion resistant steel per ASTM A 582/A582 or ASTM A 581/A581M, Passivated per SAE AMS-2700

NANO-D SERIES

CIRCUIT

DUAL ROW-PLATED THRU HOLE-METAL SHELL.....	86
DUAL ROW-PLATED THRU HOLE-PLASTIC SHELL.....	90
DUAL ROW-SURFACE MOUNT-METAL SHELL.....	94
DUAL ROW-SURFACE MOUNT-PLASTIC SHELL.....	96
DUAL ROW-(LOW PROFILE-MALE ONLY) SURFACE MOUNT-METAL SHELL.....	102
DUAL ROW-(LOW PROFILE-MALE ONLY) SURFACE MOUNT-PLASTIC SHELL.....	106

PERFORMANCE DATA

133-E	ELECTRICAL
CONTACT RESISTANCE:	0.033 mΩ max.@ 1.0 A
CURRENT RATING (SIGNAL CONTACTS):	1.0 A max.
DIELECTRIC WITHSTANDING VOLTAGE:	250 VAC at sea level , 100 VAC at 70,000 ft.
INSULATION RESISTANCE:	5,000 MΩ min.

123-M	MECHANICAL
CONTACT ENGAGING FORCE:	5 oz max. (Contact average is 2 oz.)
CONTACT SEPARATING FORCE:	0.4 oz. min.
CONNECTOR MATING FORCE:	7 oz. x number of contacts max.
CONNECTOR UNMATING FORCE:	7 oz. x number of contacts max.
VIBRATION:	No damage or interruption detected (one microsecond sensitivity) EIA-364-28 Condition IV
SHOCK:	No damage or interruption detected (one microsecond sensitivity) EIA-364-28 Condition IV
DURABILITY:	No mechanical or electrical defects after 500 matings.
SALT SPRAY:	No exposure of base metal or loss of performance after 96 hours for both Nickel and Cadmium plating

MATERIALS AND FINISHES

139 -M&F	MATERIALS AND FINISHES
Pin Contacts	Pins: BeCu alloy strip per ASTM-B-194
Socket Contacts	Sockets: BeCu per ASTM-B-194
Contact Plating	Gold plate per ASTM B488, or SAE AMS 2422
Metal Shells	Aluminum alloy per SAE-AMS-QQ-A-200/8, Type 6061-T6, with electroless nickel SAE AMS2404, class 3 or 4 or electrodeposited cadmium plating per SAE-AMS-QQ-P-416, Type II, class 3, with Yellow Chromate or Anodize per Mil-A-8625, Type III, Class 2, Black, Stainless Steel per ASTM A582, Titanium Alloy per MIL-T-81556, Unplated
Molded Insulators into Metal Housing	Insulating compound per MIL-I-16923. Liquid Crystal Polymer (LCP), per MIL-M-24519 GLCP-30F, 30% Glass

142 144-M&F	MATERIALS AND FINISHES
Pin Contacts	Pins: BeCu alloy strip per ASTM-B-194
Socket Contacts	Sockets: BeCu per ASTM-B-194
Contact Plating	Gold plate per ASTM B488, or SAE AMS 2422
Molded Full Plastic Housing:	Insulating compound per MIL-I-16923. Liquid Crystal Polymer (LCP), per MIL-M-24519 GLCP-30F, 30% Glass
Hardware	Corrosion resistant steel per ASTM A 582/A582 or ASTM A 581/A581M, Passivated per SAE AMS-2700

NANO-D SERIES

LATCHING

WIRED

DUAL ROW-SINGLE ENDED-METAL SHELL.....	110
DUAL ROW-DOUBLE ENDED-METAL SHELL.....	112

PERFORMANCE DATA

123-E	ELECTRICAL
CONTACT RESISTANCE:	.080 mΩ max.@ 1.0 A
CURRENT RATING (SIGNAL CONTACTS):	1.0 A max.
DIELECTRIC WITHSTANDING VOLTAGE:	250 VAC at sea level , 100 VAC at 70,000 ft.
INSULATION RESISTANCE:	5,000 MΩ min..

123-M	MECHANICAL
CONTACT ENGAGING FORCE:	5 oz max. (Contact average is 2 oz.)
CONTACT SEPARATING FORCE:	0.4 oz. min.
CONNECTOR MATING FORCE:	7 oz. x number of contacts max.
CONNECTOR UNMATING FORCE:	7 oz. x number of contacts max.
VIBRATION:	No damage or interruption detected (one microsecond sensitivity) EIA-364-28 Condition IV
SHOCK:	No damage or interruption detected (one microsecond sensitivity) EIA-364-28 Condition IV
DURABILITY:	No mechanical or electrical defects after 500 matings.
SALT SPRAY:	No exposure of base metal or loss of performance after 96 hours for both Nickel and Cadmium plating

MATERIALS AND FINISHES

149-M&F	MATERIALS AND FINISHES
Pin Contacts	Pins: BeCu alloy strip per ASTM-B-194
Socket Contacts	Sockets: BeCu per ASTM-B-194
Contact Plating	Gold plate per ASTM B488, or SAE AMS 2422
Metal Shells	Aluminum alloy per SAE-AMS-QQ-A-200/8, Type 6061-T6, with electroless nickel SAE AMS2404, class 3 or 4 or electrodeposited cadmium plating per SAE-AMS-QQ-P-416, Type II, class 3, with Yellow Chromate or Anodize per Mil-A-8625, Type III, Class 2, Black, Stainless Steel per ASTM A582, Titanium Alloy per MIL-T-81556, Unplated
Molded Insulators into Metal housing	Insulating compound per MIL-I-16923. Liquid Crystal Polymer (LCP), per MIL-M-24519 GLCP-30F, 30% Glass
Hardware	Polyphenylene Sulfide (PPS), per MIL-M-24519 GST-40F, 40% Glass

NANO-D SERIES

LATCHING CIRCUIT

DUAL ROW-VERTICAL-PLATED THRU HOLE-METAL SHELL.....	114
DUAL ROW-VERTICAL-SURFACE MOUNT-METAL SHELL.....	118
DUAL ROW-RIGHT ANGLE-PLATED THRU HOLE-METAL SHELL.....	122
DUAL ROW-RIGHT ANGLE-SURFACE MOUNT-METAL SHELL.....	126
DUAL ROW-RIGHT ANGLE-SURFACE MOUNT-(EXTEND PROFILE,FEMALE ONLY)-METAL SHELL.....	130

PERFORMANCE DATA

133-E	ELECTRICAL
CONTACT RESISTANCE:	0.033 mΩ max. @ 1.0 A
CURRENT RATING (SIGNAL CONTACTS):	1.0 A max.
DIELECTRIC WITHSTANDING VOLTAGE:	250 VAC at sea level , 100 VAC at 70,000 ft.
INSULATION RESISTANCE:	5,000 MΩ min.

123-M	MECHANICAL
CONTACT ENGAGING FORCE:	5 oz max. (Contact average is 2 oz.)
CONTACT SEPARATING FORCE:	0.4 oz. min.
CONNECTOR MATING FORCE:	7 oz. x number of contacts max.
CONNECTOR UNMATING FORCE:	7 oz. x number of contacts max.
VIBRATION:	No damage or interruption detected (one microsecond sensitivity) EIA-364-28 Condition IV
SHOCK:	No damage or interruption detected (one microsecond sensitivity) EIA-364-28 Condition IV
DURABILITY:	No mechanical or electrical defects after 500 matings.
SALT SPRAY:	No exposure of base metal or loss of performance after 96 hours for both Nickel and Cadmium plating

MATERIALS AND FINISHES

131-M&F	MATERIALS AND FINISHES
Pin Contacts	Pins: BeCu alloy strip per ASTM-B-194
Socket Contacts	Sockets: BeCu per ASTM-B-194
Contact Plating	Gold plate per ASTM B488, or SAE AMS 2422
Metal Shells	Aluminum alloy per SAE-AMS-QQ-A-200/8, Type 6061-T6, with electroless nickel SAE AMS2404, class 3 or 4 or electrodeposited cadmium plating per SAE-AMS-QQ-P-416, Type II, class 3, with Yellow Chromate or Anodize per Mil-A-8625, Type III, Class 2, Black, Stainless Steel per ASTM A582, Titanium Alloy per MIL-T-81556, Unplated
Molded Insulators into Metal housing	Insulating compound per MIL-I-16923. Liquid Crystal Polymer (LCP), per MIL-M-24519 GLCP-30F, 30% Glass
Alignment Post	Corrosion resistant steel per ASTM A 582/A582 or ASTM A 581/A581M, Passivated per SAE AMS-2700

NANO-D SERIES

FIELD ATTACHABLE

DUAL ROW-METAL SHELL.....	134
DUAL ROW-PLASTIC SHELL.....	136
CIRCULAR INLINE-PLASTIC SHELL.....	138

PERFORMANCE DATA

133-E	ELECTRICAL
CONTACT RESISTANCE:	0.033 mΩ max.@ 1.0 A
CURRENT RATING (SIGNAL CONTACTS):	1.0 A max.
DIELECTRIC WITHSTANDING VOLTAGE:	250 VAC at sea level , 100 VAC at 70,000 ft.
INSULATION RESISTANCE:	5,000 MΩ min.

123-M	MECHANICAL
CONTACT ENGAGING FORCE:	5 oz max. (Contact average is 2 oz.)
CONTACT SEPARATING FORCE:	0.4 oz. min.
CONNECTOR MATING FORCE:	7 oz. x number of contacts max.
CONNECTOR UNMATING FORCE:	7 oz. x number of contacts max.
VIBRATION:	No damage or interruption detected (one microsecond sensitivity) EIA-364-28 Condition IV
SHOCK:	No damage or interruption detected (one microsecond sensitivity) EIA-364-28 Condition IV
DURABILITY:	No mechanical or electrical defects after 500 matings.
SALT SPRAY:	No exposure of base metal or loss of performance after 96 hours for both Nickel and Cadmium plating

MATERIALS AND FINISHES

126-M&F	MATERIALS AND FINISHES
Pin Contacts	Pins: BeCu alloy strip per ASTM-B-194
Socket Contacts	Sockets: BeCu per ASTM-B-194
Contact Plating	Gold plate per ASTM B488, or SAE AMS 2422
Molded Full plastic housing:	Insulating compound per MIL-I-16923. Liquid Crystal Polymer (LCP), per MIL-M-24519 GLCP-30F, 30% Glass
Hardware	Corrosion resistant steel per ASTM A 582/A582 or ASTM A 581/A581M, Passivated per SAE AMS-2700

NANO-D SERIES

CIRCULAR WIRED

METAL BREAK AWAY WIRED-INLINE	140
PLASTIC WIRED-INLINE.....	142

PERFORMANCE DATA

123-E	ELECTRICAL
CONTACT RESISTANCE:	.080 mΩ max. @ 1.0 A
CURRENT RATING (SIGNAL CONTACTS):	1.0 A max.
DIELECTRIC WITHSTANDING VOLTAGE:	250 VAC at sea level, 100 VAC at 70,000 ft.
INSULATION RESISTANCE:	5,000 MΩ min..

123-M	MECHANICAL
CONTACT ENGAGING FORCE:	5 oz max. (Contact average is 2 oz.)
CONTACT SEPARATING FORCE:	0.4 oz. min.
CONNECTOR MATING FORCE:	7 oz. x number of contacts max.
CONNECTOR UNMATING FORCE:	7 oz. x number of contacts max.
VIBRATION:	No damage or interruption detected (one microsecond sensitivity) EIA-364-28 Condition IV
SHOCK:	No damage or interruption detected (one microsecond sensitivity) EIA-364-28 Condition IV
DURABILITY:	No mechanical or electrical defects after 500 matings.
SALT SPRAY:	No exposure of base metal or loss of performance after 96 hours for both Nickel and Cadmium plating

MATERIALS AND FINISHES

122-M&F	MATERIALS AND FINISHES
Pin Contacts	Pins: BeCu alloy strip per ASTM-B-194
Socket Contacts	Sockets: BeCu per ASTM-B-194
Contact Plating	Gold plate per ASTM B488, or SAE AMS 2422
Metal Shells	Aluminum alloy per SAE-AMS-QQ-A-200/8, Type 6061-T6, with electroless nickel SAE AMS2404, class 3 or 4 or electrodeposited cadmium plating per SAE-AMS-QQ-P-416, Type II, class 3, with Yellow Chromate or Anodize per Mil-A-8625, Type III, Class 2, Black, Stainless Steel per ASTM A582, Titanium Alloy per MIL-T-81556, Unplated
Molded Insulators into Metal housing	Insulating compound per MIL-I-16923. Liquid Crystal Polymer (LCP), per MIL-M-24519 GLCP-30F, 30% Glass
Hardware	Corrosion resistant steel per ASTM A 582/A582 or ASTM A 581/A581M, Passivated per SAE AMS-2700

113-M&F	MATERIALS AND FINISHES
Pin Contacts	Pins: BeCu alloy strip per ASTM-B-194
Socket Contacts	Sockets: BeCu per ASTM-B-194
Contact Plating	Gold plate per ASTM B488, or SAE AMS 2422
Metal Shells	Aluminum alloy per SAE-AMS-QQ-A-200/8, Type 6061-T6, with electroless nickel SAE AMS2404, class 3 or 4 or Anodize per Mil-A-8625, Type III, Class 2, Black, Stainless Steel per ASTM A582 Passivated per SAE AMS-2700
Molded Insulators	Insulating compound per MIL-I-16923. Liquid Crystal Polymer (LCP), per MIL-M-24519 GLCP-30F, 30% Glass

WIRED CONNECTOR















- Metal Shell Connector w/Wire Leads
- Operating Temperature -50° C to 200° C
- 9 to 51 Contacts



HOW TO ORDER

* Indicates preferred standard ** Consult factory for other plating options

N M L 25 - 1 P Ø2 - 3Ø F 6 - 18.Ø - SØ1

N	M	L	25	1	P	Ø2	3Ø	F	6	18.Ø	SØ1	
Series	Insulator	Contacts	Insulator Type	Contact Gender	Hardware***	Wire Gauge	Wire Type	Color Code	Length	Finish**	Temp Range	
N = Nano	M = Metal	L = LCP	Ø9	1 = Single Row	P = Male/Pin (Plug Side)	Ø1 = Phillips Head Jackscrew	3Ø*	C = Solid Wire, uninsulated	1 = White	*18.Ø	Blank = Cadmium	*blank = 125C
			15				32	*F = Stranded, w/Teflon insulation, per NEMA HP3-ET	3 = Tin plated (6Ø/4Ø) (solid wire)	*36.Ø		HT = 2ØØ°C
			21		S = Female/Socket (Receptacle Side)	Ø2 = Allen Head Jackscrew	34	Y = Stranded w/Tefzel insulation, per SAE AS22759/33	4 = Gold plated (RoHS) (solid wire)		*SØ1 = Nickel	
			25					A = Stranded, per DSCC Ø4Ø47-3ØA (White, 3Ø AWG only)	*6 = 10 solid colors, repeating			
			31			Ø5 = Slotted Head Jackscrew		T = Flat Integral Tail			SØ3 = Black Anodize	
			37									
			51			Ø6 = Floating Phillips Head Jackscrew (Female Only)					SØ6 = Olive-Drab Cadmium	
												
						Ø7 = Threaded Hole					SØ7 = Titanium	
												
						Ø8 = Floating Allen Head Jackscrew (Female Only)					SØ9 = Stainless	
												
						Ø9 = Floating Slotted Head Jackscrew (Female Only)						
												

MECHANICAL PERFORMANCE DATA	Go to Page 26 See chart 123 E or Click Here for Mechanical Performance Data
ELECTRICAL PERFORMANCE DATA	Go to Page 26 See chart 123 M or Click Here for Electrical Performance Data
MATERIALS DATA	Go to Page 26 See chart 123 M&F or Click Here for Materials and Finishes Data

NANO D – PID 123

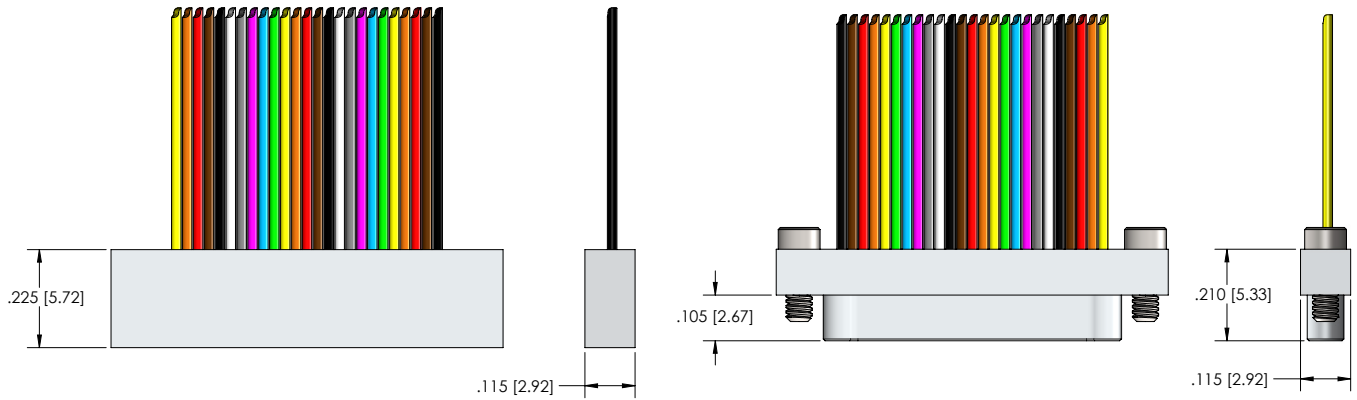

RECEPTACLE (SOCKETS)

PLUG (PINS)

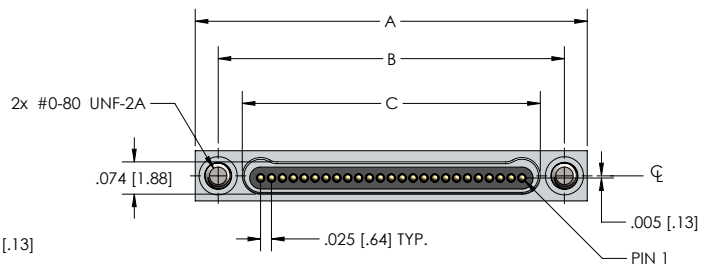
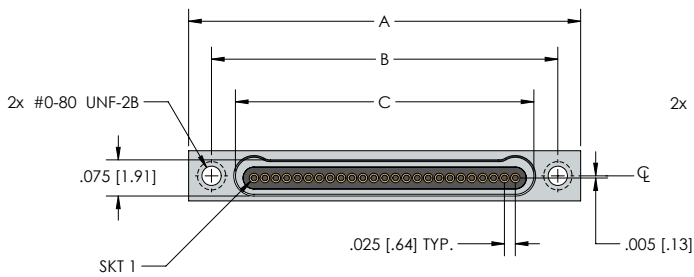

NM SERIES				
Size	A	B	Plug C	Receptacle
9	.500 [12.70]	.395 [10.03]	.284 [7.21]	.285 [7.24]
15	.650 [16.51]	.545 [13.84]	.434 [11.02]	.435 [11.05]
21	.800 [20.32]	.695 [17.65]	.584 [14.83]	.585 [14.86]
25	.900 [22.86]	.795 [20.19]	.684 [17.37]	.685 [17.40]
31	1.050 [26.67]	.945 [24.00]	.834 [21.18]	.835 [21.21]
37	1.200 [30.48]	1.095 [27.81]	.984 [24.99]	.985 [25.02]
51	1.550 [39.37]	1.445 [36.70]	1.334 [33.88]	1.335 [33.91]

WIRED CONNECTOR

- Metal Shell Connector w/Wire Leads
- Operating Temperature -50° C to 200° C
- 9 to 51 Contacts

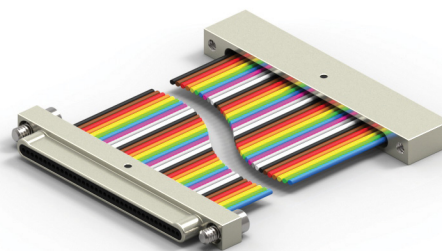

HOW TO ORDER

* Indicates preferred standard ** Consult factory for other plating options

NANO D – PID 124

N	M	L	25	-	1	P	Ø2	/NMLX-1XX	-	3Ø	F	6	-	18.Ø	-	SØ1
Series	Insulator	Contacts	Insulator Type	Contact Gender	Hardware	Detail of Other End of the Harness	Wire Gauge	Wire Type	Color Code	Length	Finish**	Temp Range				
N= Nano	M= Metal	L= LCP	Ø9	1= Single Row	P= Male/Pin (Plug Side)	Ø1=Phillips Head Jackscrew	Refer to the left columns for filling out the x	*F=Stranded, w/ Teflon insulation, per NEMA HP3-ET	1=White	*18.Ø	Blank= Cadmium	*blank = 125C				
		15				Ø1=Phillips Head Jackscrew		32	Y=Stranded w/ Tefzel insulation, per SAE AS22759/33	*6 = 10 solid colors, repeating	*36.Ø		HT = 200°C			
		21		S= Female/Socket (Receptacle Side)	Ø2=Allen Head Jackscrew			34	A=Stranded, per DSCC Ø4Ø47-3ØA (White, 3Ø AWG only)			*SØ1 = Nickel				
		25														
		31			Ø5=Slotted Head Jackscrew							SØ6 = Olive Drab Cadmium				
		37														
		51			Ø6=Floating Phillips Head Jackscrew (Female Only)							SØ7 = Titanium				
					Ø7=Threaded Hole							SØ9 = Stainless				
					Ø8=Floating Allen Head Jackscrew (Female Only)											
					Ø9=Floating Slotted Head Jackscrew (Female Only)											

MECHANICAL PERFORMANCE DATA	Go to Page 26 See chart 123 E or Click Here for Mechanical Performance Data
ELECTRICAL PERFORMANCE DATA	Go to Page 26 See chart 123 M or Click Here for Electrical Performance Data
MATERIALS DATA	Go to Page 26 See chart 123 M&F or Click Here for Materials and Finishes Data

DIMENSIONS

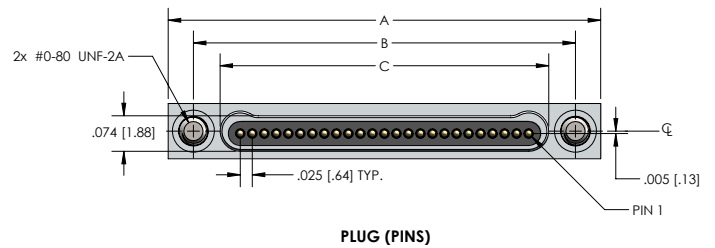
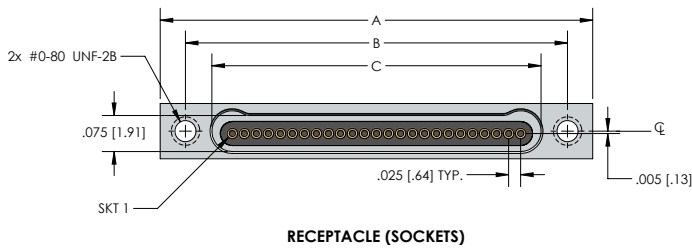
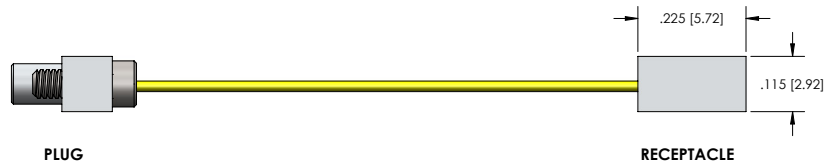
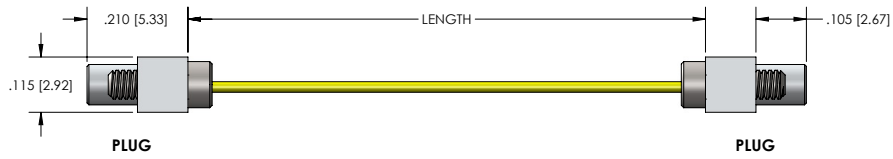

NM SERIES				
Size	A	B	Plug	C Receptacle
9	.500 [12.70]	.395 [10.03]	.284 [7.21]	.285 [7.24]
15	.650 [16.51]	.545 [13.84]	.434 [11.02]	.435 [11.05]
21	.800 [20.32]	.695 [17.65]	.584 [14.83]	.585 [14.86]
25	.900 [22.86]	.795 [20.19]	.684 [17.37]	.685 [17.40]
31	1.050 [26.67]	.945 [24.00]	.834 [21.18]	.835 [21.21]
37	1.200 [30.48]	1.095 [27.81]	.984 [24.99]	.985 [25.02]
51	1.550 [39.37]	1.445 [36.70]	1.334 [33.88]	1.335 [33.91]

WIRED CONNECTOR



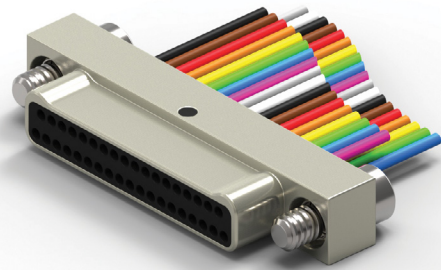













- Metal Shell Connector w/Wire Leads
- Operating Temperature -50° C to 200° C
- 9 to 65 Contacts



HOW TO ORDER

* Indicates preferred standard ** Consult factory for other plating options

N M L 25 -2 P Ø2 - 3Ø F 6 - 18.Ø - SØ1

N	M	L	25	-2	P	Ø2	- 3Ø	F	6	- 18.Ø	- SØ1	Temp Range
Series	Insulator	Contacts	Insulator Type	Contact Gender	Hardware	Wire Gauge	Wire Type	Color Code	Length	Finish**		
N= Nano	M= Metal	L=LCP	Ø9	2= Dual Row	P=Male/Pin (Plug Side)	Ø1=Phillips Head Jackscrew	3Ø*	C=Solid Wire, uninsulated	1=White	*18.Ø	Blank= Cadmium	*blank = 125C
			15				32	*F=Stranded, w/ Teflon insulation, per NEMA HP3-ET	3= Tin plated (6Ø/4Ø) (solid wire)	*36.Ø		HT = 2ØØ°C
			21		S=Female/Socket (Receptacle Side)	Ø2=Allen Head Jackscrew	34	Y=Stranded w/Tefzel insulation, per SAE AS22759/33	4=Gold plated (RoHS) (solid wire)		*SØ1 = Nickel	
			25					A=Stranded, per DSCC Ø4Ø47-3ØA (White, 3Ø AWG only)	*6 = 10 solid colors, repeating			
			31			Ø5=Slotted Head Jackscrew		T=Flat Integral Tail			SØ3 = Black Anodize	
			37									
			51			Ø6=Floating Phillips Head Jackscrew (Female Only)					SØ6 = Olive-Drab Cadmium	
			65									
						Ø7=Threaded Hole					SØ7 = Titanium	
												
						Ø8=Floating Allen Head Jackscrew (Female Only)					SØ9 = Stainless	
												
						Ø9=Floating Slotted Head Jackscrew (Female Only)						
												

MECHANICAL PERFORMANCE DATA	Go to Page 26 See chart 123 E or Click Here for Mechanical Performance Data
ELECTRICAL PERFORMANCE DATA	Go to Page 26 See chart 123 M or Click Here for Electrical Performance Data
MATERIALS DATA	Go to Page 26 See chart 123 M&F or Click Here for Materials and Finishes Data

NANO D – PID 125

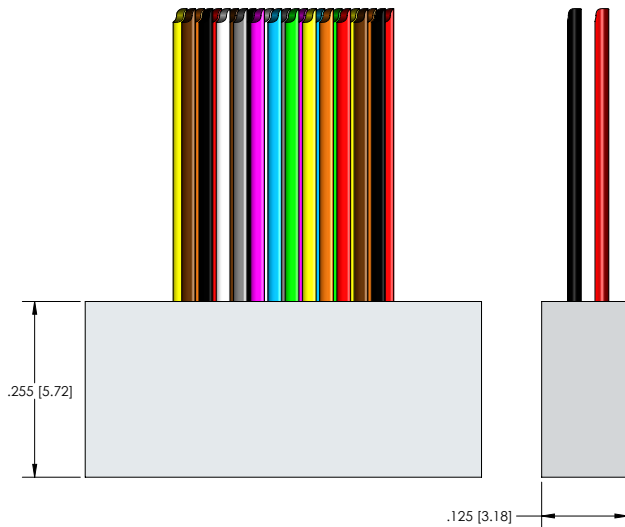

RECEPTACLE (SOCKETS)

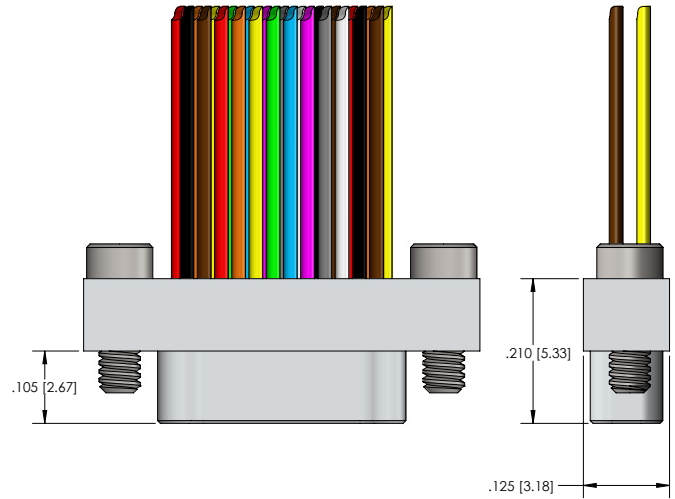

PLUG (PINS)

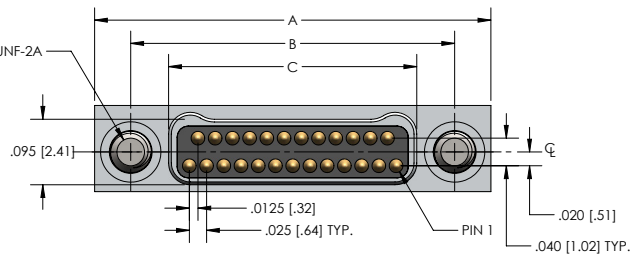
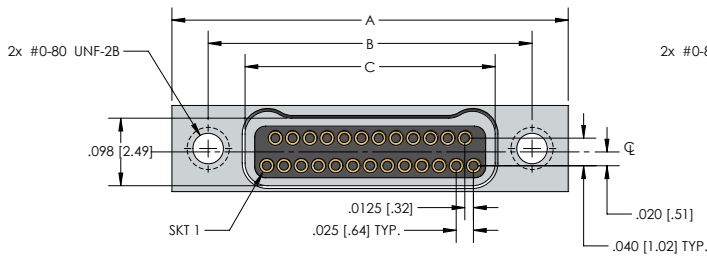

Size	NM SERIES				
	A	B	Plug	C	Receptacle
9	.375 [9.52]	.270 [6.86]	.160 [4.06]		.163 [4.14]
15	.450 [11.43]	.345 [8.76]	.235 [5.97]		.238 [6.04]
21	.525 [13.33]	.420 [10.67]	.310 [7.87]		.313 [7.95]
25	.575 [14.60]	.470 [11.94]	.360 [9.14]		.363 [9.22]
31	.650 [16.51]	.545 [13.84]	.435 [11.05]		.438 [11.12]
37	.725 [18.41]	.620 [15.75]	.510 [12.95]		.513 [13.03]
51	.900 [22.86]	.795 [20.19]	.685 [17.40]		.688 [17.47]
65	1.075 [27.30]	.970 [24.64]	.860 [21.84]		.863 [21.92]

WIRED CONNECTOR









- Plastic Shell Connector w/Wire Leads
- Operating Temperature -50° C to 200° C
- 9 to 65 Contacts



HOW TO ORDER

* Indicates preferred standard

NANO D – PID 126

N	P	L	25	-	2	P	Ø2	-	3Ø	F	6	-	18.Ø
Series	Insulator	Contacts	Insulator Type	Contact Gender	Hardware	Wire Gauge	Wire Type	Color Code	Length	Temp Range			
N= Nano	P= Plastic	L=LCP	Ø9	2= Dual Row	P=Male/Pin (Plug Side)	Ø1=Phillips Head Jackscrew	3Ø*	C=Solid Wire, uninsulated	1=White	*18.Ø	*blank = 125C		
			15				32	*F=Stranded, w/Teflon insulation, per NEMA HP3-ET	3=Tin plated (6Ø/4Ø) (Solid Wire)	*36.Ø	HT = 2ØØ°C		
			21		S=Female/Socket (Receptacle Side)	Ø2=Allen Head Jackscrew	34	Y=Stranded w/Tefzel insulation, per SAE AS22759/33	4=Gold plated (RoHS) (Solid Wire)				
			25					A=Stranded, per DSCC Ø4Ø47-3ØA (White, 3Ø AWG only)	*6 = 10 solid colors, repeating				
			31			Ø5=Slotted Head Jackscrew		"T=Flat Integral Tail					
			37										
			51			Ø6=Floating Phillips Head Jackscrew (Female Only)							
			65										
						Ø7=Threaded Hole							
													
						Ø8=Floating Allen Head Jackscrew (Female Only)							
													
						Ø9=Floating Slotted Head Jackscrew (Female Only)							
													

MECHANICAL PERFORMANCE DATA	Go to Page 26 See chart 123 M or Click Here for Mechanical Performance Data
ELECTRICAL PERFORMANCE DATA	Go to Page 26 See chart 123 E or Click Here for Electrical Performance Data
MATERIALS DATA	Go to Page 26 See chart 126 M&F or Click Here for Materials and Finishes Data

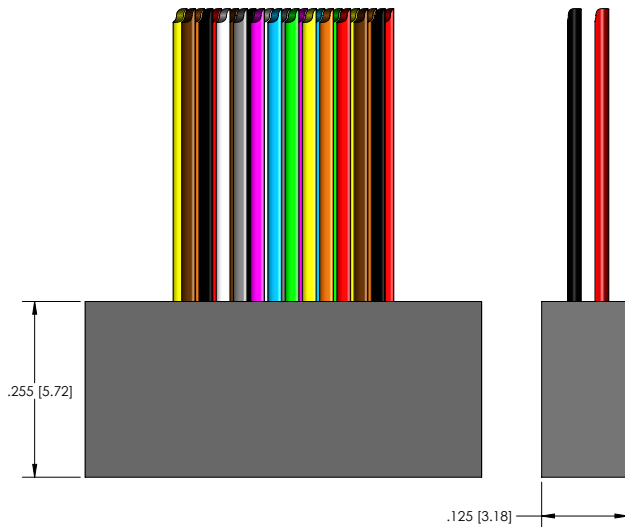

RECEPTACLE (SOCKETS)

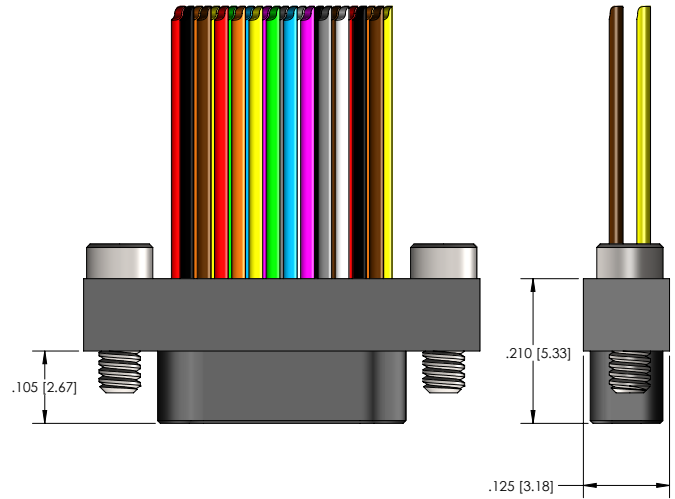

PLUG (PINS)

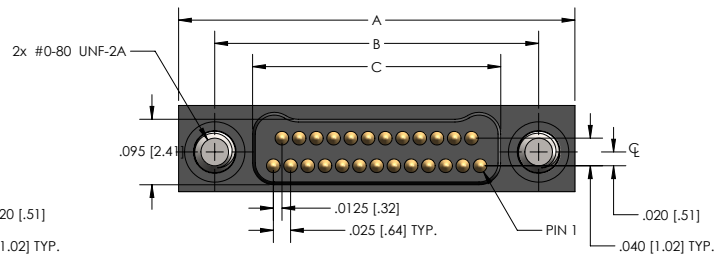
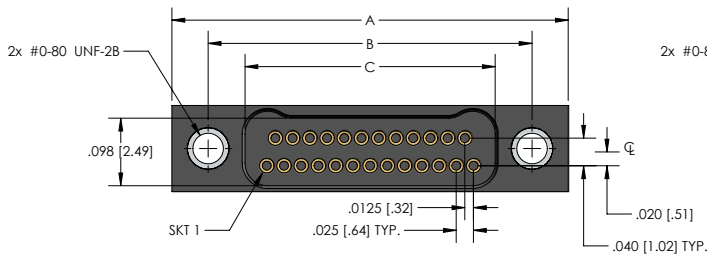

Size	P SERIES			
	A	B	Plug	C Receptacle
9	.375 [9.52]	.270 [6.86]	.160 [4.06]	.163 [4.14]
15	.450 [11.43]	.345 [8.76]	.235 [5.97]	.238 [6.04]
21	.525 [13.33]	.420 [10.67]	.310 [7.87]	.313 [7.95]
25	.575 [14.60]	.470 [11.94]	.360 [9.14]	.363 [9.22]
31	.650 [16.51]	.545 [13.84]	.435 [11.05]	.438 [11.12]
37	.725 [18.41]	.620 [15.75]	.510 [12.95]	.513 [13.03]
51	.900 [22.86]	.795 [20.19]	.685 [17.40]	.688 [17.47]
65	1.075 [27.30]	.970 [24.64]	.860 [21.84]	.863 [21.92]

WIRED CONNECTOR





















- Metal Shell Connector w/Wire Leads
- Operating Temperature -50° C to 200° C
- 9 to 65 Contacts



HOW TO ORDER

* Indicates preferred standard ** Consult factory for other plating options

N M L 25 - 2 P Ø2 /NMLX-2XX - 3Ø F 6 - 18.0 - SØ1

	Series	Insulator	Contacts	Insulator Type	Contact Gender	Hardware	Detail of Other End of the Harness	Wire Gauge	Wire Type	Color Code	Length	Finish**	Temp Range		
N= Nano	M= Metal	L= LCP	Ø9	2= Dual Row	P=Male/Pin (Plug Side)	Ø1=Phillips Head Jackscrew	Refer to the left columns for filling out the x	3Ø*	*F=Stranded, w/ Teflon insulation, per NEMA HP3-ET	1=White	*18.0	Blank= Cadmium	*blank = 125C		
			15					32	Y=Stranded w/ Tefzel insulation, per SAE AS22759/33	*6 = 10 solid colors, repeating	*36.0		HT = 200°C		
			21		S=Female/Socket (Receptacle Side)	Ø2=Allen Head Jackscrew		34	A=Stranded, per DSCC Ø4Ø47-3ØA (White, 3Ø AWG only)				*SØ1 = Nickel		
			25											SØ3 = Black Anodize	
			31			Ø5=Slotted Head Jackscrew								SØ6 = Olive-Drab Cadmium	
			37											SØ7 = Titanium	
			51			Ø6=Floating Phillips Head Jackscrew (Female Only)								SØ9 = Stainless	
			65												
						Ø7=Threaded Hole									
															
						Ø8=Floating Allen Head Jackscrew (Female Only)									
															
						Ø9=Floating Slotted Head Jackscrew (Female Only)									
															

MECHANICAL PERFORMANCE DATA	Go to Page 26 See chart 123 E or Click Here for Mechanical Performance Data
ELECTRICAL PERFORMANCE DATA	Go to Page 26 See chart 123 M or Click Here for Electrical Performance Data
MATERIALS DATA	Go to Page 26 See chart 123 M&F or Click Here for Materials and Finishes Data

NANO D - PID 127

DIMENSIONS

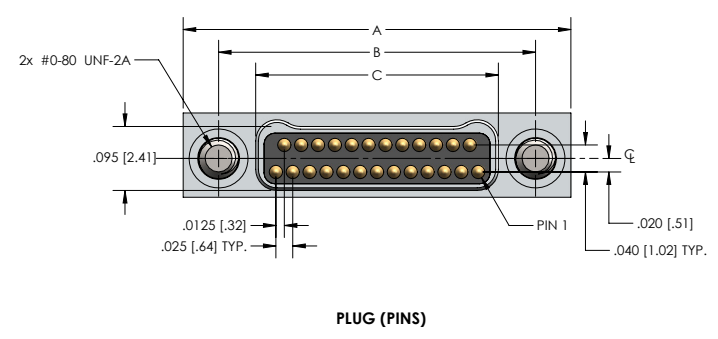
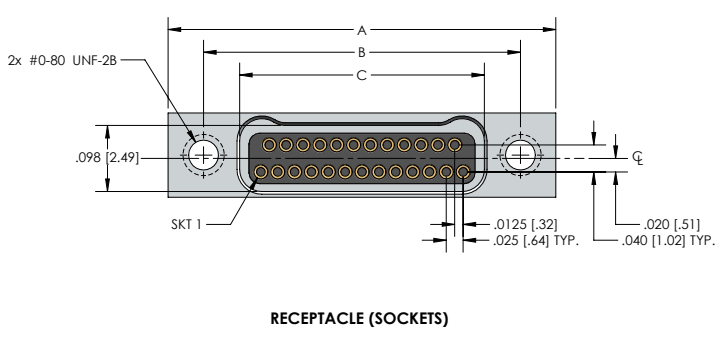
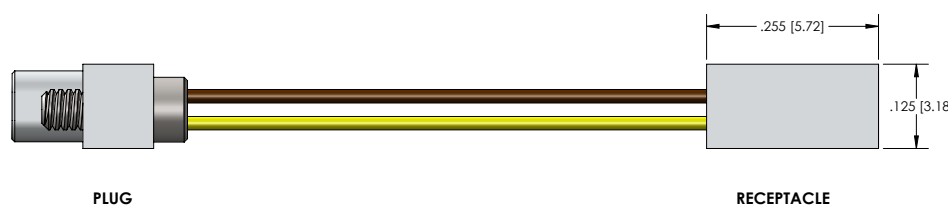
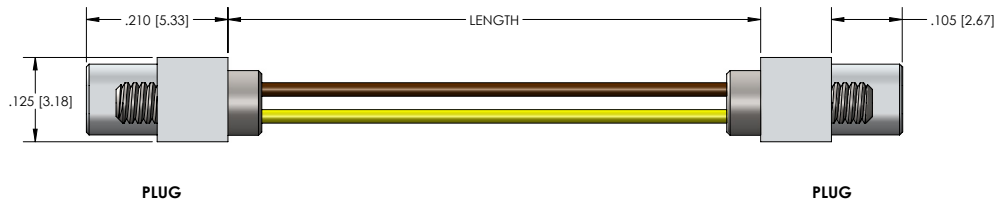

Size	M SERIES				
	A	B	Plug	C	Receptacle
9	.375 [9.52]	.270 [6.86]	.160 [4.06]		.163 [4.14]
15	.450 [11.43]	.345 [8.76]	.235 [5.97]		.238 [6.04]
21	.525 [13.33]	.420 [10.67]	.310 [7.87]		.313 [7.95]
25	.575 [14.60]	.470 [11.94]	.360 [9.14]		.363 [9.22]
31	.650 [16.51]	.545 [13.84]	.435 [11.05]		.438 [11.12]
37	.725 [18.41]	.620 [15.75]	.510 [12.95]		.513 [13.03]
51	.900 [22.86]	.795 [20.19]	.685 [17.40]		.688 [17.47]
65	1.075 [27.30]	.970 [24.64]	.860 [21.84]		.863 [21.92]

WIRED CONNECTOR









- Plastic Shell Connector w/Wire Leads
- Operating Temperature -50° C to 200° C
- 9 to 65 Contacts



HOW TO ORDER

* Indicates preferred standard

NANO D – PID 128

N	P	L	25	- 2	P	Ø2	/NPLX-2XX - 3Ø	F	6 -	18.Ø		
Series	Insulator	Contacts	Insulator Type	Contact Gender	Hardware	Detail of Other End of the Harness	Wire Gauge	Wire Type	Color Code	Length	Temp Range	
N = Nano	P = Plastic	L = LCP	Ø9	2 = Dual Row	P = Male/ Pin (Plug Side)	Ø1 = Phillips Head Jackscrew	Refer to the left columns for filling out the x	*F = Stranded, w/Teflon insulation, per NEMA HP3-ET	1 = White	*18.Ø	*blank = 125C	
		15				32		Y = Stranded w/Tefzel insulation, per SAE AS22759/33	*6 = 10 solid colors, repeating	*36.Ø	HT = 200°C	
		21		S = Female/ Socket (Receptacle Side)	Ø2 = Allen Head Jackscrew		34	A = Stranded, per DSCC Ø4Ø47-3ØA (White, 3Ø AWG only)				
		25										
		31			Ø5 = Slotted Head Jackscrew							
		37										
		51			Ø6 = Floating Phillips Head Jackscrew (Female Only)							
		65										
					Ø7 = Threaded Hole							
												
					Ø8 = Floating Allen Head Jackscrew (Female Only)							
												
					Ø9 = Floating Slotted Head Jackscrew (Female Only)							
												

MECHANICAL PERFORMANCE DATA	Go to Page 26 See chart 123 M or Click Here for Mechanical Performance Data
ELECTRICAL PERFORMANCE DATA	Go to Page 26 See chart 123 E or Click Here for Electrical Performance Data
MATERIALS DATA	Go to Page 26 See chart 126 M&F or Click Here for Materials and Finishes Data

DIMENSIONS

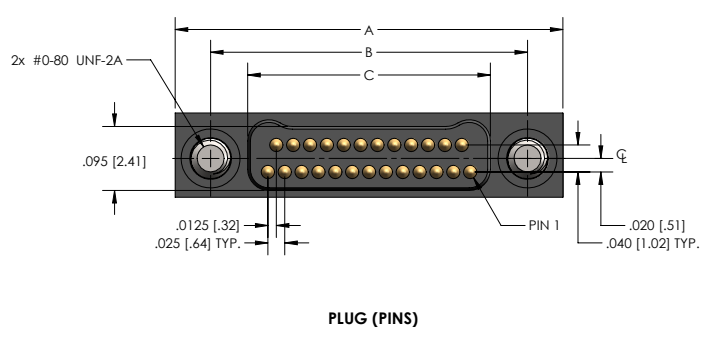
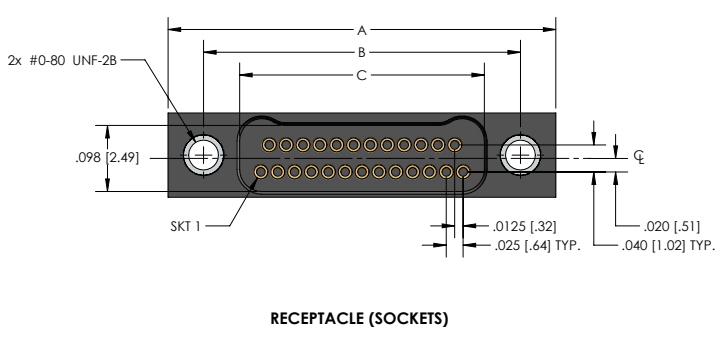
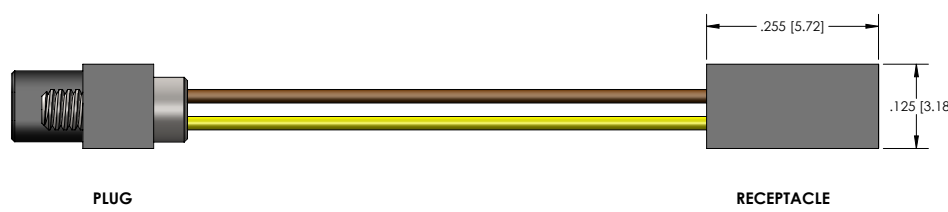
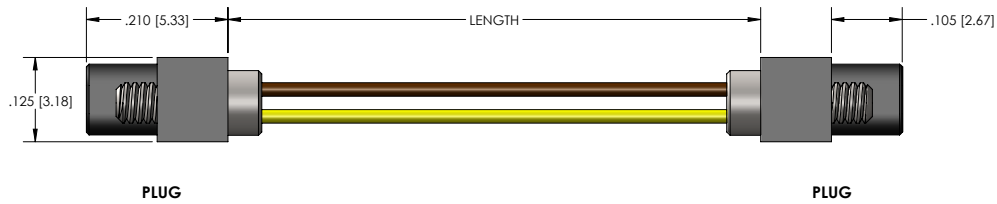

Size	NP SERIES				
	A	B	Plug	C	Receptacle
9	.375 [9.52]	.270 [6.86]	.160 [4.06]		.163 [4.14]
15	.450 [11.43]	.345 [8.76]	.235 [5.97]		.238 [6.04]
21	.525 [13.33]	.420 [10.67]	.310 [7.87]		.313 [7.95]
25	.575 [14.60]	.470 [11.94]	.360 [9.14]		.363 [9.22]
31	.650 [16.51]	.545 [13.84]	.435 [11.05]		.438 [11.12]
37	.725 [18.41]	.620 [15.75]	.510 [12.95]		.513 [13.03]
51	.900 [22.86]	.795 [20.19]	.685 [17.40]		.688 [17.47]
65	1.075 [27.30]	.970 [24.64]	.860 [21.84]		.863 [21.92]





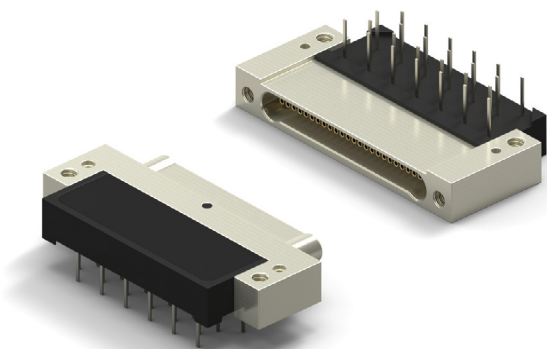







CIRCUIT CONNECTOR RIGHT ANGLE

- Metal Shell Connector
- Plated Thru Hole .050 x .050 (Style 8)
- 1 Piece Contact
- Flat Tail Termination
- Operating Temperature -50° C to 200° C
- 9 to 51 Contacts



HOW TO ORDER

* Indicates preferred standard ** Consult factory for other plating options

CN	M	8	L	25	-1	P	Ø7	1	-SØ1	Temp Range	Mounting Option
Series	Style	Insulator	Contacts	Insulator Type	Contact Gender	Hardware	Color Code	Finish**			
CN=Nano	M= Metal Shell	Style=8	L=LCP	Ø9	1= Single Row	P=Male/Pin (Plug Side)	Ø7=Threaded Hole	1= Tin plated (6Ø/4Ø)	Blank= Cadmium	*blank = 125C	*Blank=Threaded Mounting Holes
				15				2=Gold plated (RoHS)		HT = 200°C	
				21		S=Female/Socket (Receptacle Side)"			*SØ1= Nickel		1=Solder Alignment Posts with Threaded Mounting Holes
				25							
				31					SØ3 = Black Anodize		2= Clearance Mounting Holes
				37							
				51					SØ6 = Olive-Drab Cadmium		3=Solder Alignment Posts with Clearance Mounting Holes
											
									SØ7 =Titanium		
											
									SØ9=Stainless		
											

ELECTRICAL PERFORMANCE DATA	Go to Page 26 See chart 133 E or Click Here for Electrical Performance Data
MECHANICAL PERFORMANCE DATA	Go to Page 26 See chart 123 M or Click Here for Mechanical Performance Data
MATERIALS DATA	Go to Page 26 See chart 131 M&F or Click Here for Materials and Finishes Data

DIMENSIONS

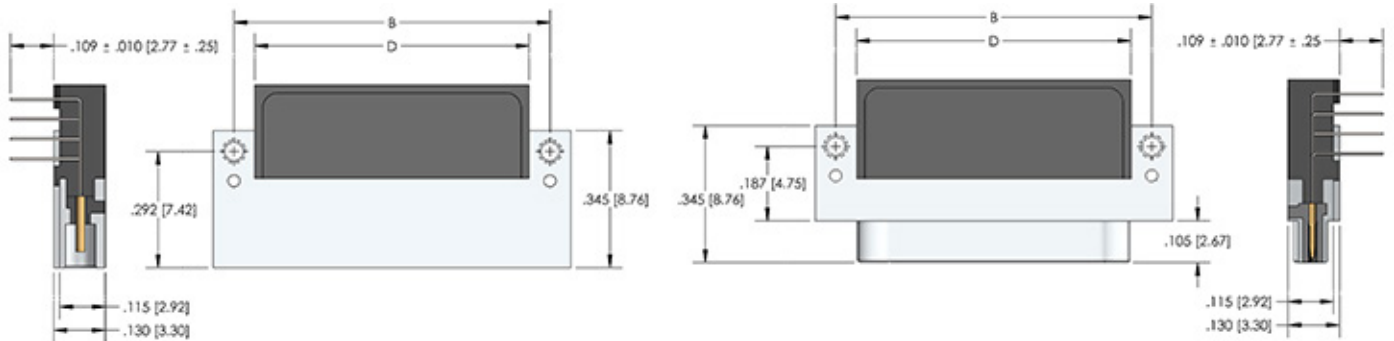

RECEPTACLE (SOCKETS)

PLUG (PINS)

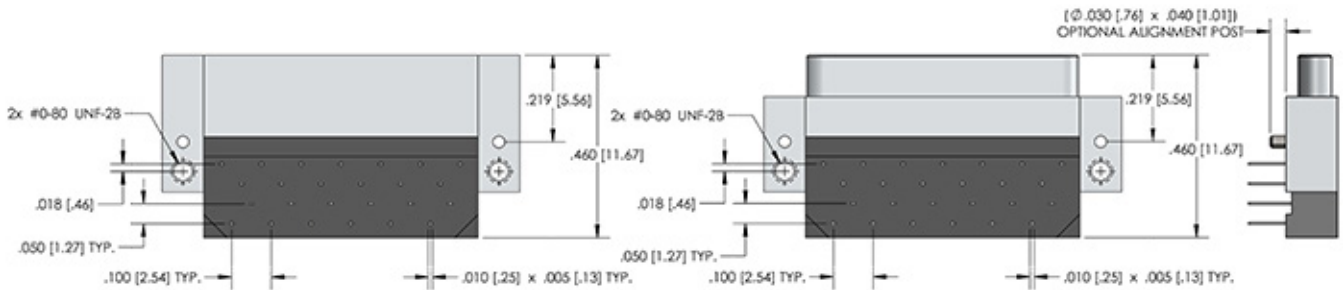
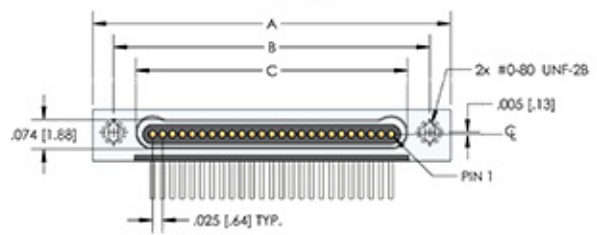
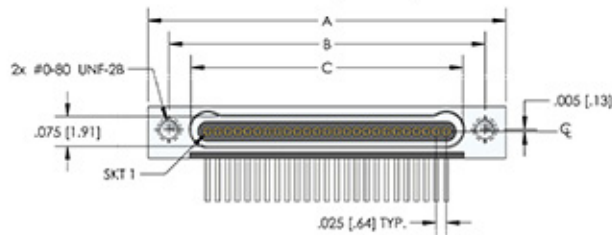

Size	CNM SERIES				
	A	B	Plug C	Receptacle	D
9	.500 [12.70]	.395 [10.03]	.284 [7.21]	.285 [7.24]	.300 [7.62]
15	.650 [16.51]	.545 [13.84]	.434 [11.02]	.435 [11.05]	.450 [11.43]
21	.800 [20.32]	.695 [17.65]	.584 [14.83]	.585 [14.86]	.600 [15.24]
25	.900 [22.86]	.795 [20.19]	.684 [17.37]	.685 [17.40]	.700 [17.78]
31	1.050 [26.67]	.945 [24.00]	.834 [21.18]	.835 [21.21]	.850 [21.59]
37	1.200 [30.48]	1.095 [27.81]	.984 [24.99]	.985 [25.02]	1.000 [25.40]
51	1.550 [39.37]	1.445 [36.70]	1.334 [33.88]	1.335 [33.91]	1.350 [34.29]

CIRCUIT CONNECTOR RIGHT ANGLE

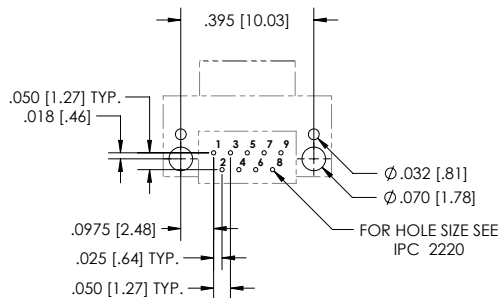
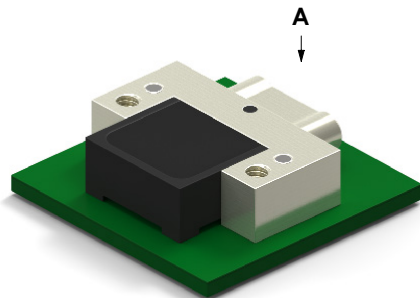

SIZE 9 - VIEW A

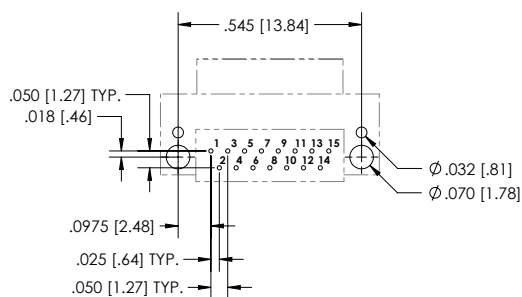

SIZE 15 - VIEW A

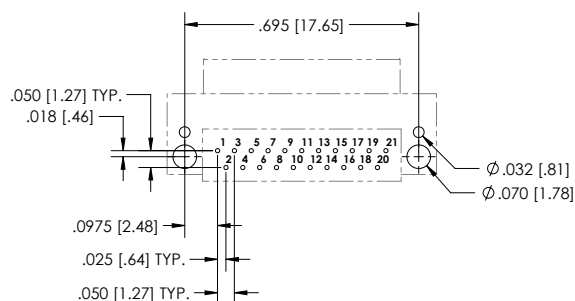

SIZE 21 - VIEW A

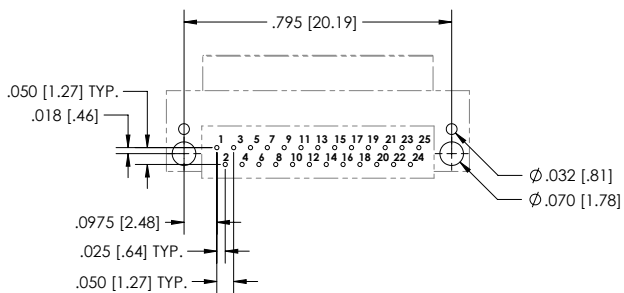

SIZE 25 - VIEW A

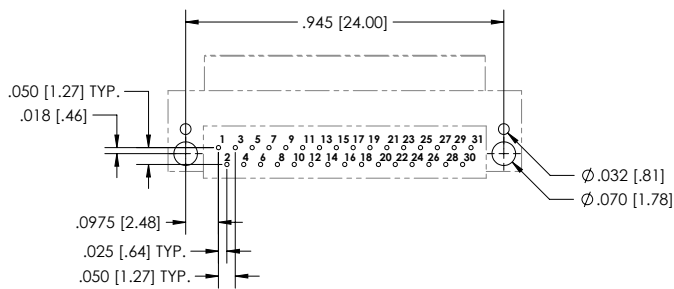

SIZE 31 - VIEW A

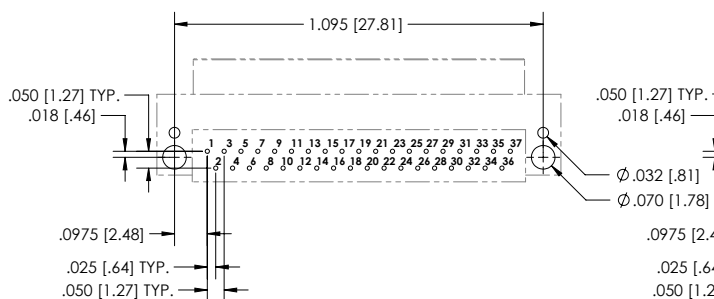

SIZE 37 - VIEW A

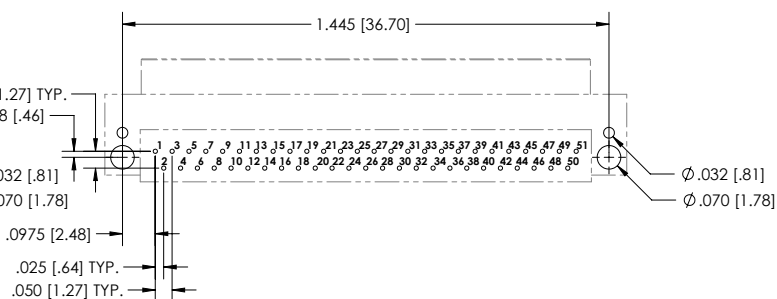

SIZE 51 - VIEW A

CIRCUIT CONNECTOR RIGHT ANGLE

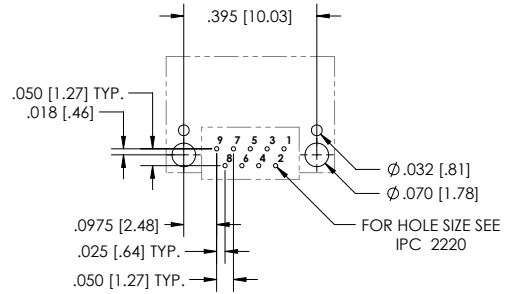
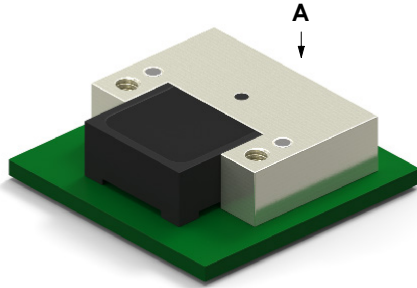

SIZE 9 - VIEW A

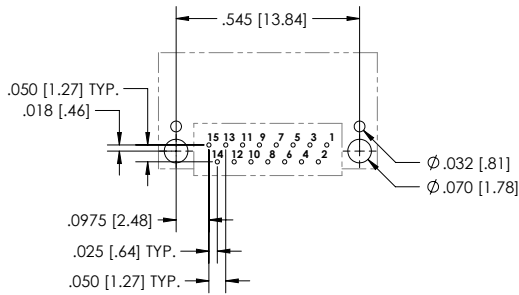

SIZE 15 - VIEW A

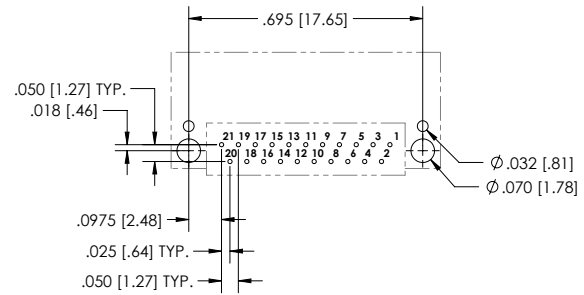

SIZE 21 - VIEW A

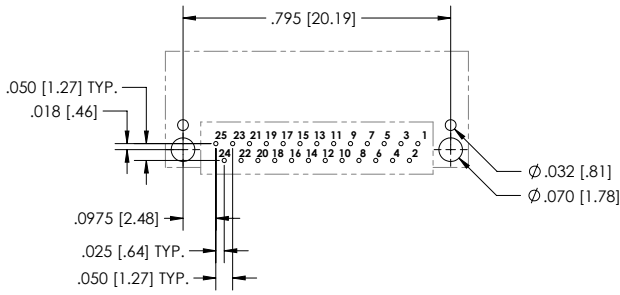

SIZE 25 - VIEW A

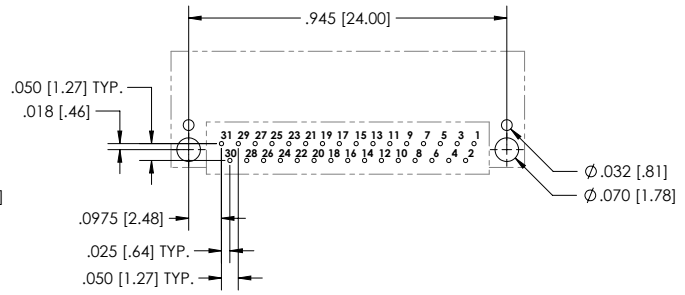

SIZE 31 - VIEW A

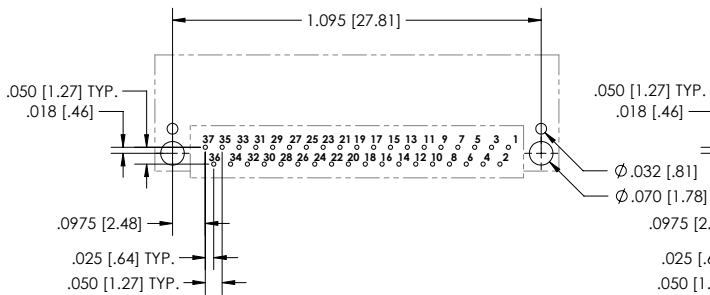

SIZE 37 - VIEW A

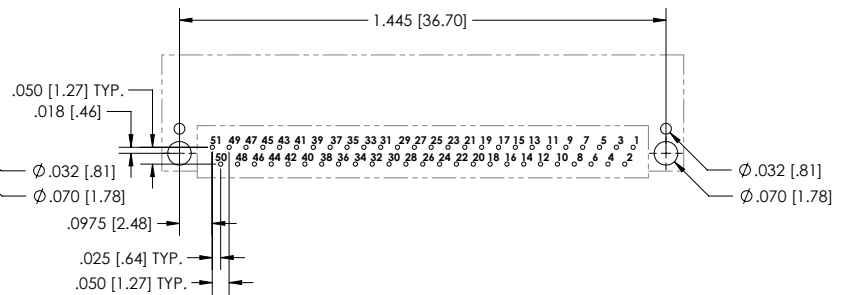

SIZE 51 - VIEW A

CIRCUIT CONNECTOR RIGHT ANGLE



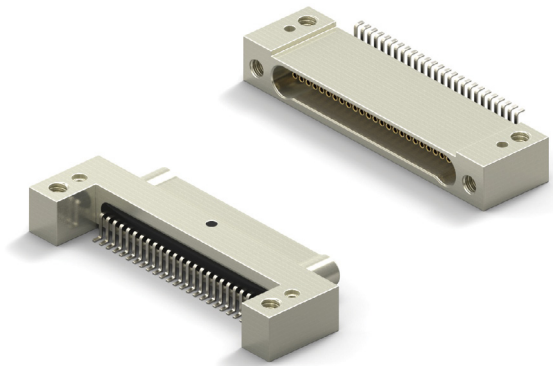









- Metal Shell Connector
- Surface Mount .025 (Style 28)
- 1 Piece Contact
- Flat Tail Termination
- Operating Temperature -50° C to 200° C
- 9 to 51 Contacts



NANO D – PID 132

HOW TO ORDER

* Indicates preferred standard ** Consult factory for other plating options

CN	M	28	L	25	-1	P	Ø7	1	-SØ1		
Series	Style	Insulator	Contacts	Insulator Type	Contact Gender	Hardware	Color Code	Finish**	Temp Range	Mounting Option	
CN=Nano	M= Metal Shell	Style=28	L=LCP	Ø9	1= Single Row	P=Male/Pin (Plug Side)	Ø7=Threaded Hole	1= Tin plated (6Ø/4Ø)	Blank= Cadmium	*blank = 125C	*Blank=Threaded Mounting Holes
			15					2=Gold plated (RoHS)		HT = 200°C	
			21			S=Female/Socket (Receptacle Side)			*SØ1= Nickel		1=Solder Alignment Posts with Threaded Mounting Holes
			25								
			31						SØ3 = Black Anodize		2= Clearance Mounting Holes
			37								
			51						SØ6 = Olive-Drab Cadmium		3=Solder Alignment Posts with Clearance Mounting Holes
											
									SØ7 =Titanium		
											
									SØ9=Stainless		
											

ELECTRICAL PERFORMANCE DATA	Go to Page 26 See chart 133 E or Click Here for Electrical Performance Data
MECHANICAL PERFORMANCE DATA	Go to Page 26 See chart 123 M or Click Here for Mechanical Performance Data
MATERIALS DATA	Go to Page 26 See chart 131 M&F or Click Here for Materials and Finishes Data

DIMENSIONS

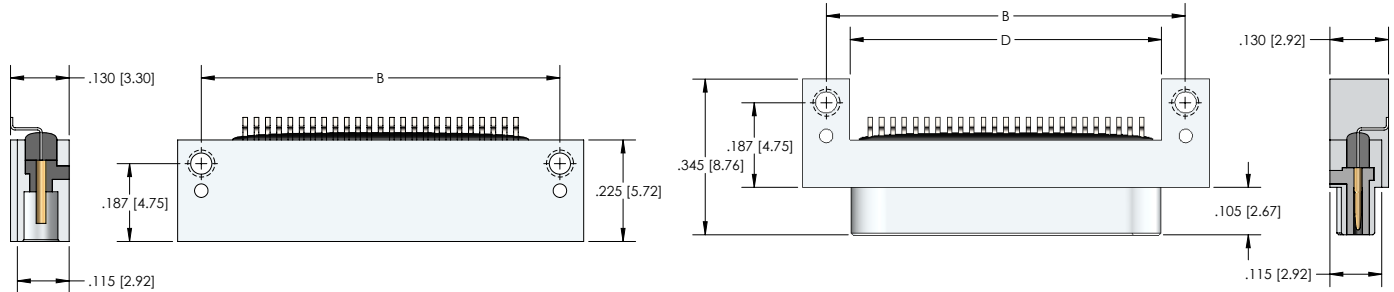

RECEPTACLE (SOCKETS)

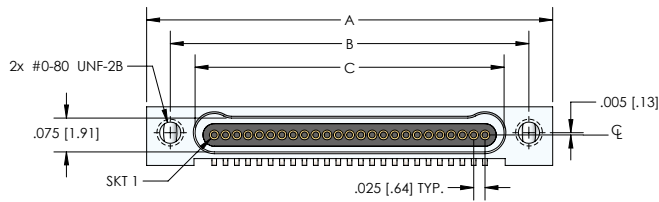

PLUG (PINS)

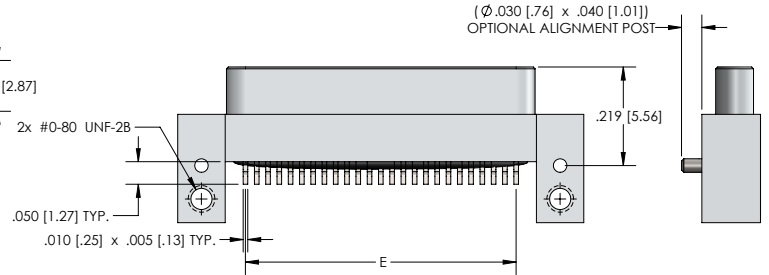
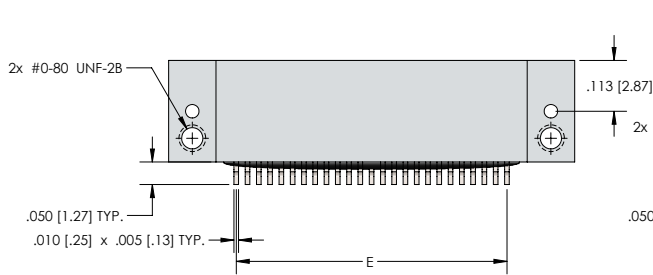
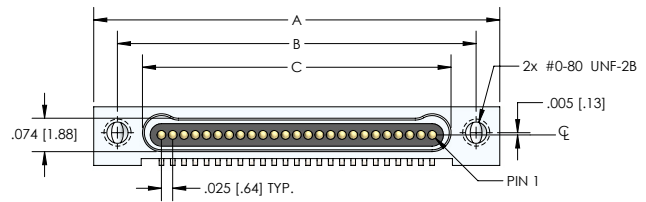

Size	CNM SERIES				
	A	B	Plug C	Receptacle	D
9	.500 [12.70]	.395 [10.03]	.284 [7.21]	.285 [7.24]	.300 [7.62]
15	.650 [16.51]	.545 [13.84]	.434 [11.02]	.435 [11.05]	.450 [11.43]
21	.800 [20.32]	.695 [17.65]	.584 [14.83]	.585 [14.86]	.600 [15.24]
25	.900 [22.86]	.795 [20.19]	.684 [17.37]	.685 [17.40]	.700 [17.78]
31	1.050 [26.67]	.945 [24.00]	.834 [21.18]	.835 [21.21]	.850 [21.59]
37	1.200 [30.48]	1.095 [27.81]	.984 [24.99]	.985 [25.02]	1.000 [25.40]
51	1.550 [39.37]	1.445 [36.70]	1.334 [33.88]	1.335 [33.91]	1.350 [34.29]

CIRCUIT CONNECTOR RIGHT ANGLE

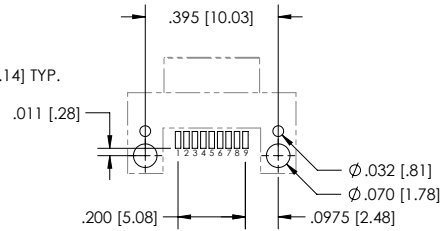
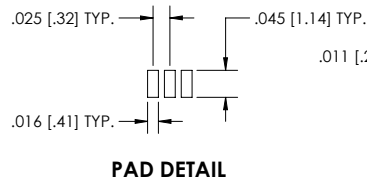
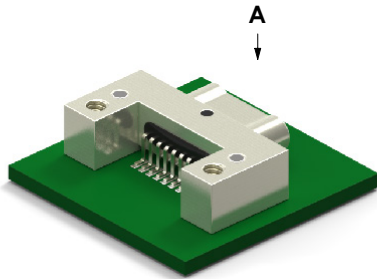

SIZE 9 - VIEW A

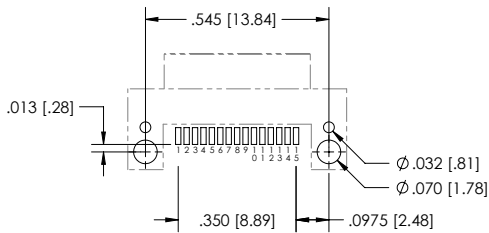

SIZE 15 - VIEW A

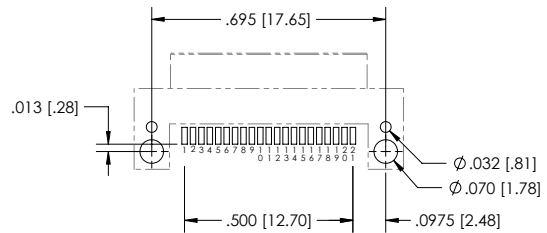

SIZE 21 - VIEW A

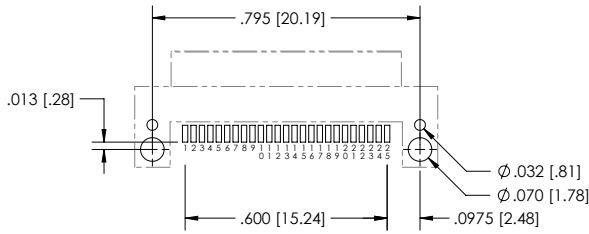

SIZE 25 - VIEW A

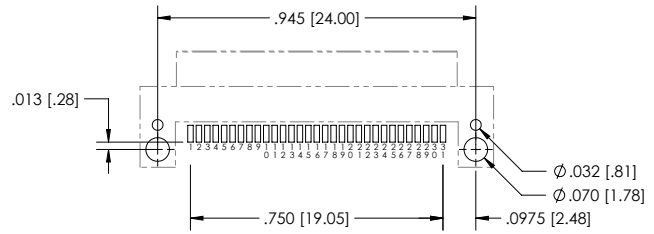

SIZE 31 - VIEW A

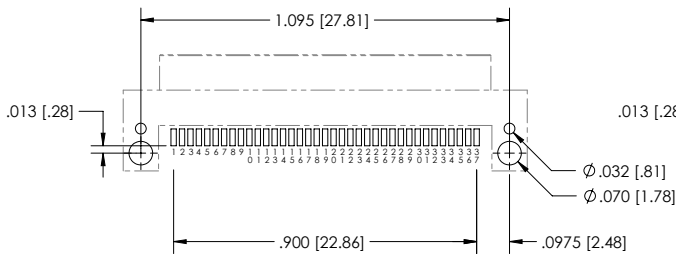

SIZE 37 - VIEW A

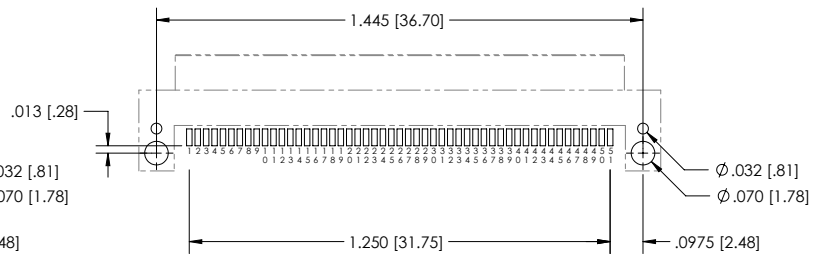

SIZE 51 - VIEW A

CIRCUIT CONNECTOR RIGHT ANGLE

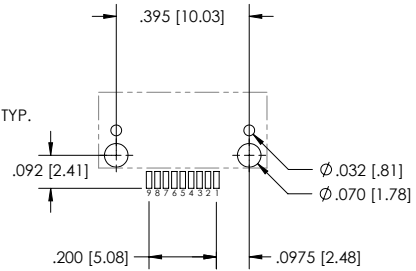
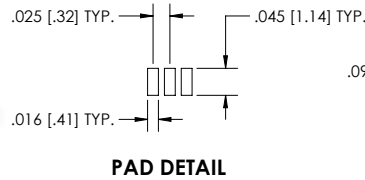
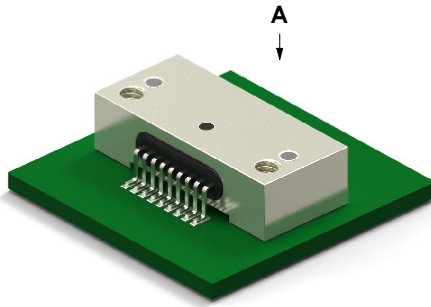

SIZE 9 - VIEW A

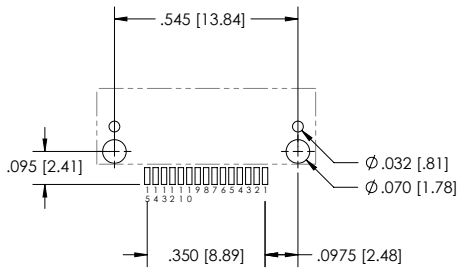

SIZE 15 - VIEW A

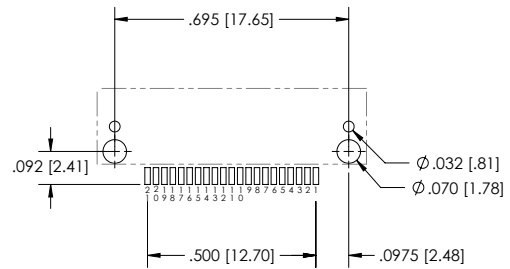

SIZE 21 - VIEW A

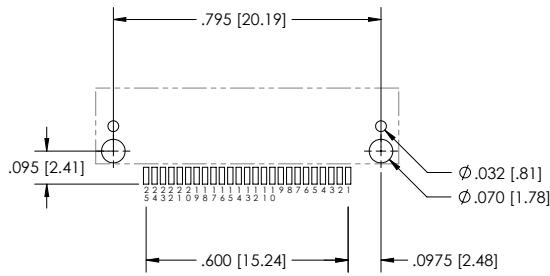

SIZE 25 - VIEW A

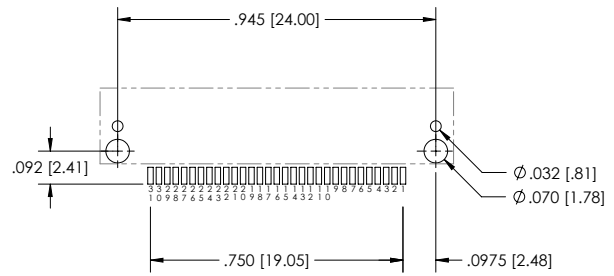

SIZE 31 - VIEW A

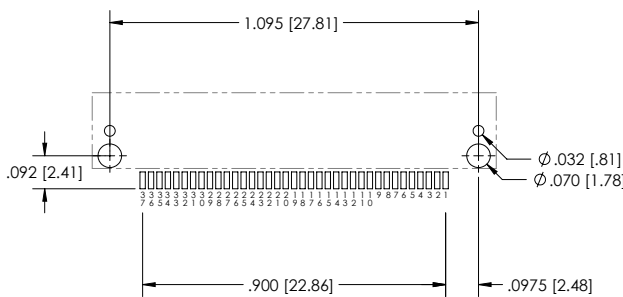

SIZE 37 - VIEW A

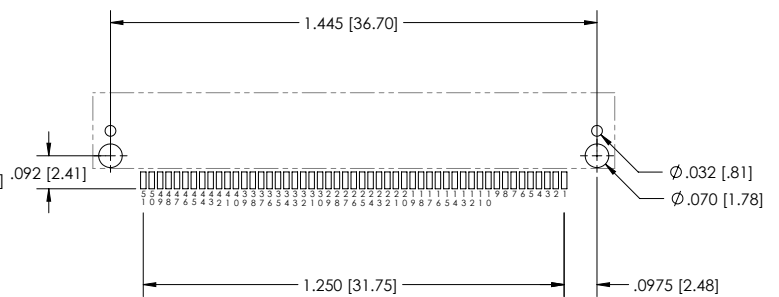

SIZE 51 - VIEW A

CIRCUIT CONNECTOR RIGHT ANGLE

- Metal Shell Connector
- Plated Thru Hole .050 x .050 (Style 8)
- 1 Piece Contact
- Flat Tail Termination
- Operating Temperature -50° C to 200° C
- 9 to 65 Contacts

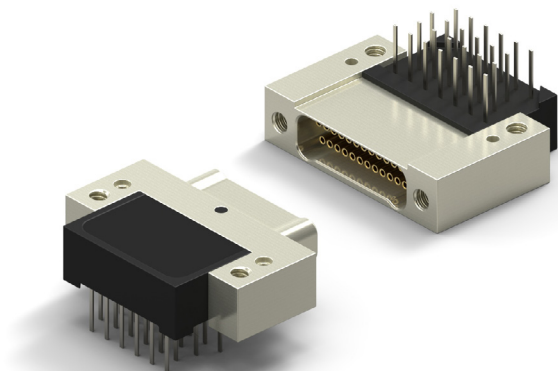













NANO D – PID 133

HOW TO ORDER

* Indicates preferred standard ** Consult factory for other plating options

CN M 8 L 25 - 2 P Ø7 1 - SØ1

CN	Series	Style	Insulator	Contacts	Insulator Type	Contact Gender	Hardware	Color Code	Finish**	Temp Range	Mounting Option
CN=Nano	M= Metal Shell	Style=8	L=LCP	Ø9	2= Single Row	P=Male/Pin (Plug Side)	Ø7=Threaded Hole	1= Tin plated (6Ø/4Ø)	Blank= Cadmium	*blank = 125C	*Blank=Threaded Mounting Holes
				15				2= Gold plated (RoHS)		HT = 200°C	
				21		S=Female/Socket (Receptacle Side)			*SØ1= Nickel		1=Solder Alignment Posts with Threaded Mounting Holes
				25							
				31					SØ3 = Black Anodize		2= Clearance Mounting Holes
				37							
				51					SØ6 = Olive-Drab Cadmium		3=Solder Alignment Posts with Clearance Mounting Holes
				65							
									SØ7 =Titanium		
											
									SØ9=Stainless		
											

ELECTRICAL PERFORMANCE DATA	Go to Page 26 See chart 133 E or Click Here for Electrical Performance Data
MECHANICAL PERFORMANCE DATA	Go to Page 26 See chart 123 M or Click Here for Mechanical Performance Data
MATERIALS DATA	Go to Page 26 See chart 131 M&F or Click Here for Materials and Finishes Data

DIMENSIONS

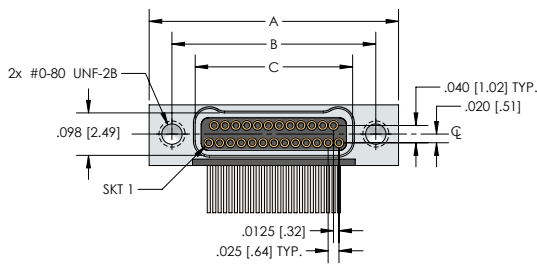
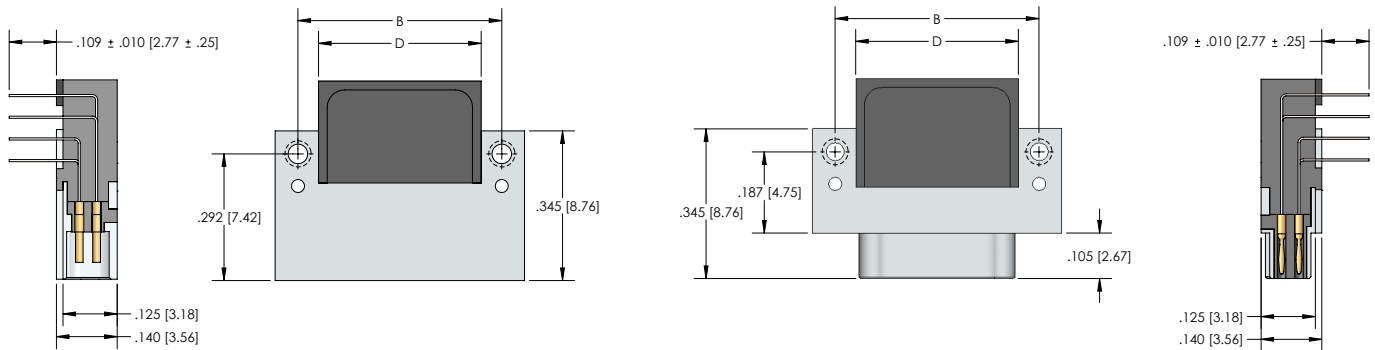

RECEPTACLE (SOCKETS)

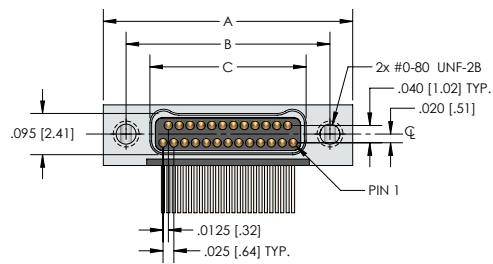

PLUG (PINS)

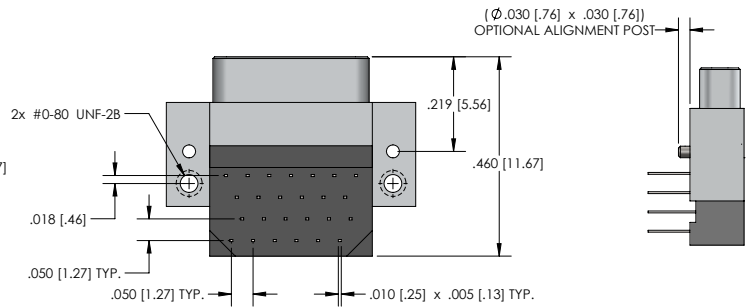
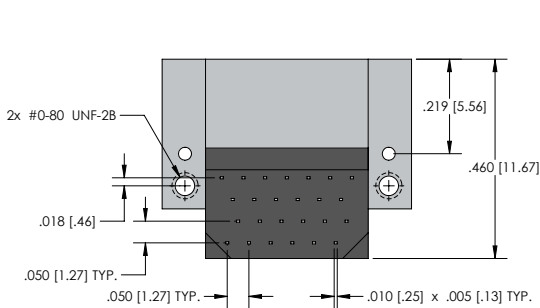

Size	CNM SERIES				
	A	B	Plug C	Receptacle	D
9	.375 [9.52]	.270 [6.86]	.160 [4.06]	.163 [4.14]	.175 [4.44]
15	.450 [11.43]	.345 [8.76]	.235 [5.97]	.238 [6.04]	.250 [6.35]
21	.525 [13.33]	.420 [10.67]	.310 [7.87]	.313 [7.95]	.325 [8.25]
25	.575 [14.60]	.470 [11.94]	.360 [9.14]	.363 [9.22]	.375 [9.52]
31	.650 [16.51]	.545 [13.84]	.435 [11.05]	.438 [11.12]	.450 [11.43]
37	.725 [18.41]	.620 [15.75]	.510 [12.95]	.513 [13.03]	.525 [13.33]
51	.900 [22.86]	.795 [20.19]	.685 [17.40]	.688 [17.47]	.700 [17.78]
65	1.075 [27.30]	.970 [24.64]	.860 [21.84]	.863 [21.92]	.875 [22.22]

CIRCUIT CONNECTOR RIGHT ANGLE PCB LAYOUT

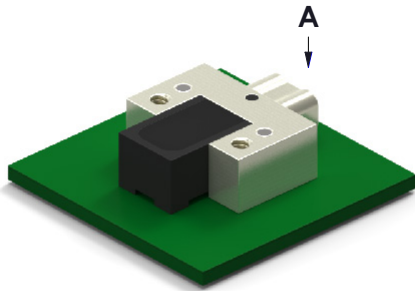

NANO D – PID 133

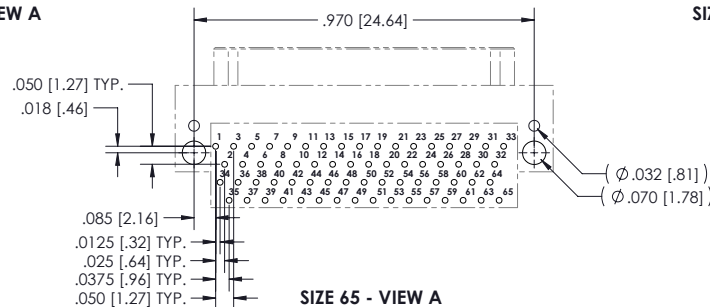
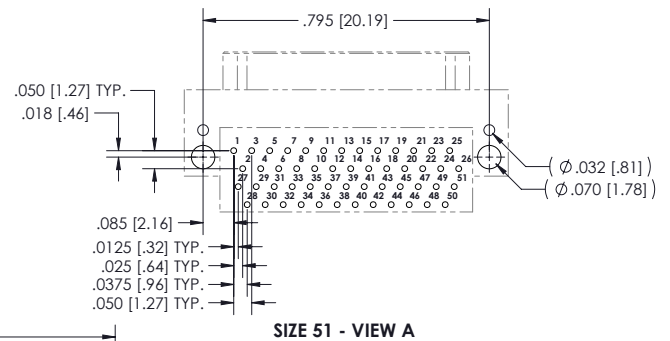
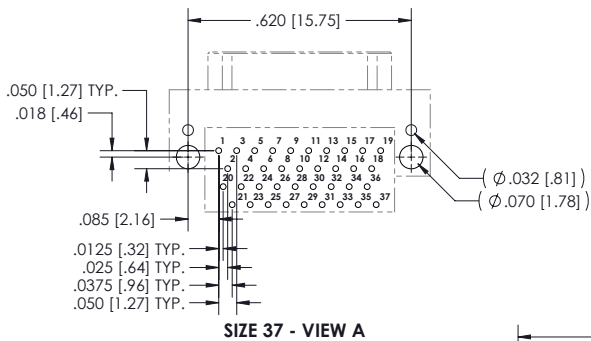
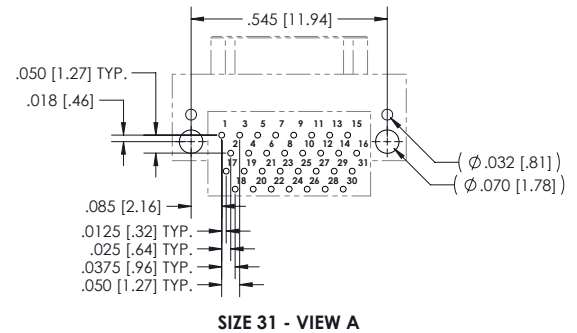
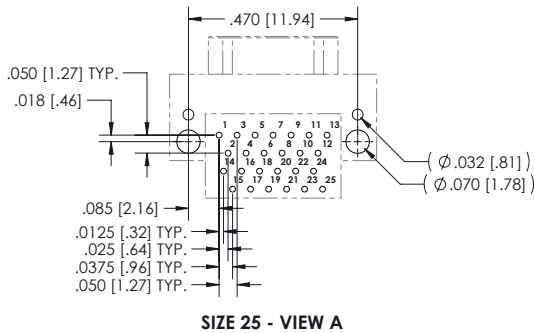
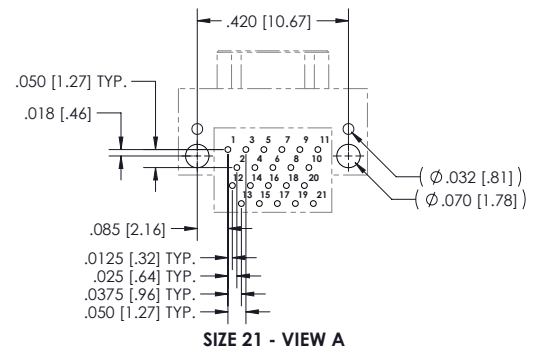
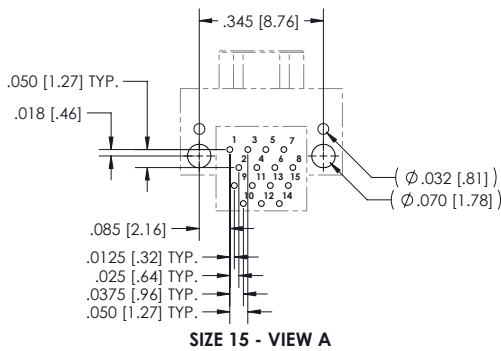
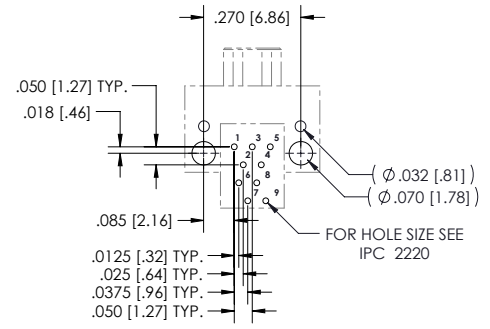

CIRCUIT CONNECTOR RIGHT ANGLE PCB LAYOUT

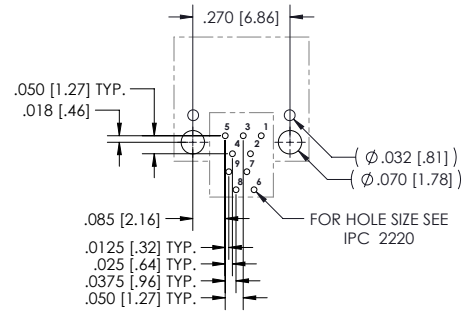
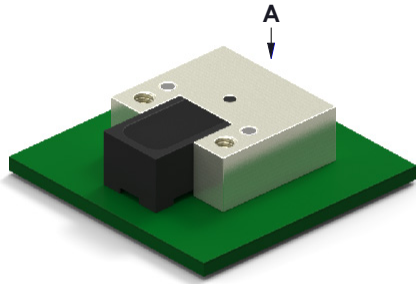

SIZE 9 - VIEW A

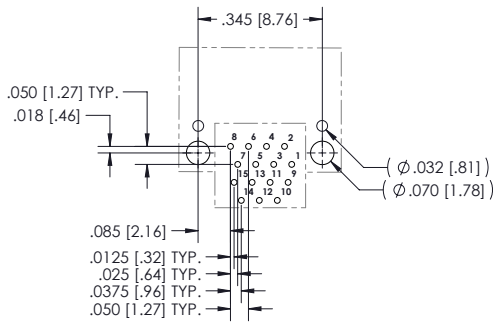

SIZE 15 - VIEW A

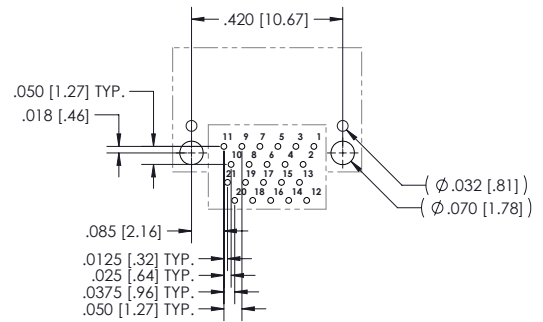

SIZE 21 - VIEW A

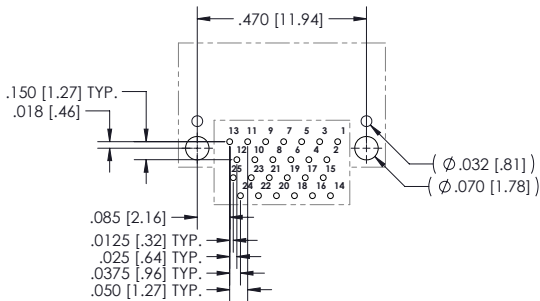

SIZE 25 - VIEW A

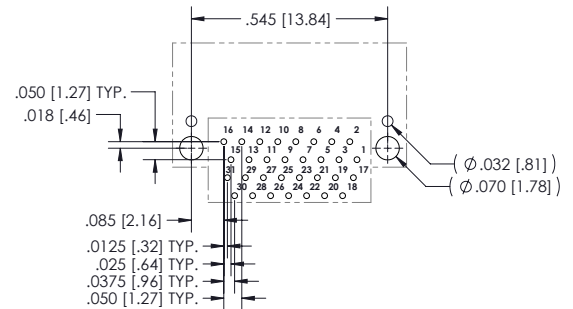

SIZE 31 - VIEW A

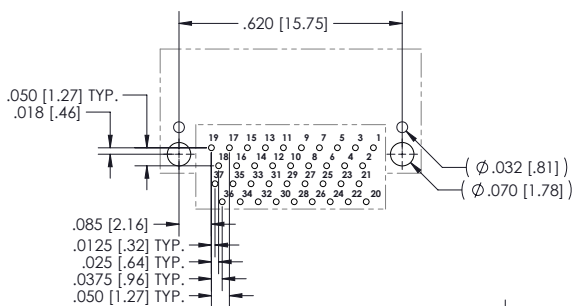

SIZE 37 - VIEW A

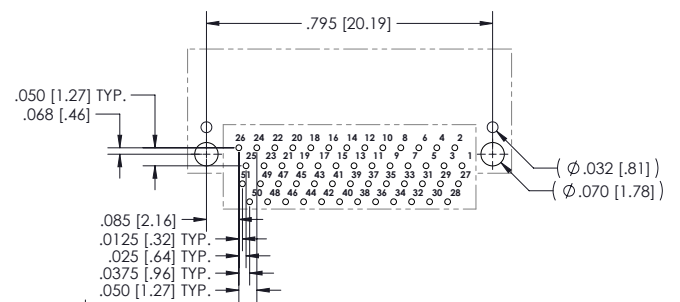

SIZE 51 - VIEW A

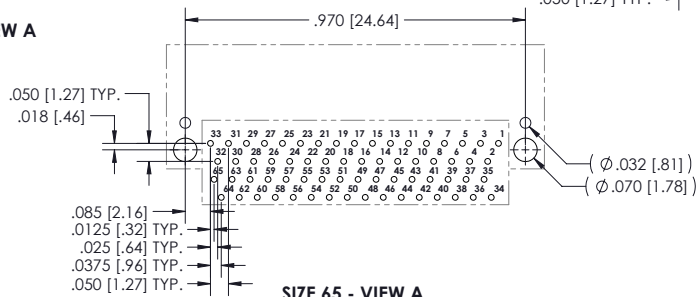

SIZE 65 - VIEW A

CIRCUIT CONNECTOR RIGHT ANGLE



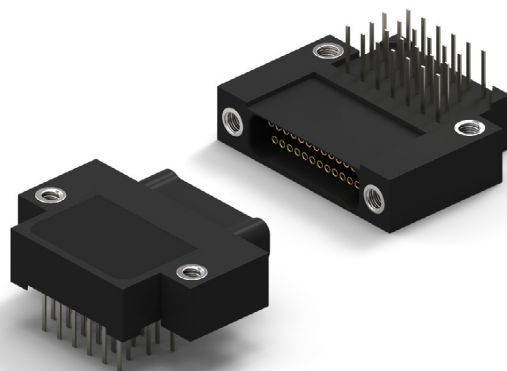

- Plastic Shell Connector
- Plated Thru Hole .050 x .050 (Style 8)
- 1 Piece Contact
- Flat Tail Termination
- Operating Temperature -50° C to 200° C
- 9 to 65 Contacts



NANO D – PID 134

HOW TO ORDER

* Indicates preferred standard

CN	P	8	L	25	- 2	P	Ø7	1		
Series	Style	Insulator	Contacts	Insulator Type	Contact Gender	Hardware	Color Code	Temp Range	Mounting Option	
CN=Nano	P=Plastic Shell	Style=8	L=LCP	Ø9	2= Dual Row	P=Male/Pin (Plug Side)	Ø7=Threaded Hole	1= Tin plated (6Ø/4Ø)	*blank = 125C	*Blank=Threaded Mounting Holes
				15				2= Gold plated (RoHS)	HT = 200°C	
				21		S=Female/Socket (Receptacle Side)				
				25						
				31						
				37						
				51						
				65						

ELECTRICAL PERFORMANCE DATA	Go to Page 26 See chart 133 E or Click Here for Electrical Performance Data
MECHANICAL PERFORMANCE DATA	Go to Page 26 See chart 123 M or Click Here for Mechanical Performance Data
MATERIALS DATA	Go to Page 26 See chart 126 M&F or Click Here for Materials and Finishes Data

DIMENSIONS

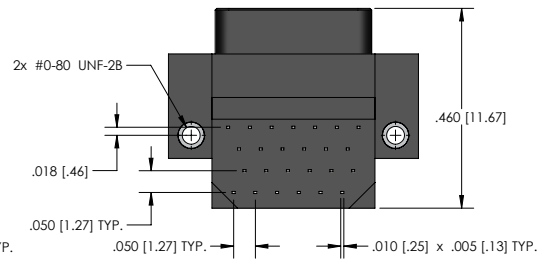
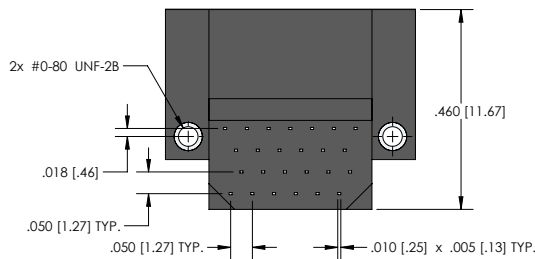
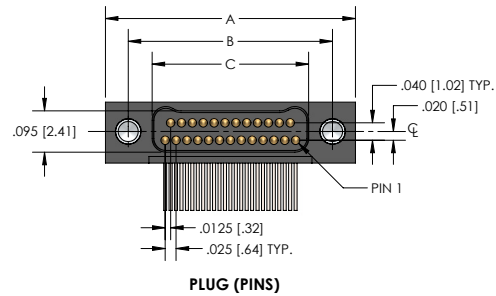
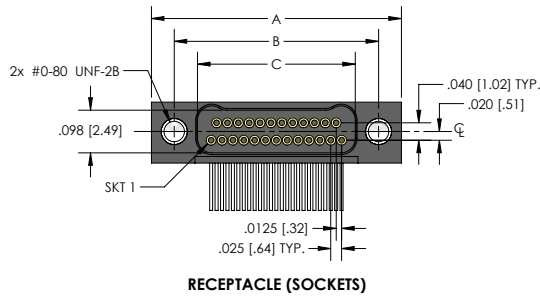
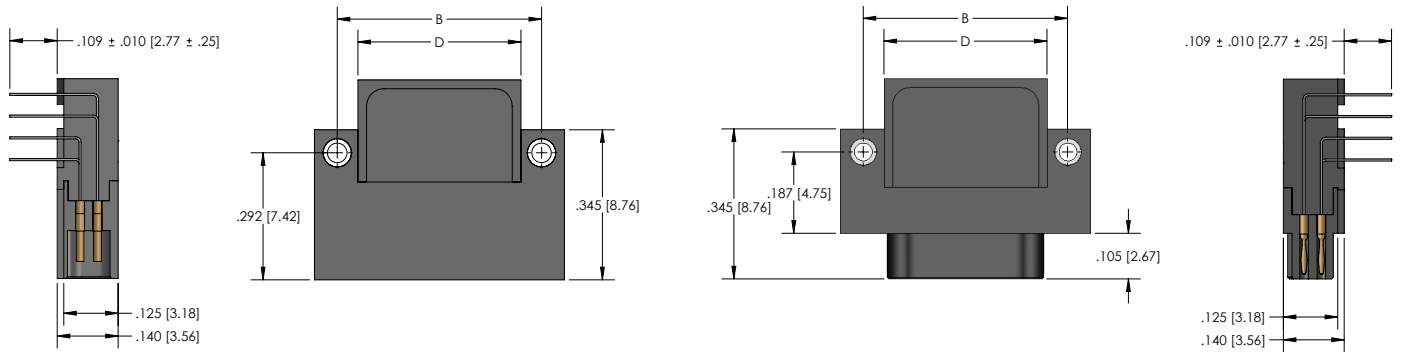

Size	CNP SERIES				
	A	B	Plug C	Receptacle	D
9	.375 [9.52]	.270 [6.86]	.160 [4.06]	.163 [4.14]	.175 [4.44]
15	.450 [11.43]	.345 [8.76]	.235 [5.97]	.238 [6.04]	.250 [6.35]
21	.525 [13.33]	.420 [10.67]	.310 [7.87]	.313 [7.95]	.325 [8.25]
25	.575 [14.60]	.470 [11.94]	.360 [9.14]	.363 [9.22]	.375 [9.52]
31	.650 [16.51]	.545 [13.84]	.435 [11.05]	.438 [11.12]	.450 [11.43]
37	.725 [18.41]	.620 [15.75]	.510 [12.95]	.513 [13.03]	.525 [13.33]
51	.900 [22.86]	.795 [20.19]	.685 [17.40]	.688 [17.47]	.700 [17.78]
65	1.075 [27.30]	.970 [24.64]	.860 [21.84]	.863 [21.92]	.875 [22.22]

CIRCUIT CONNECTOR RIGHT ANGLE PCB LAYOUT

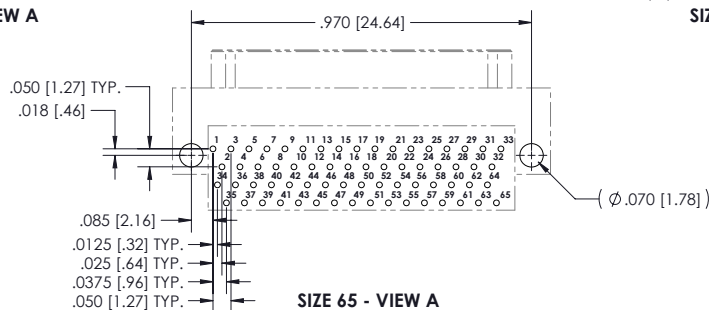
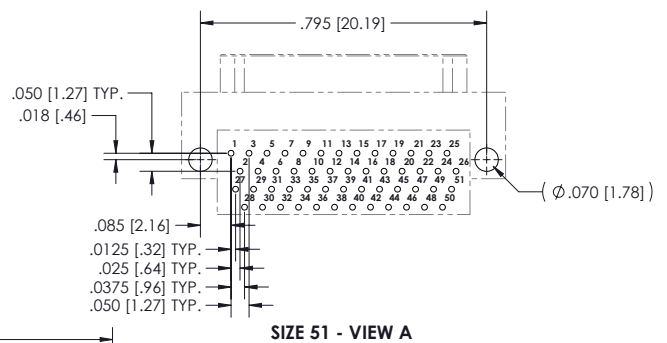
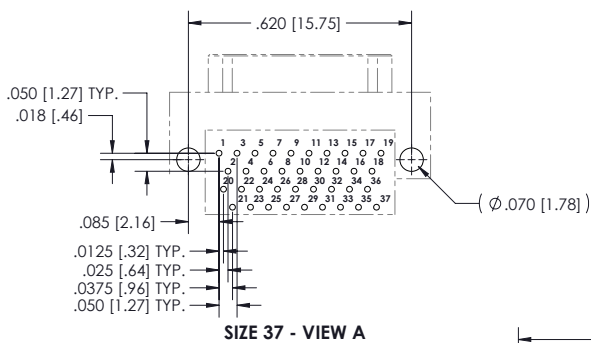
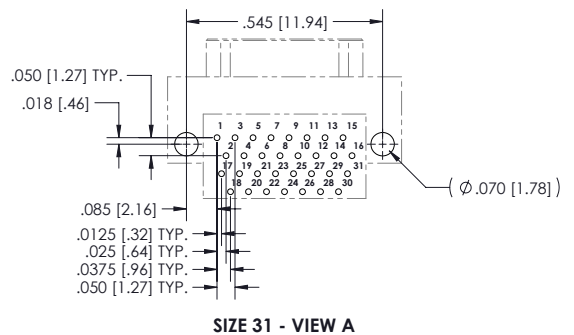
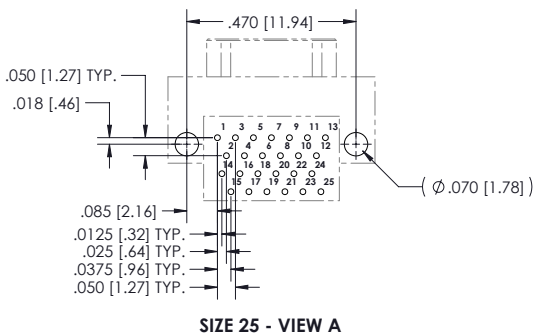
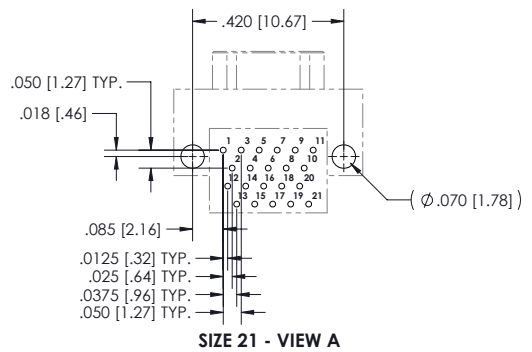
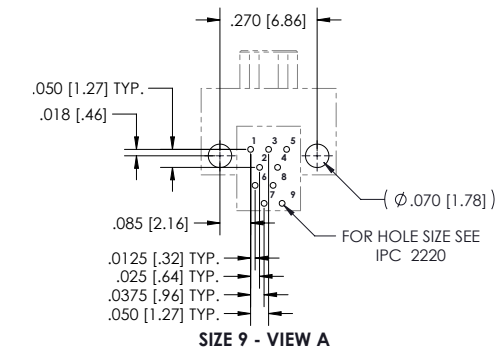
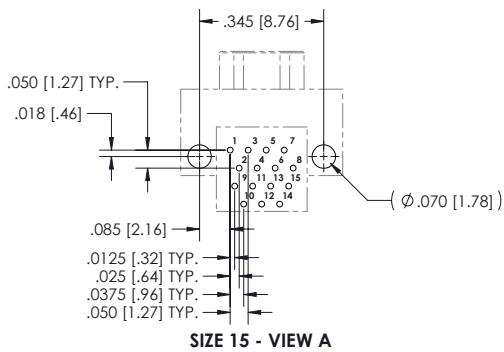
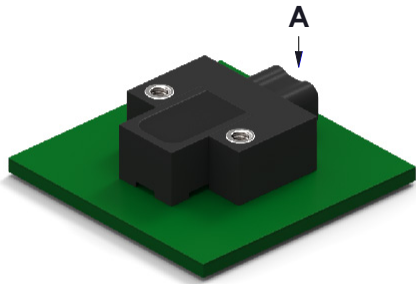

CIRCUIT CONNECTOR RIGHT ANGLE PCB LAYOUT

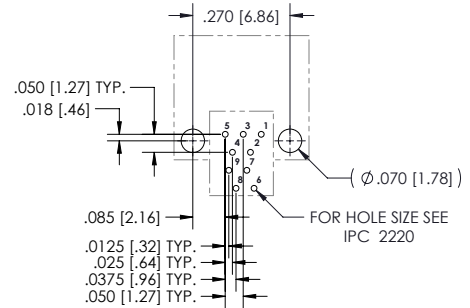
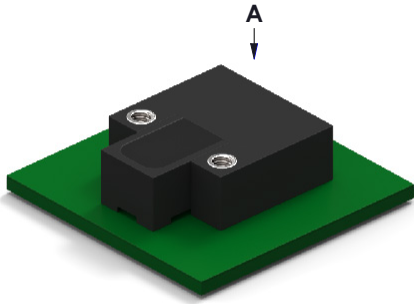

SIZE 9 - VIEW A

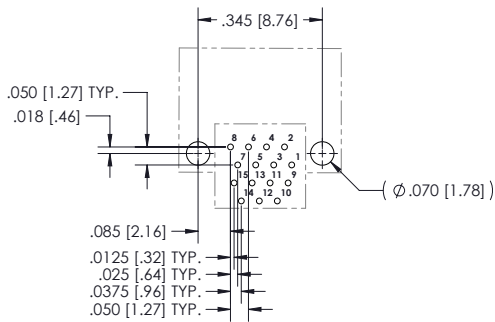

SIZE 15 - VIEW A

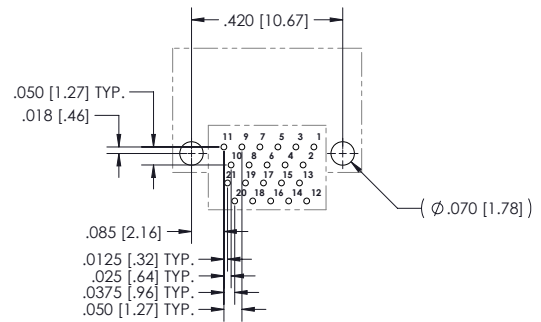

SIZE 21 - VIEW A

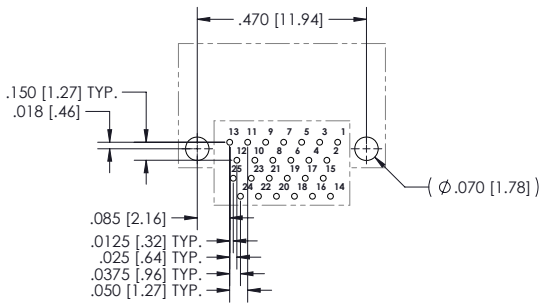

SIZE 25 - VIEW A

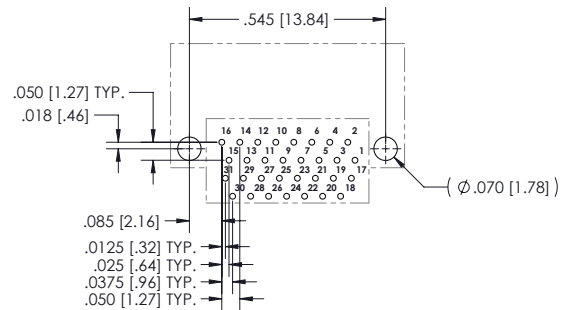

SIZE 31 - VIEW A

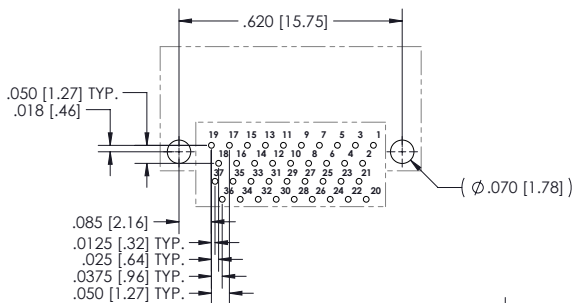

SIZE 37 - VIEW A

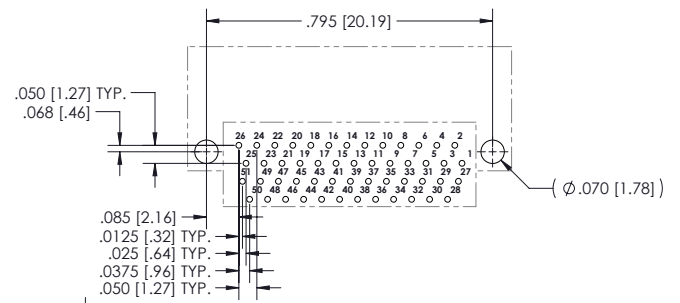

SIZE 51 - VIEW A

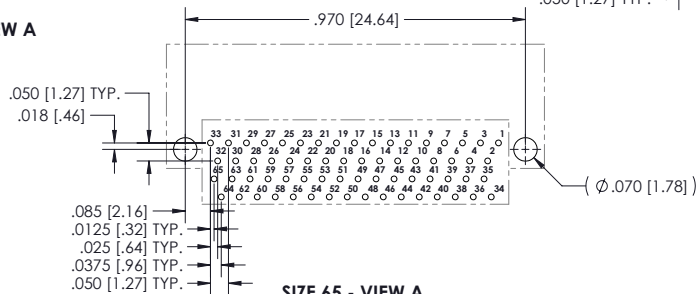

SIZE 65 - VIEW A

CIRCUIT CONNECTOR RIGHT ANGLE



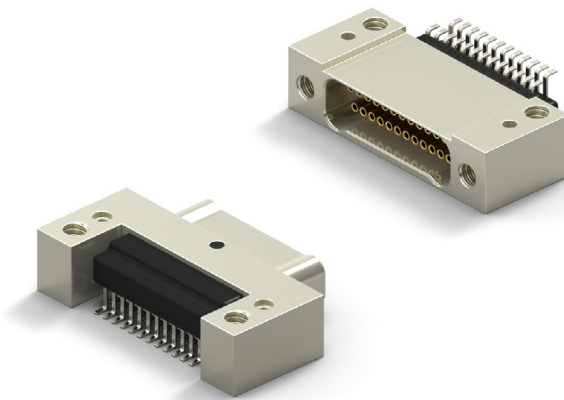









- Metal Shell Connector
- Surface Mount .025 x .040 (Style 28)
- 1 Piece Contact
- Flat Tail Termination
- Operating Temperature -50° C to 200° C
- 9 to 65 Contacts



HOW TO ORDER

* Indicates preferred standard ** Consult factory for other plating options

CN M 28 L 25 - 2 P Ø7 1 - SØ1

CN	Series	Style	Insulator	Contacts	Insulator Type	Contact Gender	Hardware	Color Code	Finish**	Temp Range	Mounting Option
CN=Nano	M= Metal Shell	Style=28	L=LCP	Ø9	2= Dual Row	P=Male/Pin (Plug Side)	Ø7=Threaded Hole	1= Tin plated (6Ø/4Ø)	Blank= Cadmium	*blank = 125C	*Blank=Threaded Mounting Holes
				15				2= Gold plated (RoHS)		HT = 200°C	
				21		S=Female/Socket (Receptacle Side)			*SØ1= Nickel		1=Solder Alignment Posts with Threaded Mounting Holes
				25							
				31					SØ3 = Black Anodize		2=Clearance Mounting Holes
				37							
				51					SØ6 = Olive-Drab Cadmium		3=Solder Alignment Posts with Clearance Mounting Holes
				65							
									SØ7 =Titanium		
											
									SØ9=Stainless		
											

ELECTRICAL PERFORMANCE DATA	Go to Page 26 See chart 133 E or Click Here for Electrical Performance Data
MECHANICAL PERFORMANCE DATA	Go to Page 26 See chart 123 M or Click Here for Mechanical Performance Data
MATERIALS DATA	Go to Page 26 See chart 131 M&F or Click Here for Materials and Finishes Data

DIMENSIONS

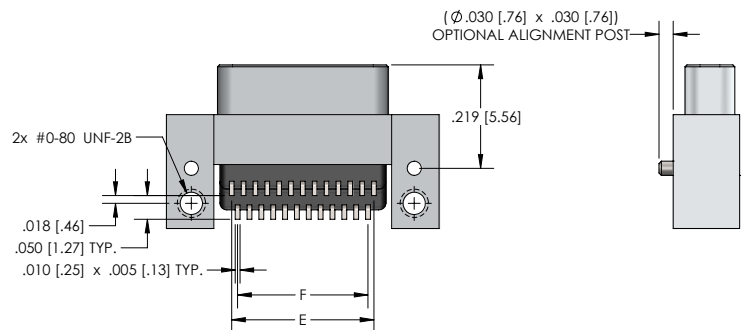
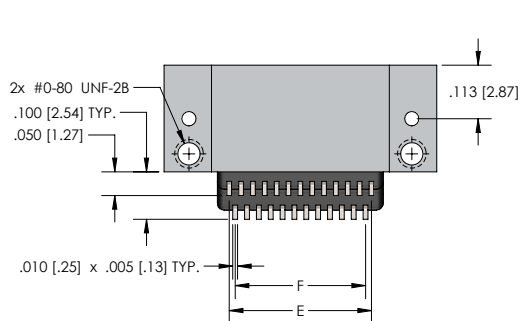
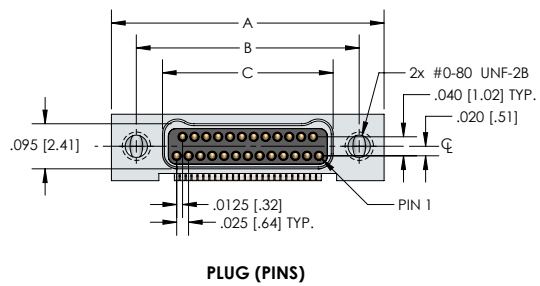
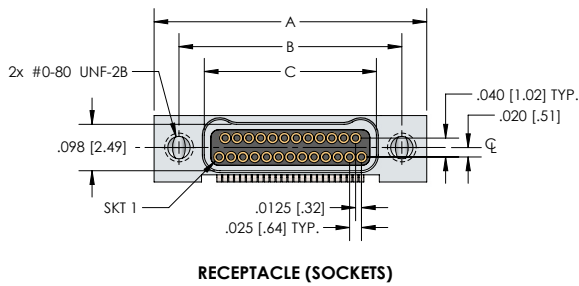
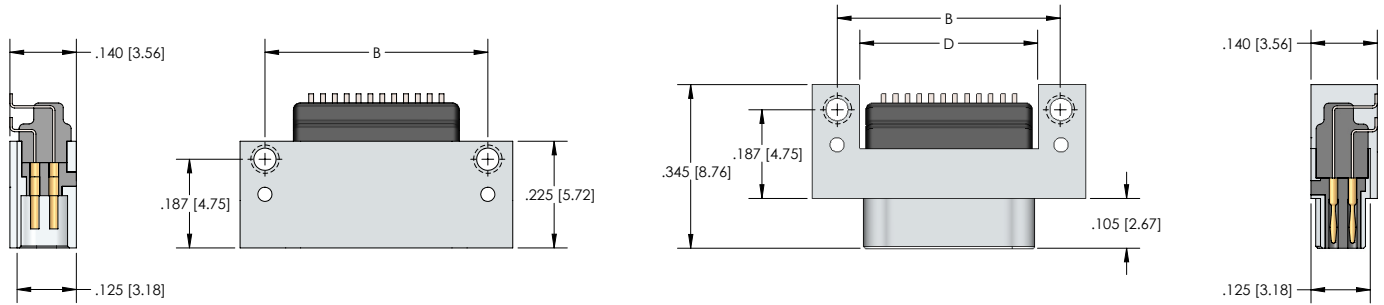

Size	CNM SERIES							
	A	B	Plug	C	Receptacle	D	E	F
9	.375 [9.52]	.270 [6.86]	.160 [4.06]		.163 [4.14]	.175 [4.44]	.100 [2.54]	.075 [1.90]
15	.450 [11.43]	.345 [8.76]	.235 [5.97]		.238 [6.04]	.250 [6.35]	.175 [4.44]	.150 [3.81]
21	.525 [13.33]	.420 [10.67]	.310 [7.87]		.313 [7.95]	.325 [8.25]	.250 [6.35]	.225 [5.71]
25	.575 [14.60]	.470 [11.94]	.360 [9.14]		.363 [9.22]	.375 [9.52]	.300 [7.62]	.275 [6.98]
31	.650 [16.51]	.545 [13.84]	.435 [11.05]		.438 [11.12]	.450 [11.43]	.375 [9.52]	.350 [8.89]
37	.725 [18.41]	.620 [15.75]	.510 [12.95]		.513 [13.03]	.525 [13.33]	.450 [11.43]	.425 [10.79]
51	.900 [22.86]	.795 [20.19]	.685 [17.40]		.688 [17.47]	.700 [17.78]	.625 [15.87]	.600 [15.24]
65	1.075 [27.30]	.970 [24.64]	.860 [21.84]		.863 [21.92]	.875 [22.22]	.800 [20.32]	.775 [19.68]

CIRCUIT CONNECTOR RIGHT ANGLE PCB LAYOUT

NANO D – PID 135

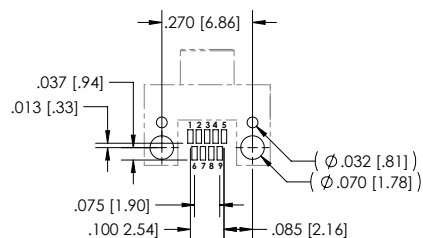
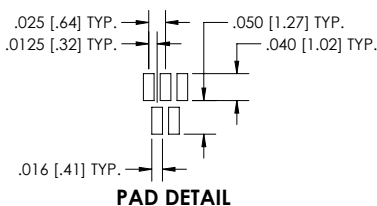
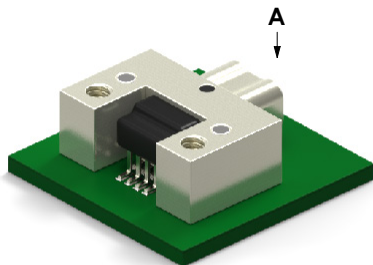

SIZE 9 - VIEW A

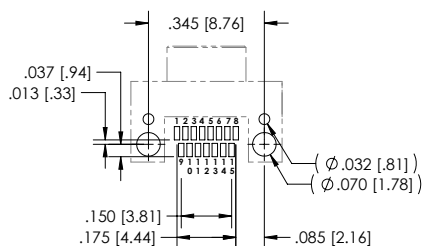

SIZE 15 - VIEW A

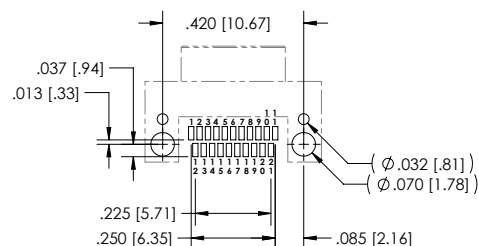

SIZE 21 - VIEW A

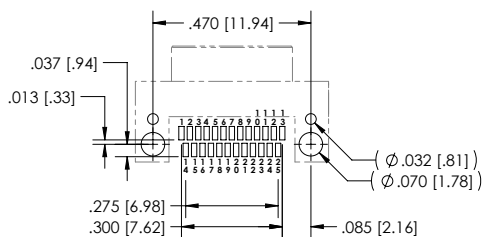

SIZE 25 - VIEW A

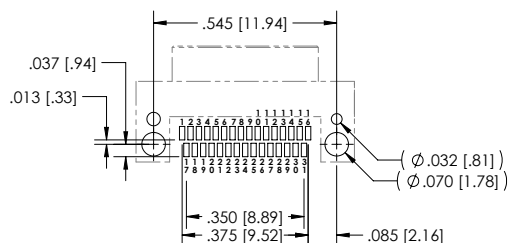

SIZE 31 - VIEW A

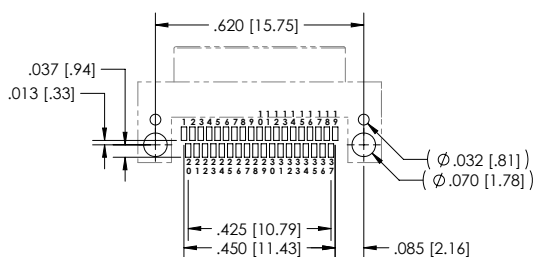

SIZE 37 - VIEW A

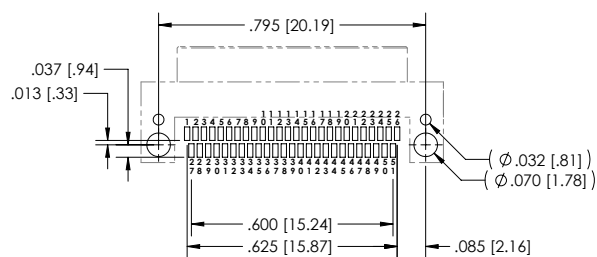

SIZE 51 - VIEW A

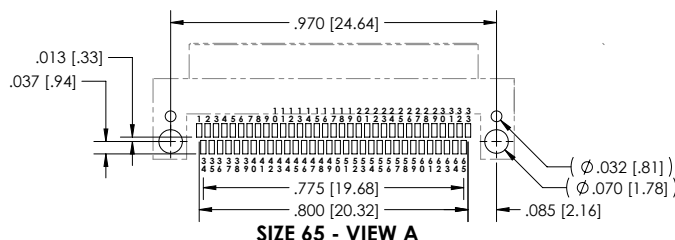

SIZE 65 - VIEW A

CIRCUIT CONNECTOR RIGHT ANGLE PCB LAYOUT

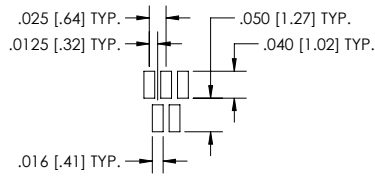
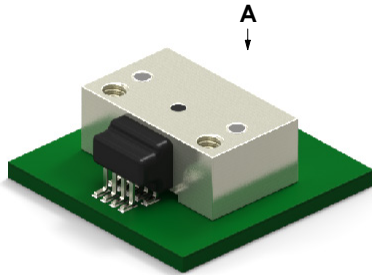

PAD DETAIL

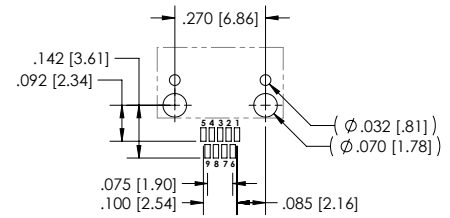

SIZE 9 - VIEW A

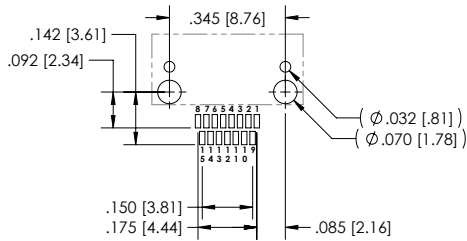

SIZE 15 - VIEW A

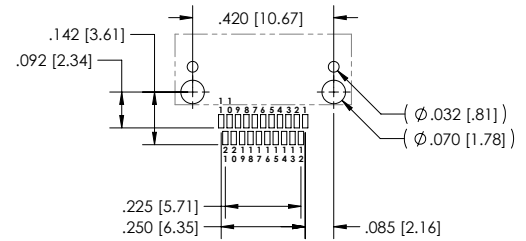

SIZE 21 - VIEW A

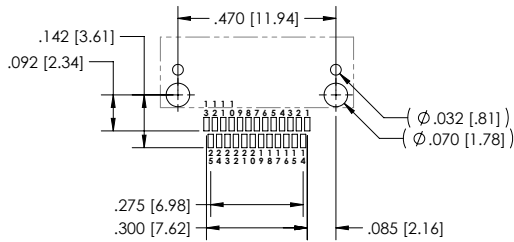

SIZE 25 - VIEW A

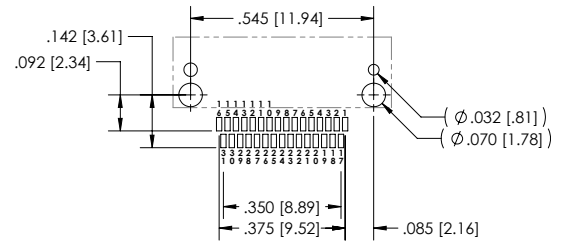

SIZE 31 - VIEW A

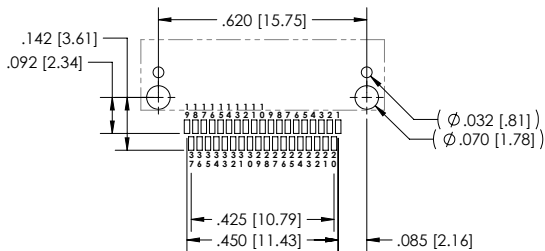

SIZE 37 - VIEW A

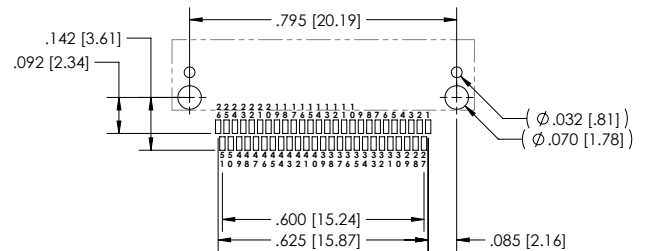

SIZE 51 - VIEW A

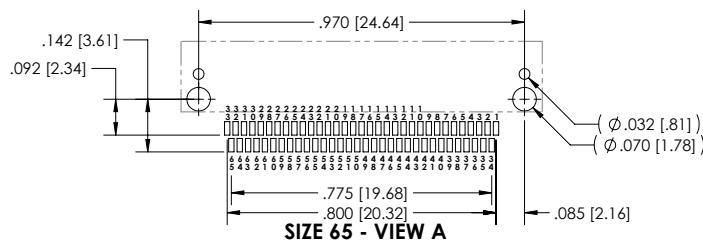

SIZE 65 - VIEW A



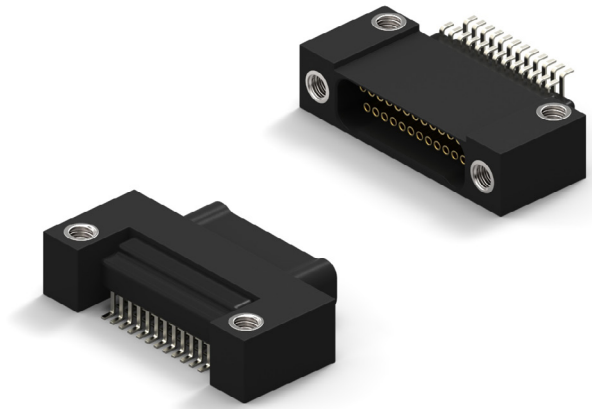

CIRCUIT CONNECTOR RIGHT ANGLE

- Plastic Shell Connector
- Surface Mount .025 x .040 (Style 28)
- 1 Piece Contact
- Flat Tail Termination
- Operating Temperature -50° C to 200° C
- 9 to 65 Contacts



HOW TO ORDER

* Indicates preferred standard

CN	P	28	L	25 - 2	P	Ø7	1			
Series	Style	Insulator	Contacts	Insulator Type	Contact Gender	Hardware	Color Code	Temp Range	Mounting Option	
CN= Nano	P= Plastic Shell	Style=28	L=LCP	Ø9	2= Dual Row	P= Male/ Pin (Plug Side)	Ø7= Threaded Hole	1= Tin plated (6Ø/4Ø)	*blank = 125C	*Blank= Threaded Mounting Holes
				15				2= Gold plated (RoHS)	HT = 200°C	
				21		S= Female/ Socket (Receptacle Side)				
				25						
				31						
				37						
				51						
				65						

ELECTRICAL PERFORMANCE DATA	Go to Page 26 See chart 133 E or Click Here for Electrical Performance Data
MECHANICAL PERFORMANCE DATA	Go to Page 26 See chart 123 M or Click Here for Mechanical Performance Data
MATERIALS DATA	Go to Page 26 See chart 126 M&F or Click Here for Materials and Finishes Data

NANO D – PID 136

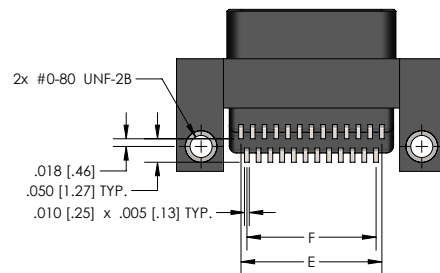
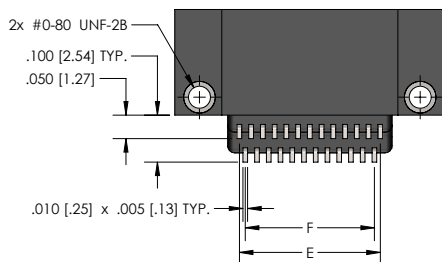
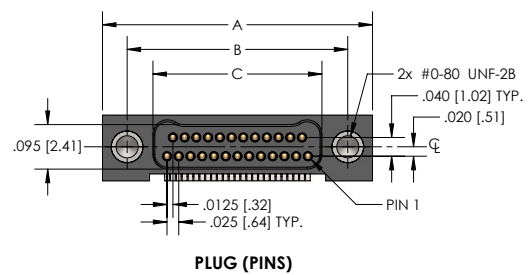
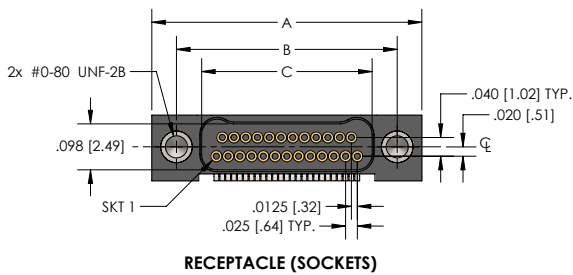
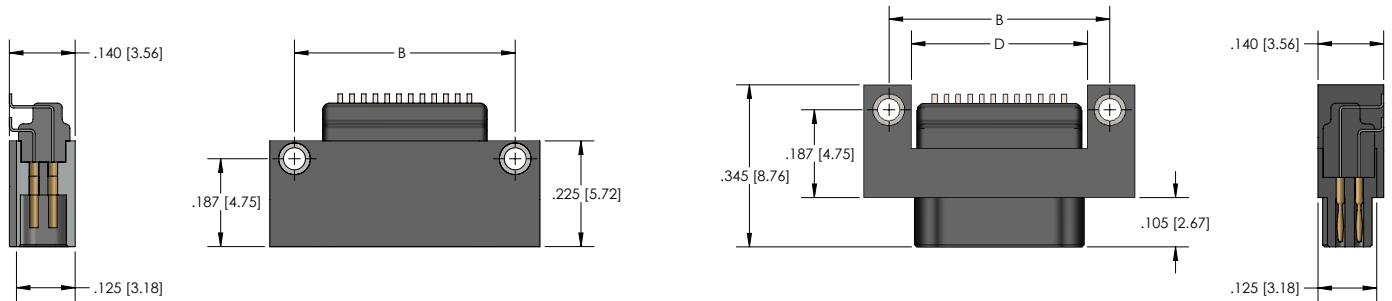

CNP SERIES								
Size	A	B	Plug	C	Receptacle	D	E	F
9	.375 [9.52]	.270 [6.86]	.160 [4.06]		.163 [4.14]	.175 [4.44]	.100 [2.54]	.075 [1.90]
15	.450 [11.43]	.345 [8.76]	.235 [5.97]		.238 [6.04]	.250 [6.35]	.175 [4.44]	.150 [3.81]
21	.525 [13.33]	.420 [10.67]	.310 [7.87]		.313 [7.95]	.325 [8.25]	.250 [6.35]	.225 [5.71]
25	.575 [14.60]	.470 [11.94]	.360 [9.14]		.363 [9.22]	.375 [9.52]	.300 [7.62]	.275 [6.98]
31	.650 [16.51]	.545 [13.84]	.435 [11.05]		.438 [11.12]	.450 [11.43]	.375 [9.52]	.350 [8.89]
37	.725 [18.41]	.620 [15.75]	.510 [12.95]		.513 [13.03]	.525 [13.33]	.450 [11.43]	.425 [10.79]
51	.900 [22.86]	.795 [20.19]	.685 [17.40]		.688 [17.47]	.700 [17.78]	.625 [15.87]	.600 [15.24]
65	1.075 [27.30]	.970 [24.64]	.860 [21.84]		.863 [21.92]	.875 [22.22]	.800 [20.32]	.775 [19.68]

CIRCUIT CONNECTOR RIGHT ANGLE PCB LAYOUT

NANO D – PID 136

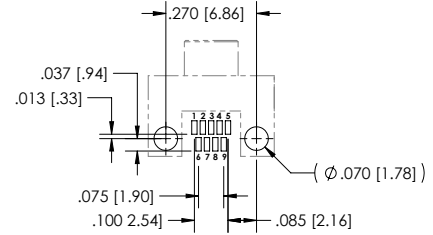
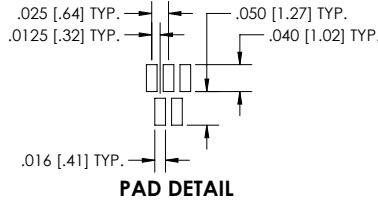
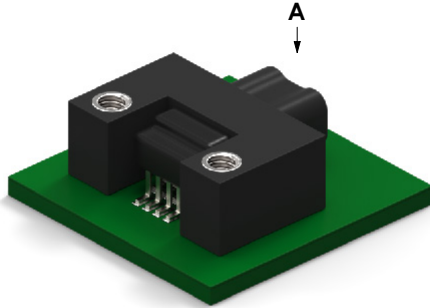

SIZE 9 - VIEW A

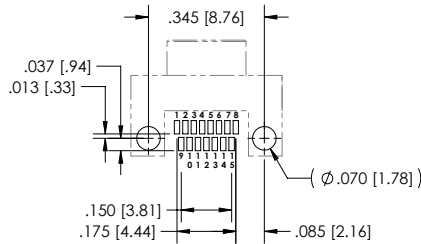

SIZE 15 - VIEW A

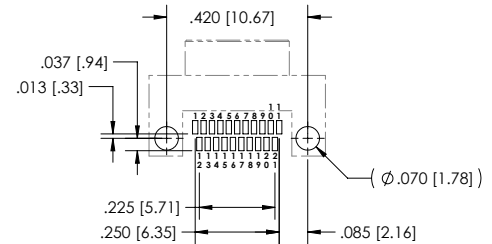

SIZE 21 - VIEW A

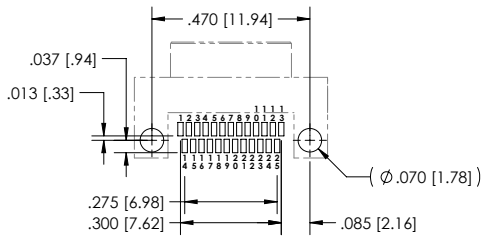

SIZE 25 - VIEW A

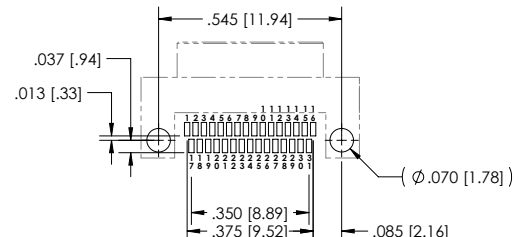

SIZE 31 - VIEW A

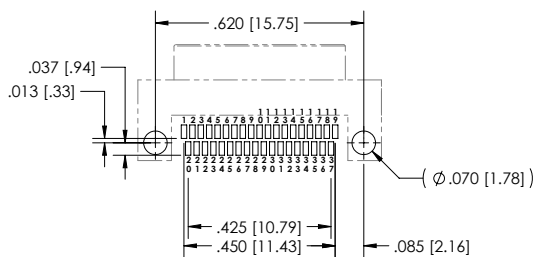

SIZE 37 - VIEW A

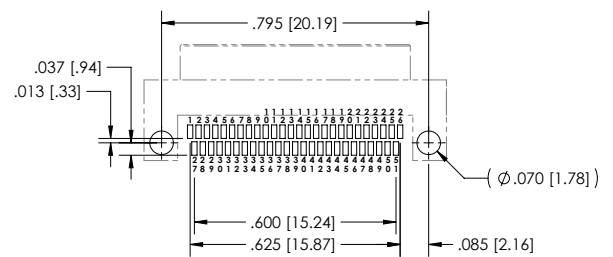

SIZE 51 - VIEW A

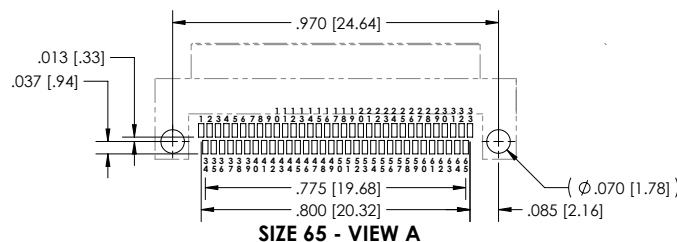

SIZE 65 - VIEW A

CIRCUIT CONNECTOR RIGHT ANGLE PCB LAYOUT

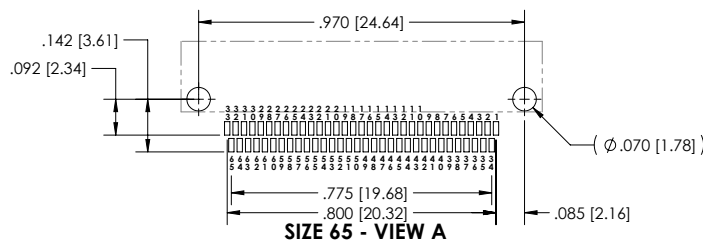
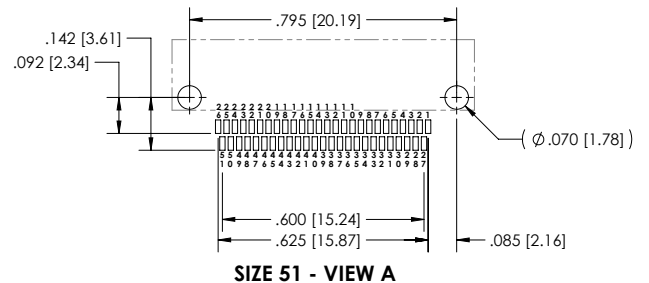
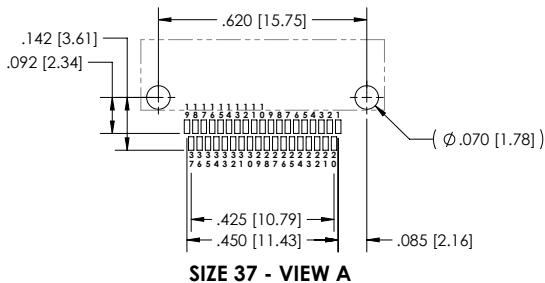
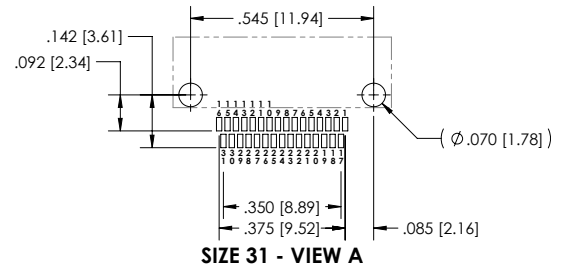
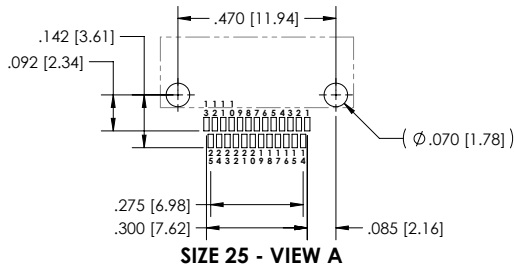
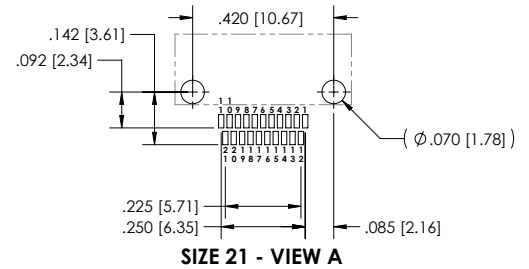
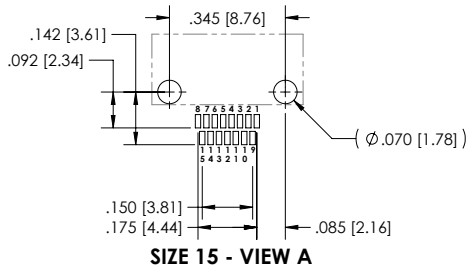
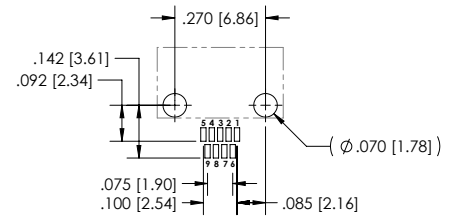
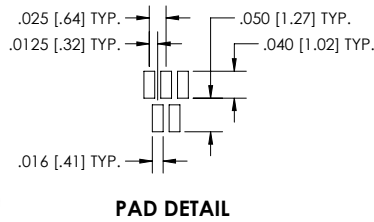
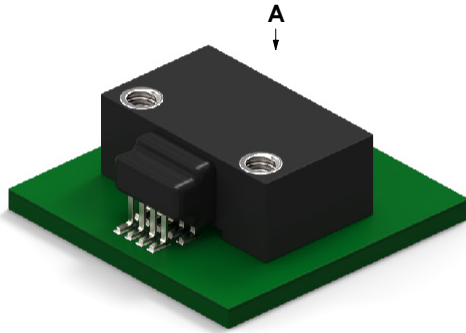

CIRCUIT CONNECTOR RIGHT ANGLE



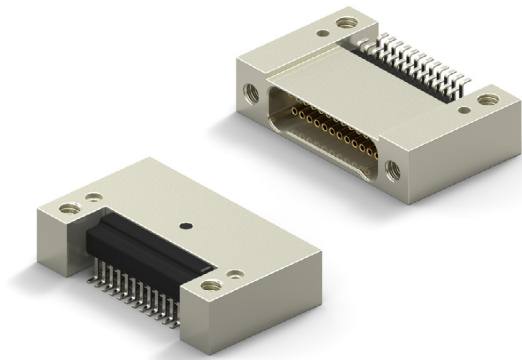









- Metal Shell Connector
- Surface Mount .025 x .040 (Style 38)
- 1 Piece Contact
- Flat Tail Termination
- Operating Temperature -50° C to 200° C
- 9 to 65 Contacts



HOW TO ORDER

* Indicates preferred standard ** Consult factory for other plating options

CN M 38 L 25 - 2 P Ø7 1 - SØ1

CN	Series	Style	Insulator	Contacts	Insulator Type	Contact Gender	Hardware	Color Code	Finish**	Temp Range	Mounting Option
CN=Nano	M= Metal Shell	STYLE=38	L=LCP	Ø9	2= Dual Row	S= Female/Socket (Receptacle Side)	Ø7=Threaded Hole	1= Tin plated (6Ø/4Ø)	Blank= Cadmium	*blank = 125C	*Blank=Threaded Mounting Holes
				15				2= Gold plated (RoHS)		HT = 2ØØC	
				21					*SØ1= Nickel		1= Solder Alignment Posts with Threaded Mounting Holes
				25							
				31					SØ3 = Black Anodize		2= Clearance Mounting Holes
				37							
				51					SØ6 = Olive-Drab Cadmium		3= Solder Alignment Posts with Clearance Mounting Holes
				65							
									SØ7 =Titanium		
											
									SØ9=Stainless		
											

ELECTRICAL PERFORMANCE DATA	Go to Page 26 See chart 133 E or Click Here for Electrical Performance Data
MECHANICAL PERFORMANCE DATA	Go to Page 26 See chart 123 M or Click Here for Mechanical Performance Data
MATERIALS DATA	Go to Page 26 See chart 131 M&F or Click Here for Materials and Finishes Data

DIMENSIONS

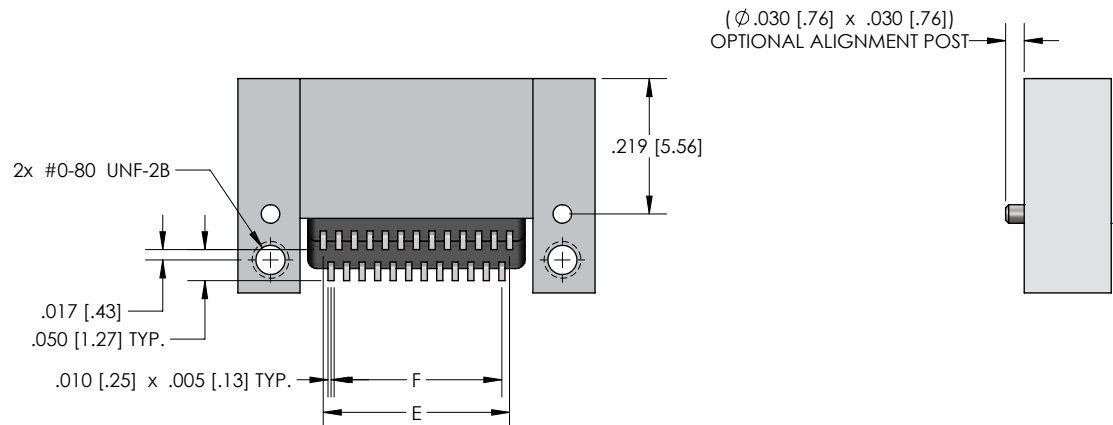
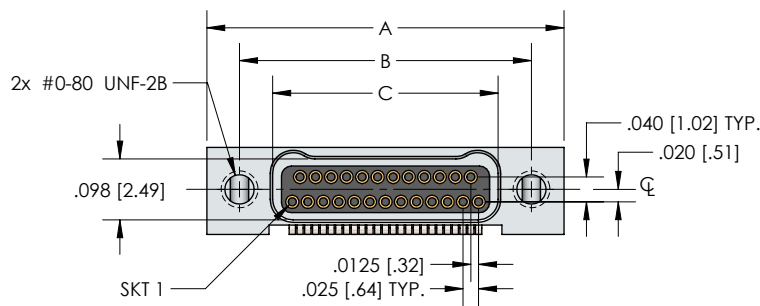
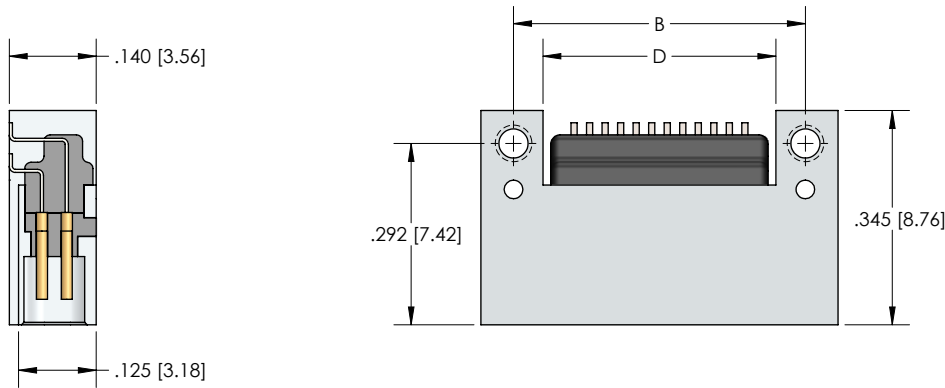

Size	CNM SERIES						
	A	B	Plug	C	Receptacle	D	E
9	.375 [9.52]	.270 [6.86]	.160 [4.06]	.163 [4.14]	.175 [4.44]	.100 [2.54]	.075 [1.90]
15	.450 [11.43]	.345 [8.76]	.235 [5.97]	.238 [6.04]	.250 [6.35]	.175 [4.44]	.150 [3.81]
21	.525 [13.33]	.420 [10.67]	.310 [7.87]	.313 [7.95]	.325 [8.25]	.250 [6.35]	.225 [5.71]
25	.575 [14.60]	.470 [11.94]	.360 [9.14]	.363 [9.22]	.375 [9.52]	.300 [7.62]	.275 [6.98]
31	.650 [16.51]	.545 [13.84]	.435 [11.05]	.438 [11.12]	.450 [11.43]	.375 [9.52]	.350 [8.89]
37	.725 [18.41]	.620 [15.75]	.510 [12.95]	.513 [13.03]	.525 [13.33]	.450 [11.43]	.425 [10.79]
51	.900 [22.86]	.795 [20.19]	.685 [17.40]	.688 [17.47]	.700 [17.78]	.625 [15.87]	.600 [15.24]
65	1.075 [27.30]	.970 [24.64]	.860 [21.84]	.863 [21.92]	.875 [22.22]	.800 [20.32]	.775 [19.68]

CIRCUIT CONNECTOR RIGHT ANGLE PCB LAYOUT

NANO D – PID 137

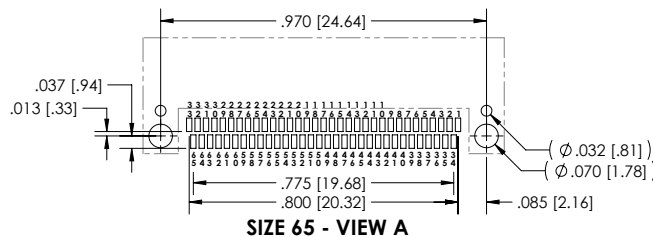
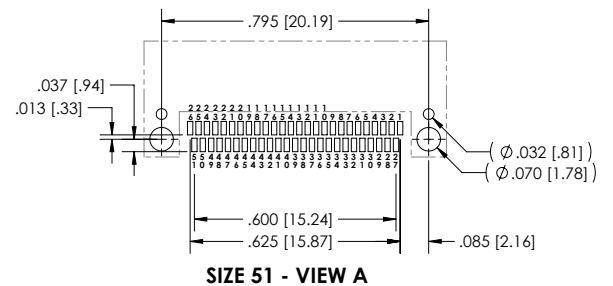
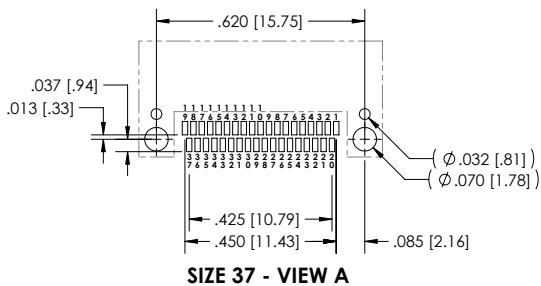
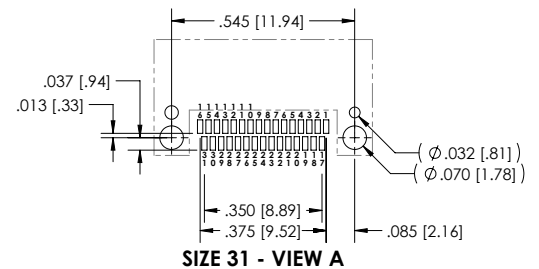
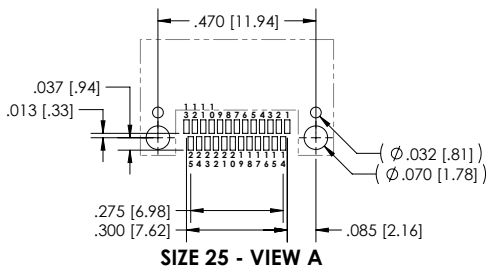
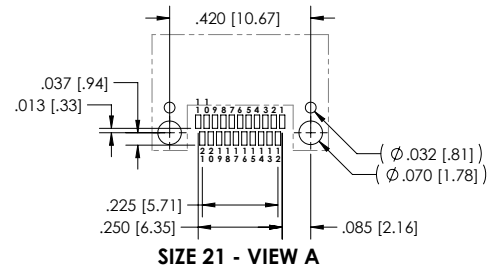
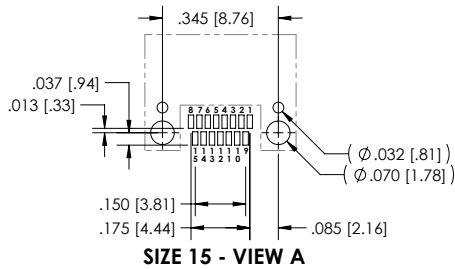
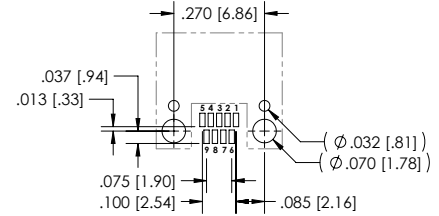
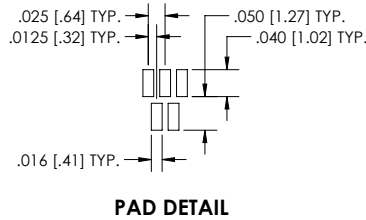
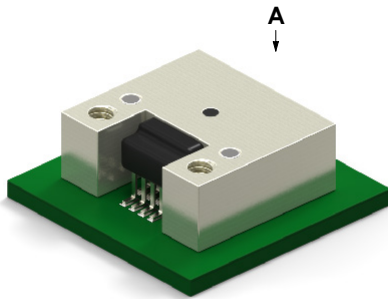

CIRCUIT CONNECTOR RIGHT ANGLE PCB LAYOUT

THIS PAGE LEFT
INTENTIONALLY BLANK

CIRCUIT CONNECTOR RIGHT ANGLE

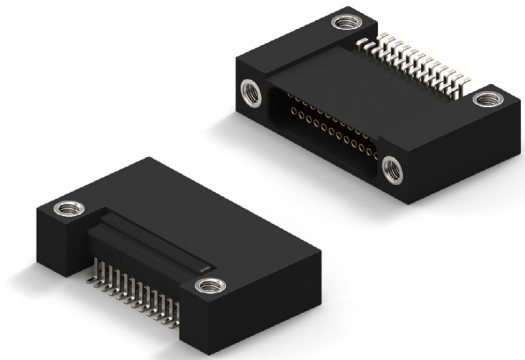

- Plastic Shell Connector
- Surface Mount .025 x .040 (Style 38)
- 1 Piece Contact
- Flat Tail Termination
- Operating Temperature -50° C to 200° C
- 9 to 65 Contacts



NANO D – PID 138

HOW TO ORDER

* Indicates preferred standard

CN	P	38	L	25	- 2	S	Ø7	1		
Series	Style	Insulator	Contacts	Insulator Type	Contact Gender	Hardware	Color Code	Temp Range	Mounting Option	
CN=Nano	P=Plastic	Style=38	L=LCP	Ø9	2= Dual Row	S=Female/Socket (Receptacle Side)	Ø7=Threaded Hole	1= Tin plated (6Ø/4Ø)	*blank = 125C	*Blank=Threaded Mounting Holes
				15				2= Gold plated (RoHS)	HT = 200C	
				21						
				25						
				31						
				37						
				51						
				65						

ELECTRICAL PERFORMANCE DATA	Go to Page 26 See chart 133 E or Click Here for Electrical Performance Data
MECHANICAL PERFORMANCE DATA	Go to Page 26 See chart 123 M or Click Here for Mechanical Performance Data
MATERIALS DATA	Go to Page 26 See chart 126 M&F or Click Here for Materials and Finishes Data

DIMENSIONS

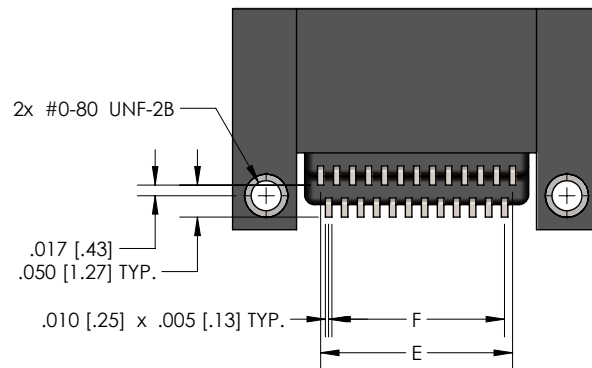
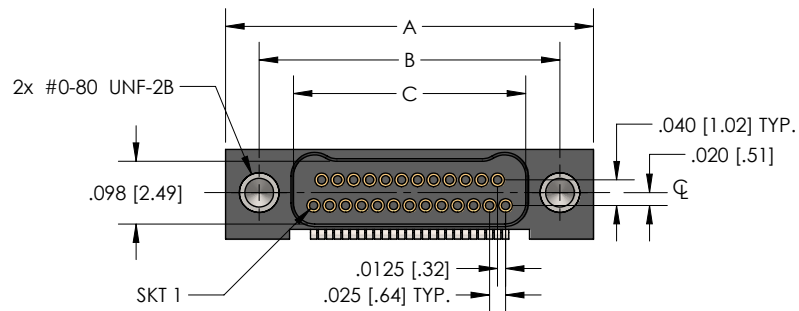
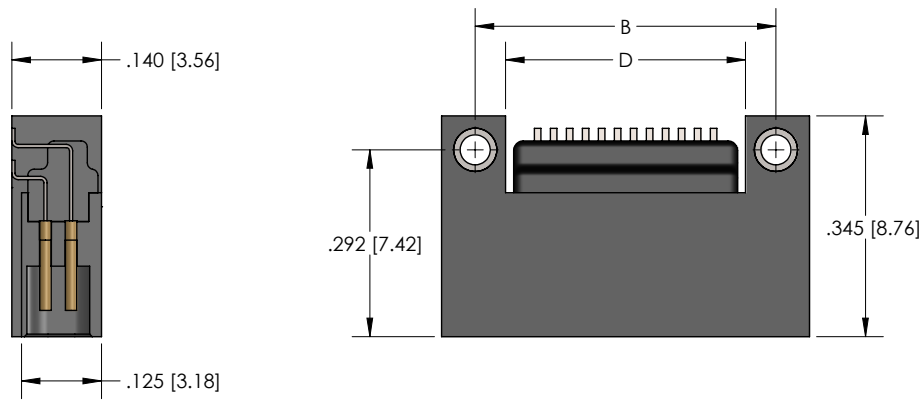

CNP SERIES								
Size	A	B	Plug C	Receptacle	D	E	F	
9	.375 [9.52]	.270 [6.86]	.160 [4.06]	.163 [4.14]	.175 [4.44]	.100 [2.54]	.075 [1.90]	
15	.450 [11.43]	.345 [8.76]	.235 [5.97]	.238 [6.04]	.250 [6.35]	.175 [4.44]	.150 [3.81]	
21	.525 [13.33]	.420 [10.67]	.310 [7.87]	.313 [7.95]	.325 [8.25]	.250 [6.35]	.225 [5.71]	
25	.575 [14.60]	.470 [11.94]	.360 [9.14]	.363 [9.22]	.375 [9.52]	.300 [7.62]	.275 [6.98]	
31	.650 [16.51]	.545 [13.84]	.435 [11.05]	.438 [11.12]	.450 [11.43]	.375 [9.52]	.350 [8.89]	
37	.725 [18.41]	.620 [15.75]	.510 [12.95]	.513 [13.03]	.525 [13.33]	.450 [11.43]	.425 [10.79]	
51	.900 [22.86]	.795 [20.19]	.685 [17.40]	.688 [17.47]	.700 [17.78]	.625 [15.87]	.600 [15.24]	
65	1.075 [27.30]	.970 [24.64]	.860 [21.84]	.863 [21.92]	.875 [22.22]	.800 [20.32]	.775 [19.68]	

CIRCUIT CONNECTOR RIGHT ANGLE PCB LAYOUT

NANO D – PID 138

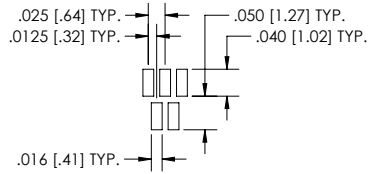
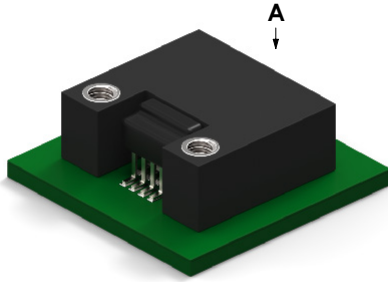

PAD DETAIL

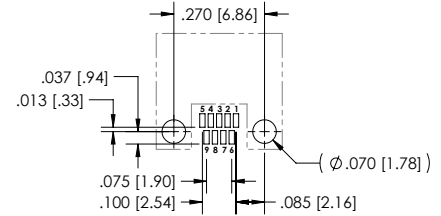

SIZE 9 - VIEW A

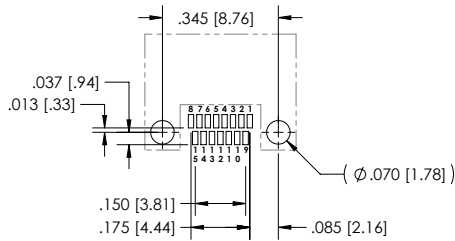

SIZE 15 - VIEW A

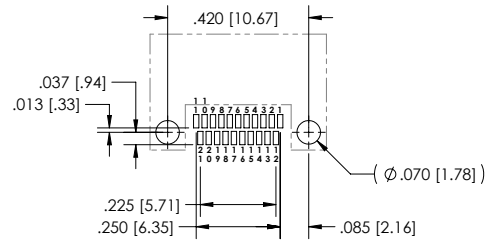

SIZE 21 - VIEW A

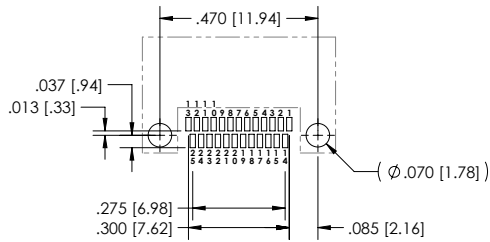

SIZE 25 - VIEW A

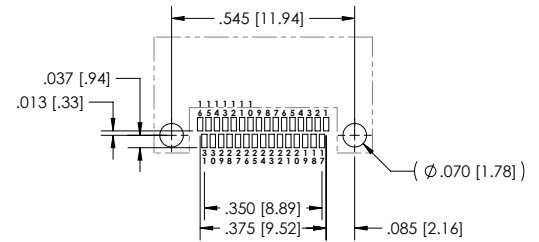

SIZE 31 - VIEW A

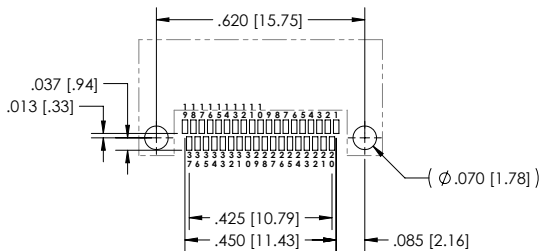

SIZE 37 - VIEW A

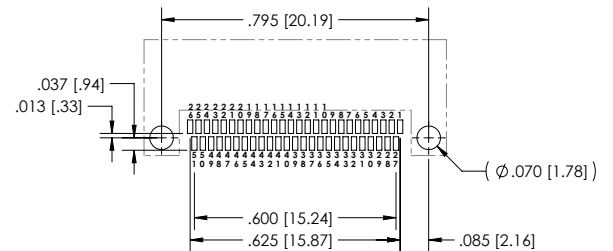

SIZE 51 - VIEW A

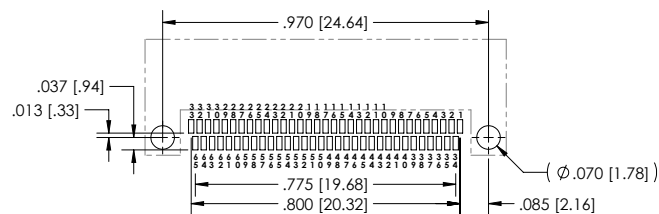

SIZE 65 - VIEW A

CIRCUIT CONNECTOR RIGHT ANGLE PCB LAYOUT

THIS PAGE LEFT
INTENTIONALLY BLANK

CIRCUIT CONNECTOR VERTICAL



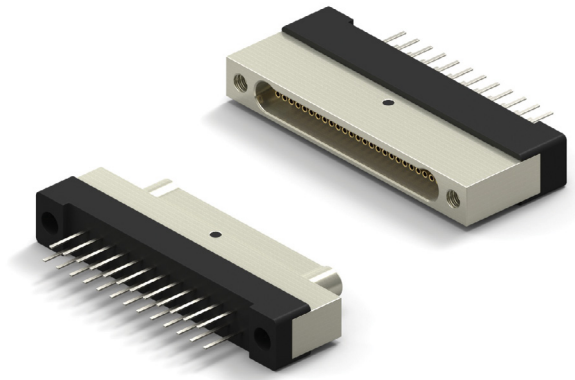





- Metal Shell Connector
- Plated Thru Hole .050 x .050 (Style 6)
- 1 Piece Contact
- Flat Tail Termination
- Operating Temperature -50° C to 200° C
- 9 to 51 Contacts



NANO D – PID 139

HOW TO ORDER

* Indicates preferred standard ** Consult factory for other plating options

CN	M	6	L	25	-1	P	Ø7	1	-SØ1	
	Series	Style	Insulator	Contacts	Insulator Type	Contact Gender	Hardware	Color Code	Finish**	Temp Range
CN=Nano	M= Metal Shell	Style=6	L=LCP	Ø9	1= Single Row	P=Male/Pin (Plug Side)	Ø7=Threaded Hole	1= Tin plated (6Ø/4Ø)	Blank= Cadmium	*blank = 125C
				15				2= Gold plated (RoHS)		HT = 200C
				21		S=Female/Socket (Receptacle Side)			*SØ1= Nickel	
				25						
				31					SØ3 = Black Anodize	
				37						
				51					SØ6 = Olive-Drab Cadmium	
										
									SØ7 =Titanium	
										
									SØ9=Stainless	
										

ELECTRICAL PERFORMANCE DATA	Go to Page 28 See chart 133 E or Click Here for Electrical Performance Data
MECHANICAL PERFORMANCE DATA	Go to Page 28 See chart 123 M or Click Here for Mechanical Performance Data
MATERIALS DATA	Go to Page 28 See chart 139 M&F or Click Here for Materials and Finishes Data

DIMENSIONS

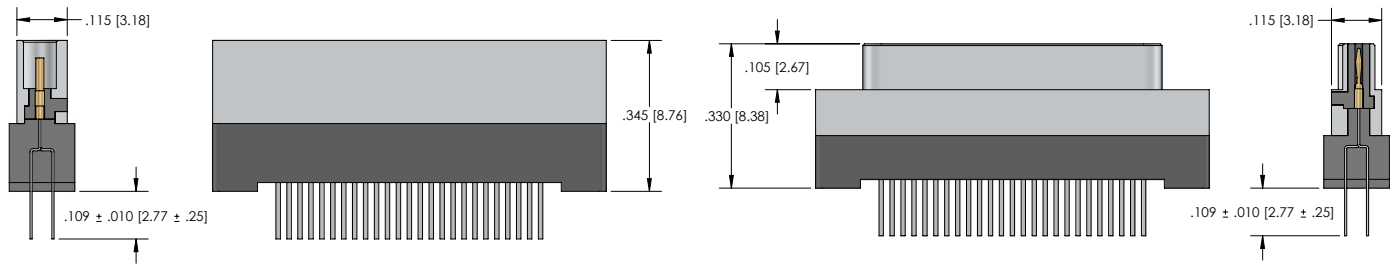
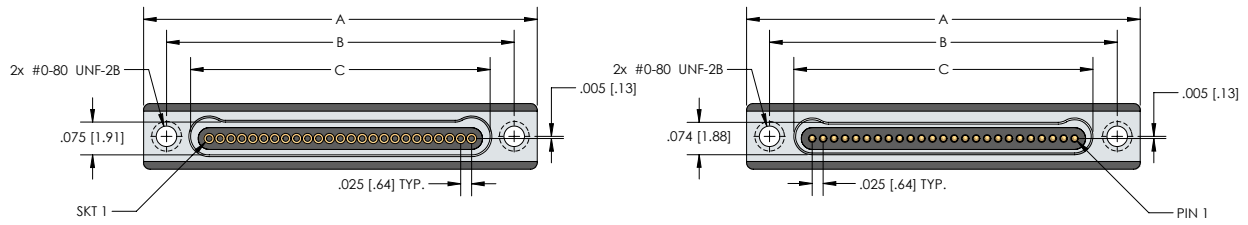

RECEPTACLE (SOCKETS)

PLUG (PINS)

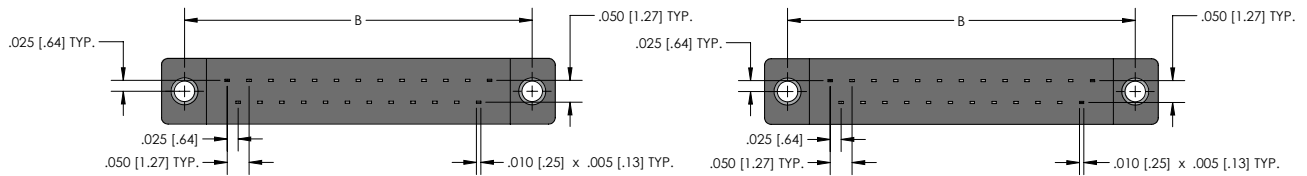

CNM SERIES					
Size	A	B	Plug C	Receptacle	D
9	.500 [12.70]	.395 [10.03]	.284 [7.21]	.285 [7.24]	.300 [7.62]
15	.650 [16.51]	.545 [13.84]	.434 [11.02]	.435 [11.05]	.450 [11.43]
21	.800 [20.32]	.695 [17.65]	.584 [14.83]	.585 [14.86]	.600 [15.24]
25	.900 [22.86]	.795 [20.19]	.684 [17.37]	.685 [17.40]	.700 [17.78]
31	1.050 [26.67]	.945 [24.00]	.834 [21.18]	.835 [21.21]	.850 [21.59]
37	1.200 [30.48]	1.095 [27.81]	.984 [24.99]	.985 [25.02]	1.000 [25.40]
51	1.550 [39.37]	1.445 [36.70]	1.334 [33.88]	1.335 [33.91]	1.350 [34.29]

CIRCUIT CONNECTOR VERTICAL PCB LAYOUT

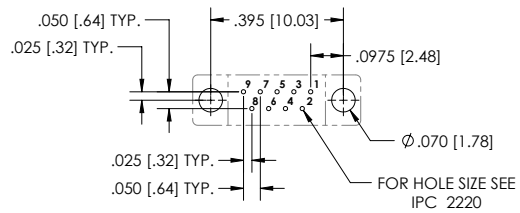
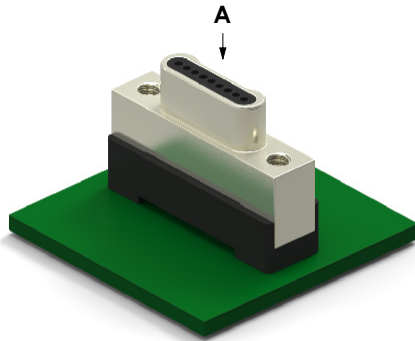

SIZE 9 - VIEW A

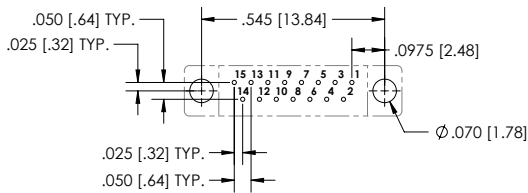

SIZE 15 - VIEW A

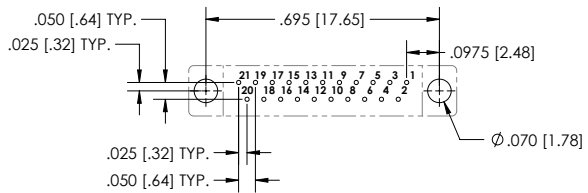

SIZE 21 - VIEW A

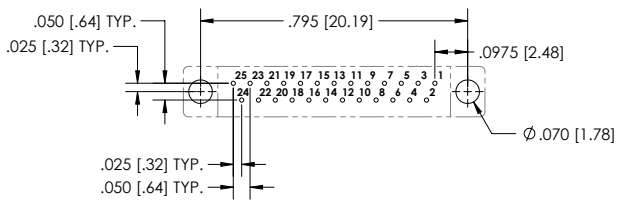

SIZE 25 - VIEW A

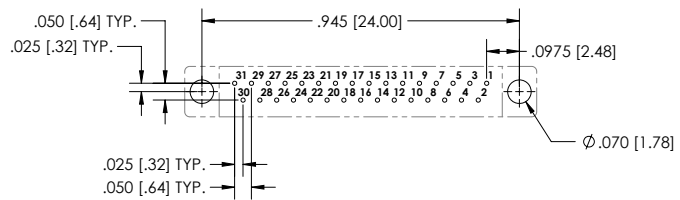

SIZE 31 - VIEW A

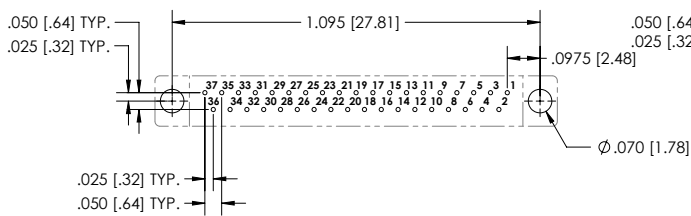

SIZE 37 - VIEW A

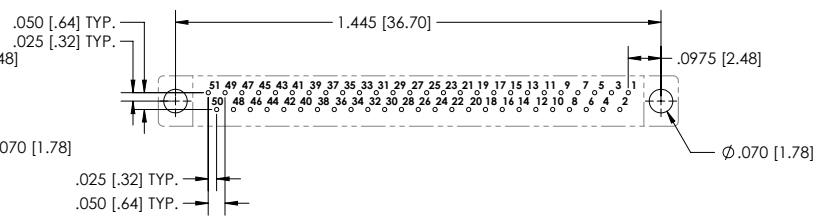

SIZE 51 - VIEW A

CIRCUIT CONNECTOR VERTICAL PCB LAYOUT

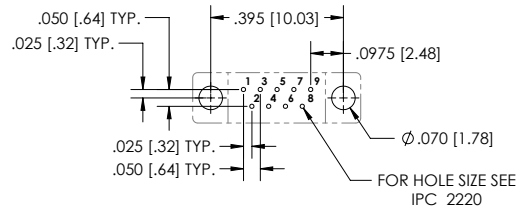
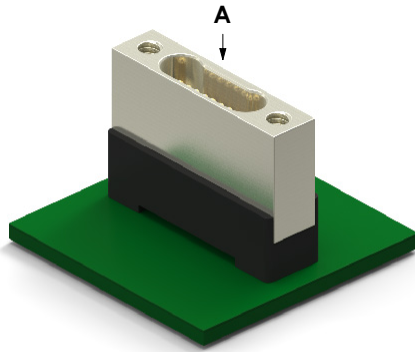

SIZE 9 - VIEW A

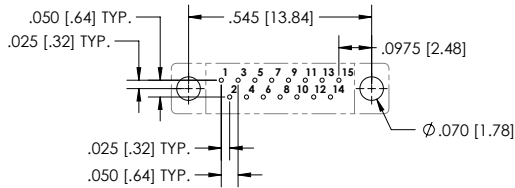

SIZE 15 - VIEW A

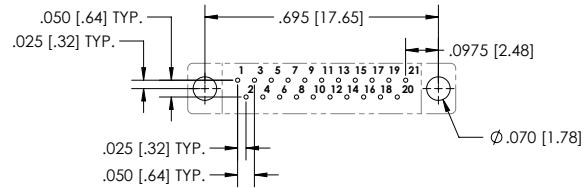

SIZE 21 - VIEW A

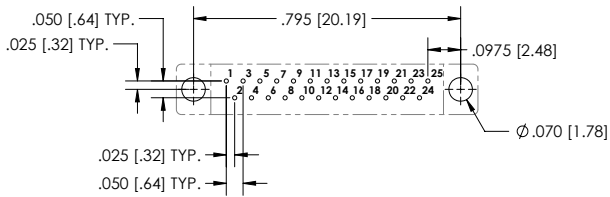

SIZE 25 - VIEW A

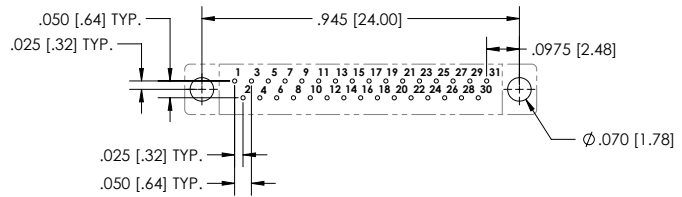

SIZE 31 - VIEW A

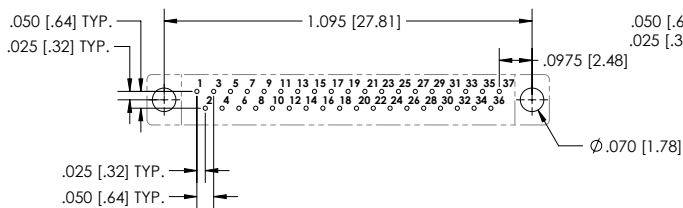

SIZE 37 - VIEW A

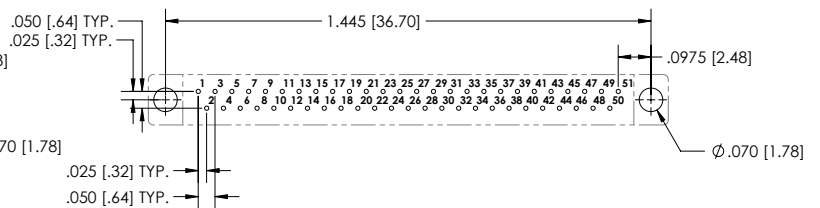

SIZE 51 - VIEW A





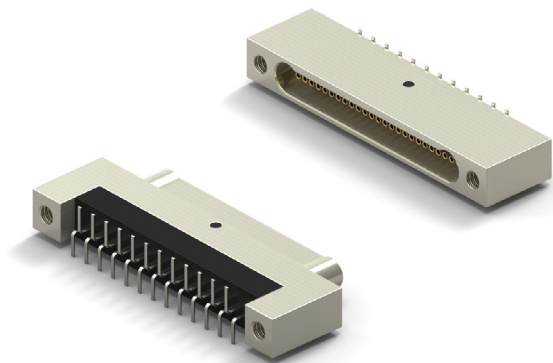



CIRCUIT CONNECTOR VERTICAL

- Metal Shell Connector
- Surface Mount .025 x .075 (Style 26)
- 1 Piece Contact
- Flat Tail Termination
- Operating Temperature -50° C to 200° C
- 9 to 51 Contacts



HOW TO ORDER

* Indicates preferred standard ** Consult factory for other plating options

CN	M	26	L	25	-1	P	Ø7	1	-SØ1	Temp Range
Series	Style	Insulator	Contacts	Insulator Type	Contact Gender	Hardware	Color Code	Finish**		
CN= Nano	M= Metal Shell	Style=26	L=LCP	Ø9	1= Single Row	P= Male/Pin (Plug Side)	Ø7= Threaded Hole	1= Tin plated (6Ø/4Ø)	Blank= Cadmium	*blank = 125C
			15				2= Gold plated (RoHS)			HT = 200C
			21		S= Female/Socket (Receptacle Side)			*SØ1= Nickel		
			25							
			31					SØ3 = Black Anodize		
			37							
			51					SØ6 = Olive-Drab Cadmium		
										
								SØ7 = Titanium		
										
								SØ9 = Stainless		
										

ELECTRICAL PERFORMANCE DATA	Go to Page 28 See chart 133 E or Click Here for Electrical Performance Data
MECHANICAL PERFORMANCE DATA	Go to Page 28 See chart 123 M or Click Here for Mechanical Performance Data
MATERIALS DATA	Go to Page 28 See chart 139 M&F or Click Here for Materials and Finishes Data

DIMENSIONS

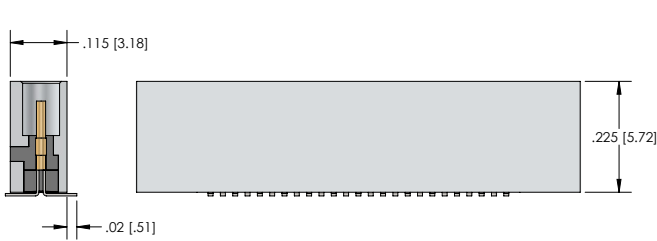
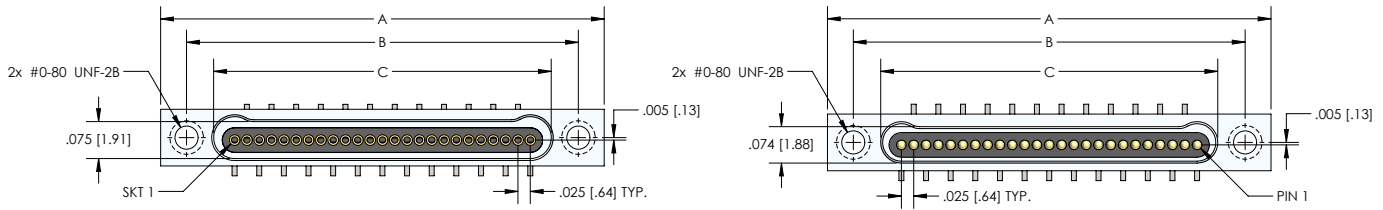

RECEPTACLE (SOCKETS)

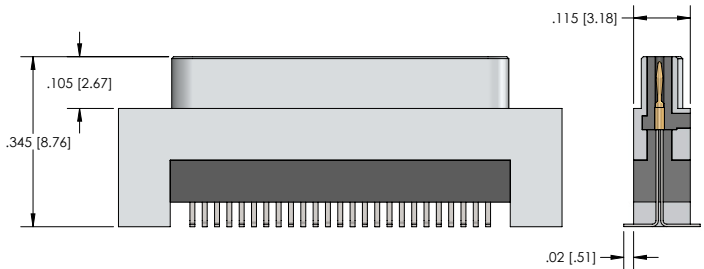

PLUG (PINS)

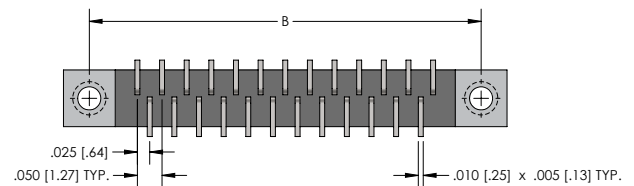
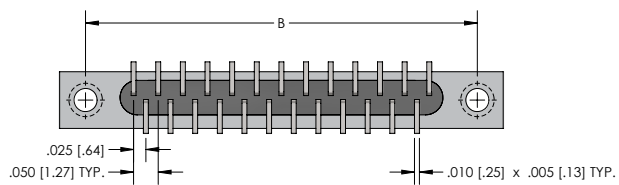

Size	CNM SERIES				
	A	B	Plug C	Receptacle	D
9	.500 [12.70]	.395 [10.03]	.284 [7.21]	.285 [7.24]	.300 [7.62]
15	.650 [16.51]	.545 [13.84]	.434 [11.02]	.435 [11.05]	.450 [11.43]
21	.800 [20.32]	.695 [17.65]	.584 [14.83]	.585 [14.86]	.600 [15.24]
25	.900 [22.86]	.795 [20.19]	.684 [17.37]	.685 [17.40]	.700 [17.78]
31	1.050 [26.67]	.945 [24.00]	.834 [21.18]	.835 [21.21]	.850 [21.59]
37	1.200 [30.48]	1.095 [27.81]	.984 [24.99]	.985 [25.02]	1.000 [25.40]
51	1.550 [39.37]	1.445 [36.70]	1.334 [33.88]	1.335 [33.91]	1.350 [34.29]

CIRCUIT CONNECTOR VERTICAL PCB LAYOUT

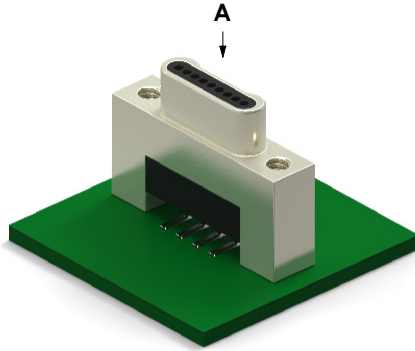

NANO D – PID 140

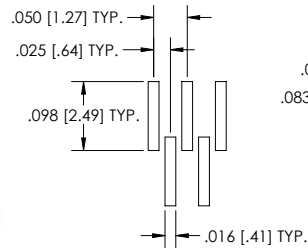

PAD DETAIL

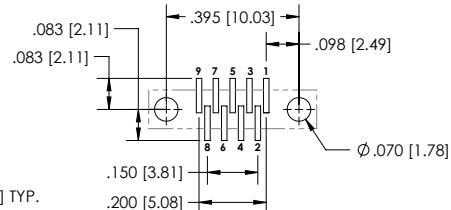

SIZE 9 - VIEW A

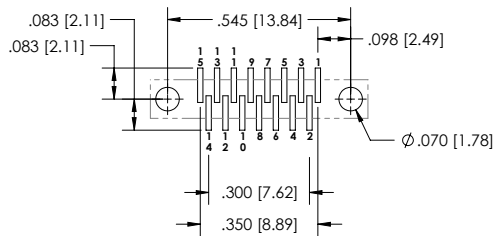

SIZE 15 - VIEW A

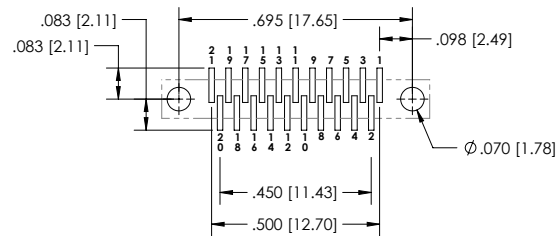

SIZE 21 - VIEW A

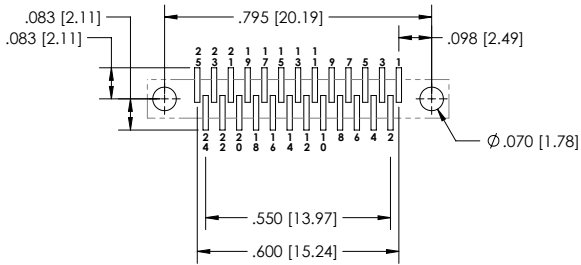

SIZE 25 - VIEW A

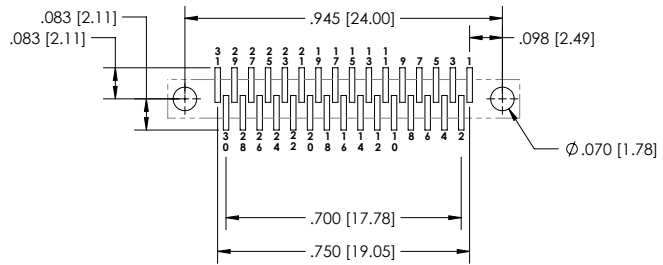

SIZE 31 - VIEW A

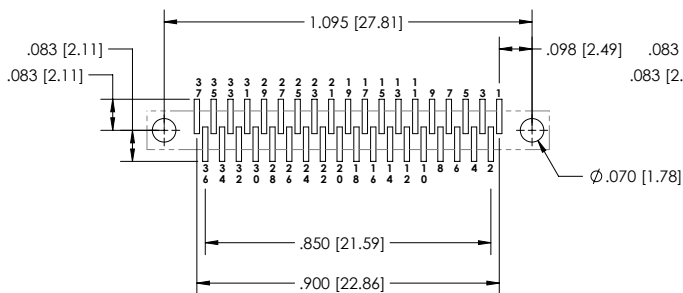

SIZE 37 - VIEW A

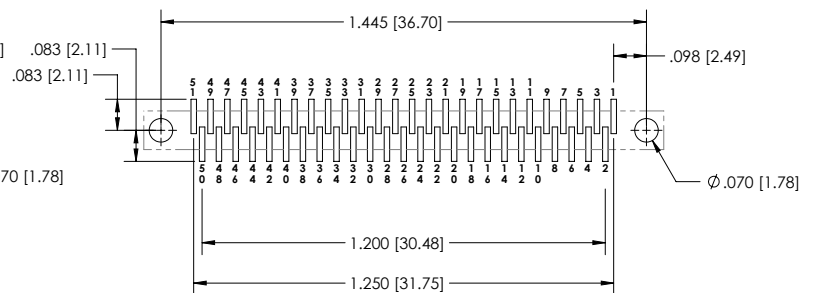

SIZE 51 - VIEW A

CIRCUIT CONNECTOR VERTICAL PCB LAYOUT

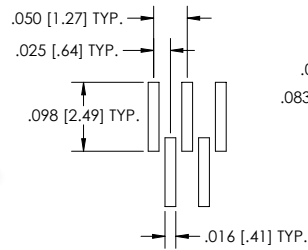
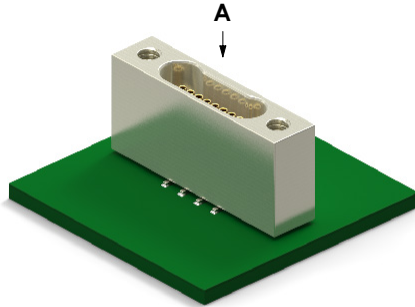

PAD DETAIL

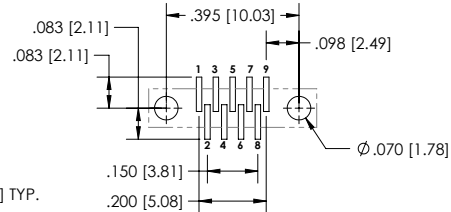

SIZE 9 - VIEW A

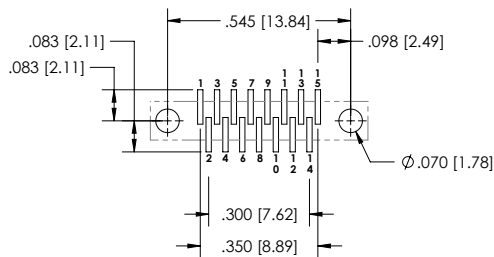

SIZE 15 - VIEW A

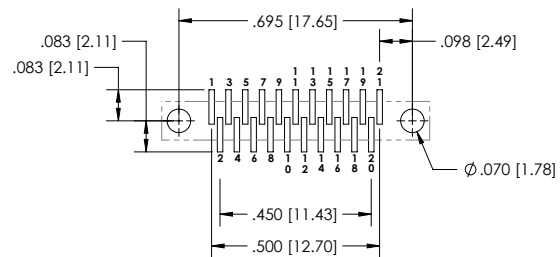

SIZE 21 - VIEW A

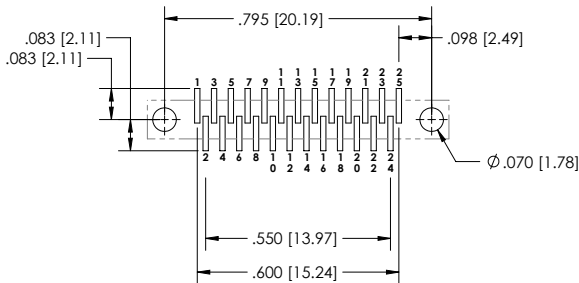

SIZE 25 - VIEW A

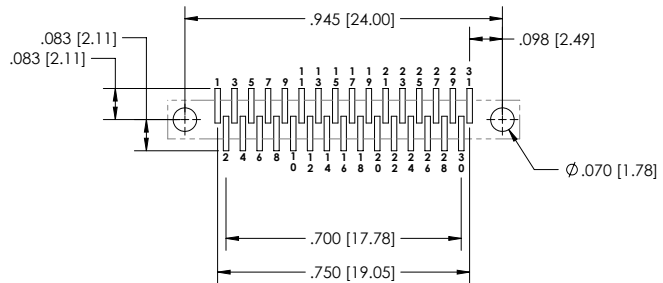

SIZE 31 - VIEW A

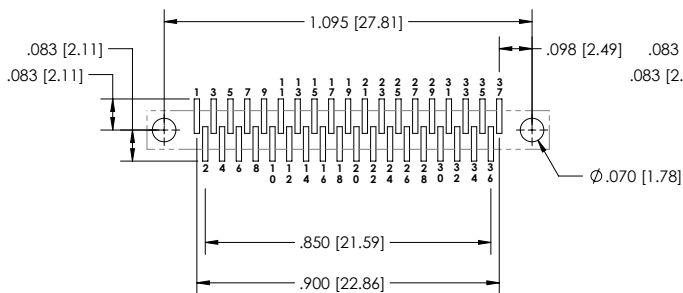

SIZE 37 - VIEW A

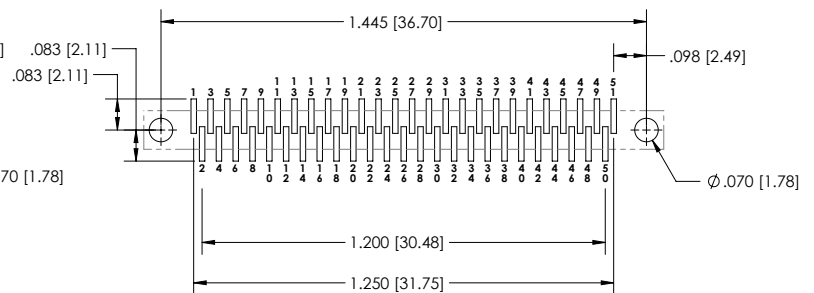

SIZE 51 - VIEW A





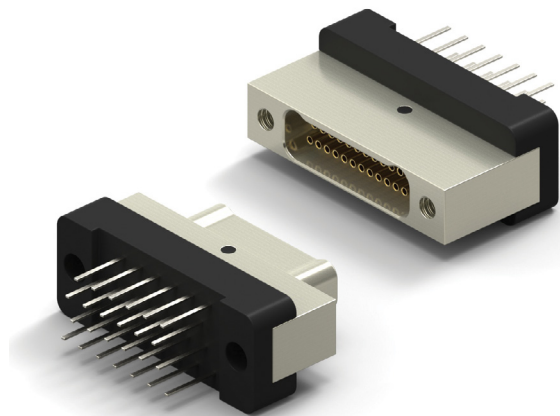



CIRCUIT CONNECTOR VERTICAL

- Metal Shell Connector
- Plated Thru Hole .050 x .050 (Style 6)
- 1 Piece Contact
- Flat Tail Termination
- Operating Temperature -50° C to 200° C
- 9 to 65 Contacts



HOW TO ORDER

* Indicates preferred standard ** Consult factory for other plating options

CN	M	6	L	25	-2	P	Ø7	1	-SØ1	
Series	Style	Insulator	Contacts	Insulator Type	Contact Gender	Hardware	Color Code	Finish**	Temp Range	
CN= Nano	M= Metal Shell	Style=6	L=LCP	Ø9	2= Dual Row	P= Male/Pin (Plug Side)	Ø7= Threaded Hole	1= Tin plated (6Ø/4Ø)	Blank= Cadmium	*blank = 125C
			15				2= Gold plated (RoHS)		HT = 200C	
			21		S= Female/Socket (Receptacle Side)			*SØ1= Nickel		
			25						SØ3 = Black Anodize	
			31						SØ6 = Olive-Drab Cadmium	
			37						SØ7 = Titanium	
			51						SØ9 = Stainless	
			65							

ELECTRICAL PERFORMANCE DATA	Go to Page 29 See chart 133 E or Click Here for Electrical Performance Data
MECHANICAL PERFORMANCE DATA	Go to Page 29 See chart 123 M or Click Here for Mechanical Performance Data
MATERIALS DATA	Go to Page 29 See chart 139 M&F or Click Here for Materials and Finishes Data

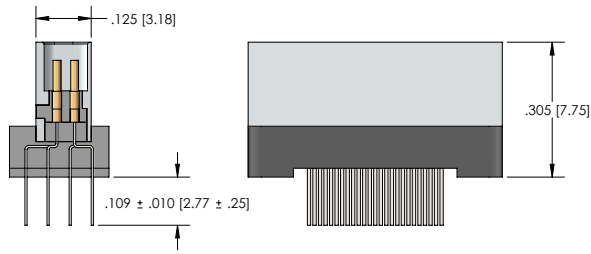
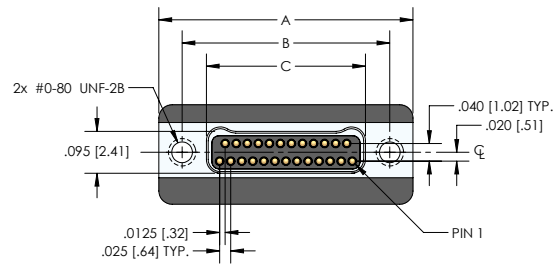
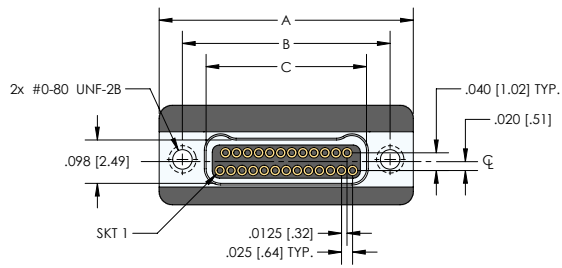

RECEPTACLE (SOCKETS)

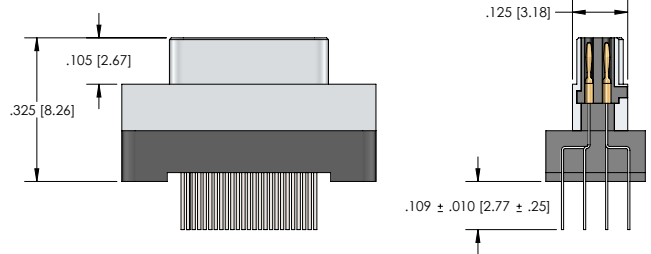

PLUG (PINS)

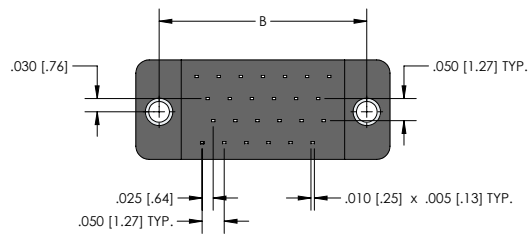
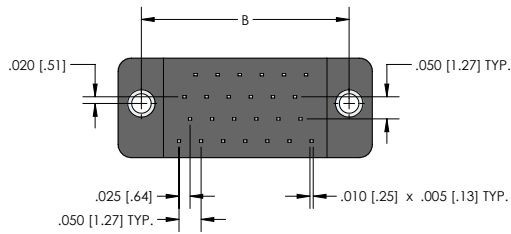

CNM6 SERIES					
Size	A	B	Plug C	Receptacle	D
9	.375 [9.52]	.270 [6.86]	.160 [4.06]	.163 [4.14]	.175 [4.44]
15	.450 [11.43]	.345 [8.76]	.235 [5.97]	.238 [6.04]	.250 [6.35]
21	.525 [13.33]	.420 [10.67]	.310 [7.87]	.313 [7.95]	.325 [8.25]
25	.575 [14.60]	.470 [11.94]	.360 [9.14]	.363 [9.22]	.375 [9.52]
31	.650 [16.51]	.545 [13.84]	.435 [11.05]	.438 [11.12]	.450 [11.43]
37	.725 [18.41]	.620 [15.75]	.510 [12.95]	.513 [13.03]	.525 [13.33]
51	.900 [22.86]	.795 [20.19]	.685 [17.40]	.688 [17.47]	.700 [17.78]
65	1.075 [27.30]	.970 [24.64]	.860 [21.84]	.863 [21.92]	.875 [22.22]

CIRCUIT CONNECTOR VERTICAL PCB LAYOUT

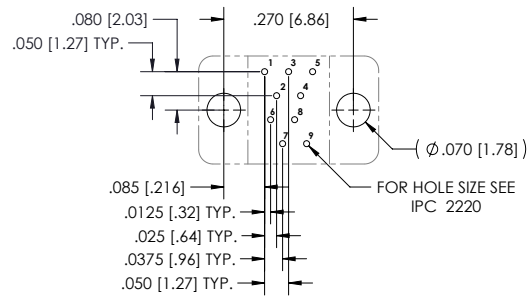
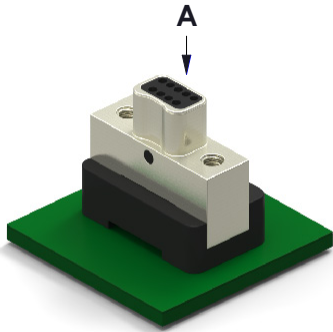

SIZE 9 - VIEW A

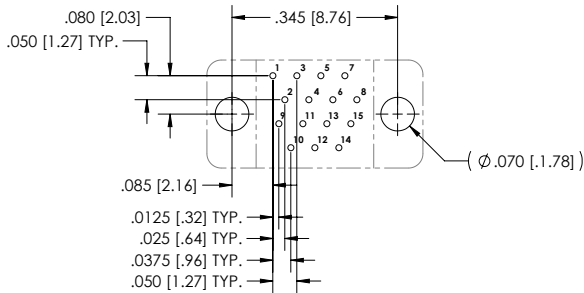

SIZE 15 - VIEW A

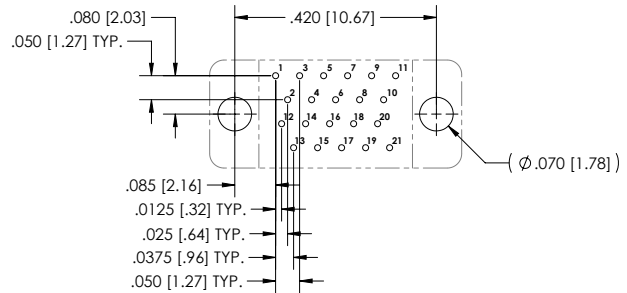

SIZE 21 - VIEW A

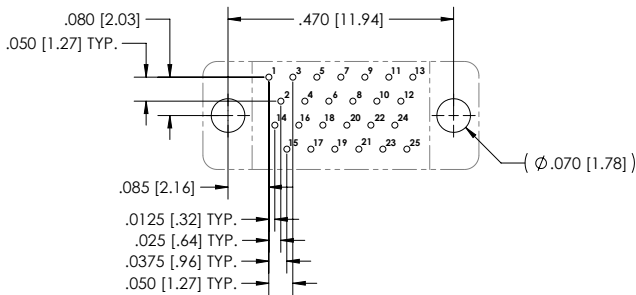

SIZE 25 - VIEW A

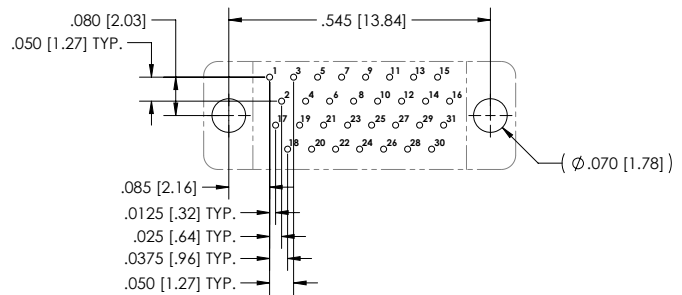

SIZE 31 - VIEW A

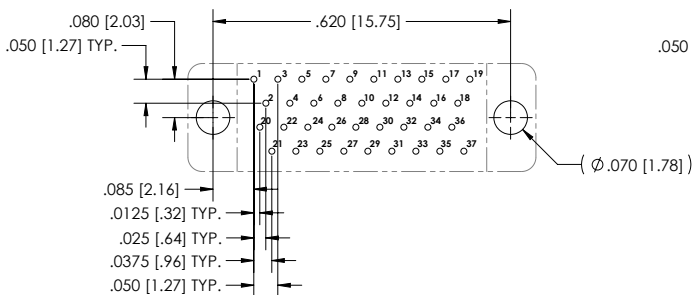

SIZE 37 - VIEW A

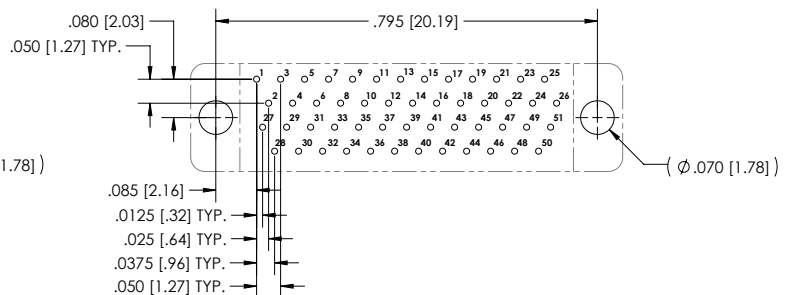

SIZE 51 - VIEW A

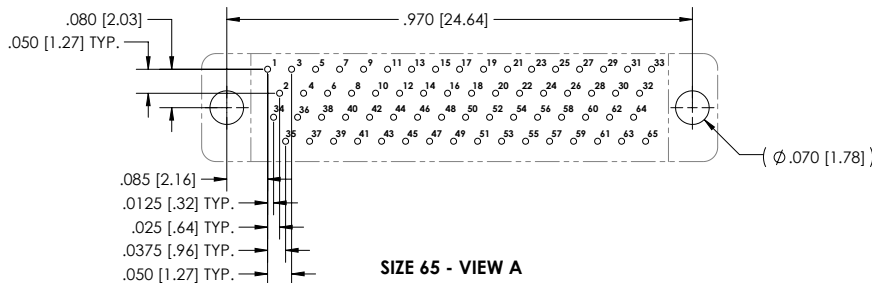

SIZE 65 - VIEW A

CIRCUIT CONNECTOR VERTICAL PCB LAYOUT

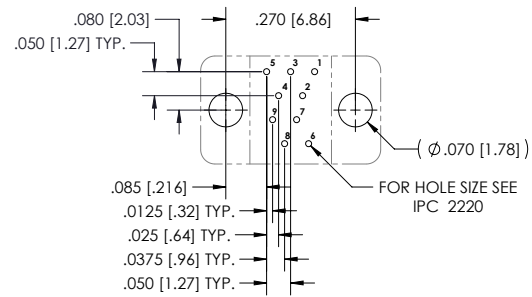
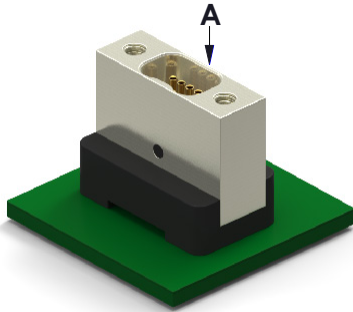

SIZE 9 - VIEW A

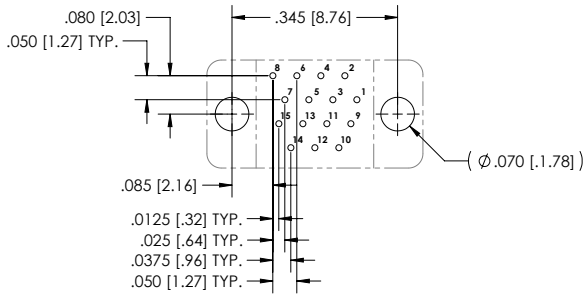

SIZE 15 - VIEW A

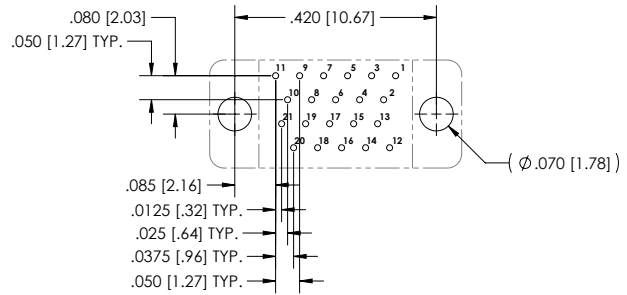

SIZE 21 - VIEW A

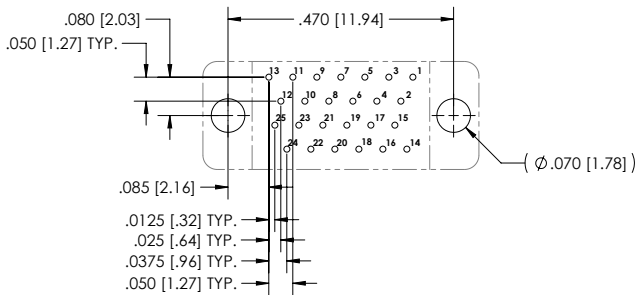

SIZE 25 - VIEW A

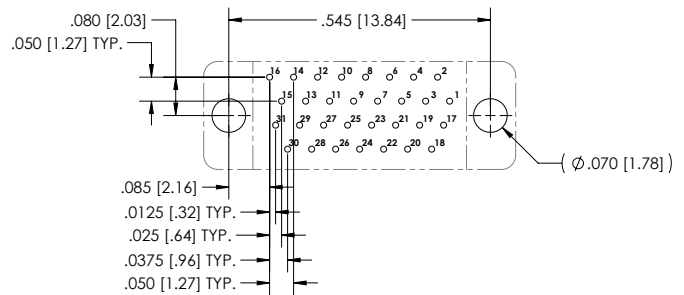

SIZE 31 - VIEW A

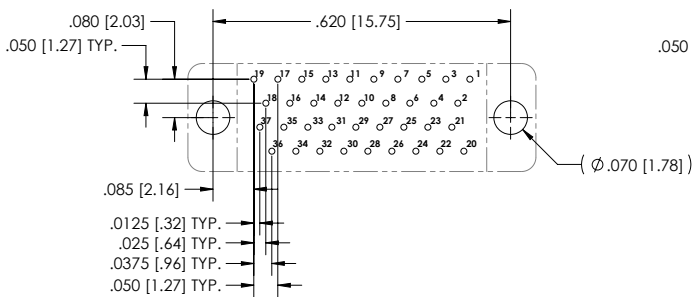

SIZE 37 - VIEW A

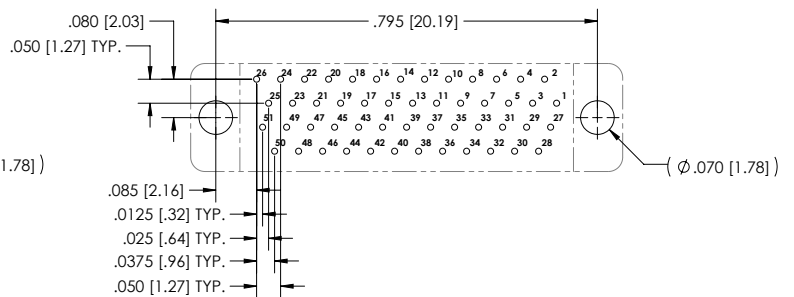

SIZE 51 - VIEW A

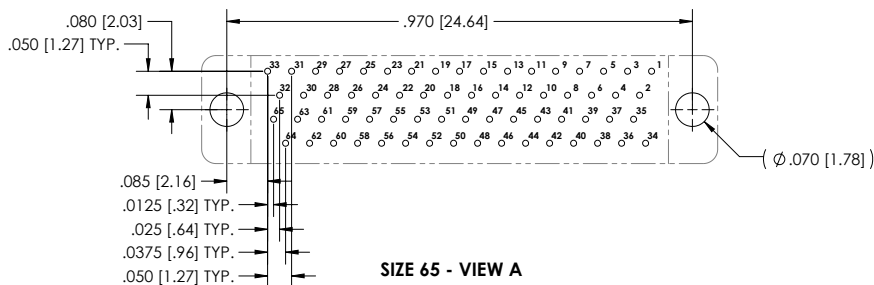

SIZE 65 - VIEW A

CIRCUIT CONNECTOR VERTICAL

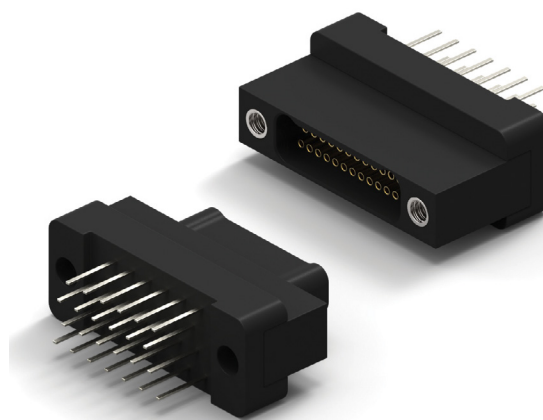

- Plastic Shell Connector
- Plated Thru Hole .050 x .050 (Style 6)
- 1 Piece Contact
- Flat Tail Termination
- Operating Temperature -50° C to 200° C
- 9 to 65 Contacts



NANO D – PID 142

HOW TO ORDER

* Indicates preferred standard

CN	P	6	L	25	-2	P	Ø7	1	
Series	Style	Insulator	Contacts	Insulator Type	Contact Gender	Hardware	Color Code	Temp Range	
CN=Nano	P=Plastic	Style=6	L=LCP	Ø9	2= Dual Row	P=Male/Pin (Plug Side)	Ø7=Threaded Hole	1= Tin plated (6Ø/4Ø)	*blank = 125C
				15				2= Gold plated (RoHS)	HT = 200C
				21		S=Female/Socket (Receptacle Side)			
				25					
				31					
				37					
				51					
				65					

ELECTRICAL PERFORMANCE DATA	Go to Page 29 See chart 133 E or Click Here for Electrical Performance Data
MECHANICAL PERFORMANCE DATA	Go to Page 29 See chart 123 M or Click Here for Mechanical Performance Data
MATERIALS DATA	Go to Page 29 See chart 142 M&F or Click Here for Materials and Finishes Data

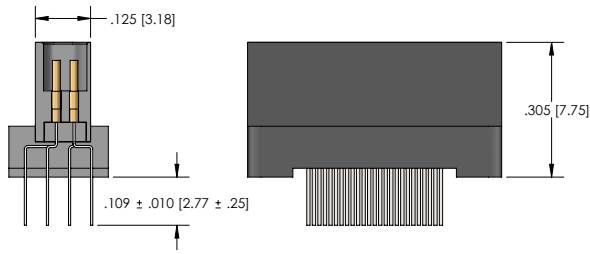
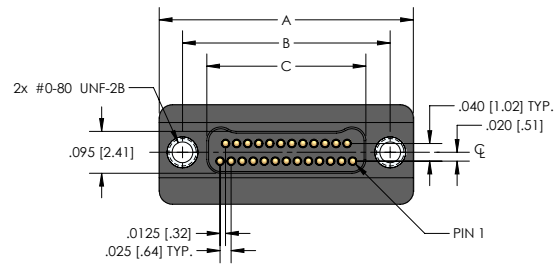
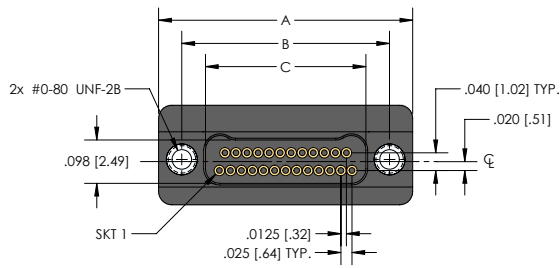

RECEPTACLE (SOCKETS)

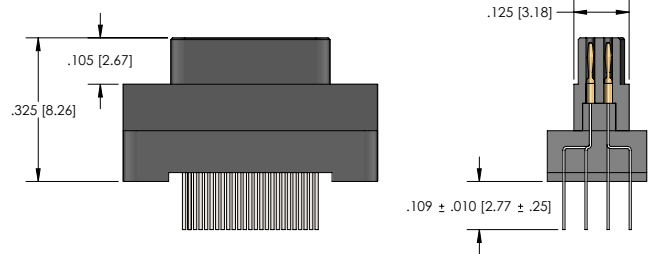

PLUG (PINS)

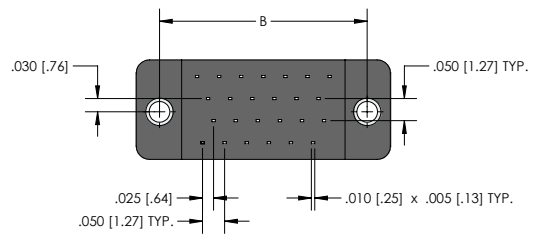
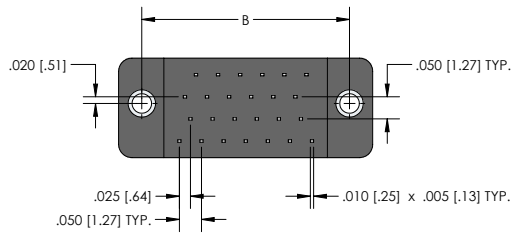

CNP6 SERIES					
Size	A	B	Plug C	Receptacle	D
9	.375 [9.52]	.270 [6.86]	.160 [4.06]	.163 [4.14]	.175 [4.44]
15	.450 [11.43]	.345 [8.76]	.235 [5.97]	.238 [6.04]	.250 [6.35]
21	.525 [13.33]	.420 [10.67]	.310 [7.87]	.313 [7.95]	.325 [8.25]
25	.575 [14.60]	.470 [11.94]	.360 [9.14]	.363 [9.22]	.375 [9.52]
31	.650 [16.51]	.545 [13.84]	.435 [11.05]	.438 [11.12]	.450 [11.43]
37	.725 [18.41]	.620 [15.75]	.510 [12.95]	.513 [13.03]	.525 [13.33]
51	.900 [22.86]	.795 [20.19]	.685 [17.40]	.688 [17.47]	.700 [17.78]
65	1.075 [27.30]	.970 [24.64]	.860 [21.84]	.863 [21.92]	.875 [22.22]

CIRCUIT CONNECTOR VERTICAL PCB LAYOUT

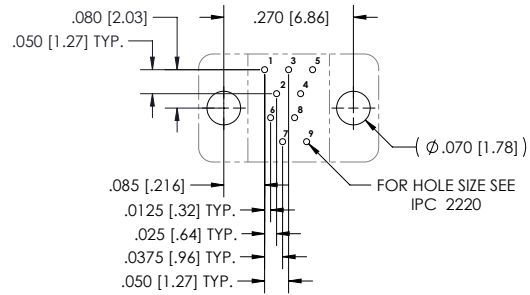
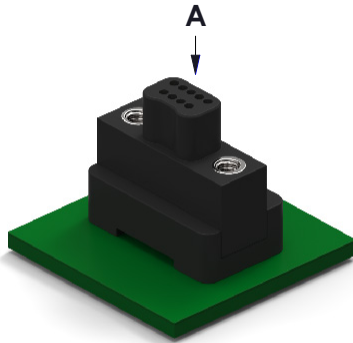

SIZE 9 - VIEW A

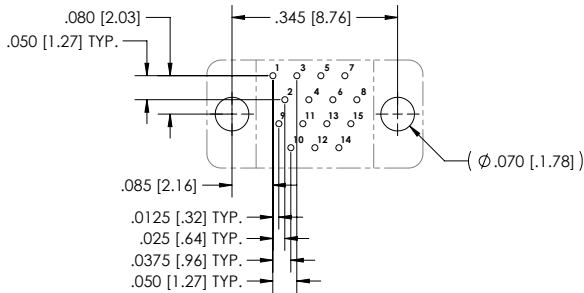

SIZE 15 - VIEW A

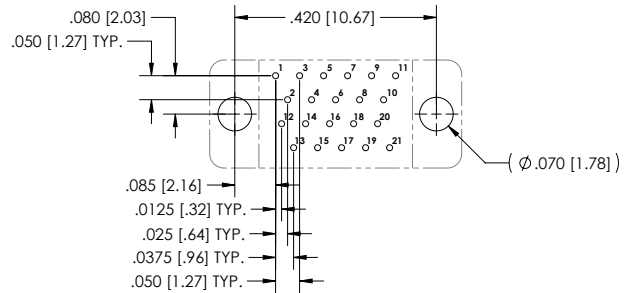

SIZE 21 - VIEW A

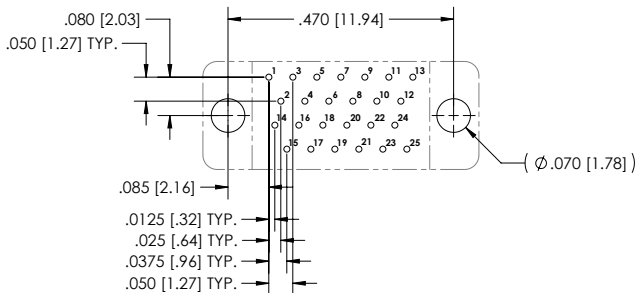

SIZE 25 - VIEW A

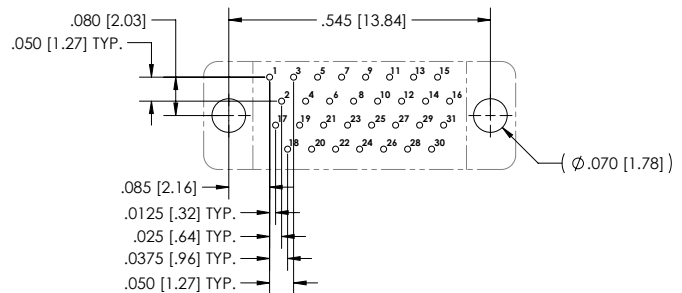

SIZE 31 - VIEW A

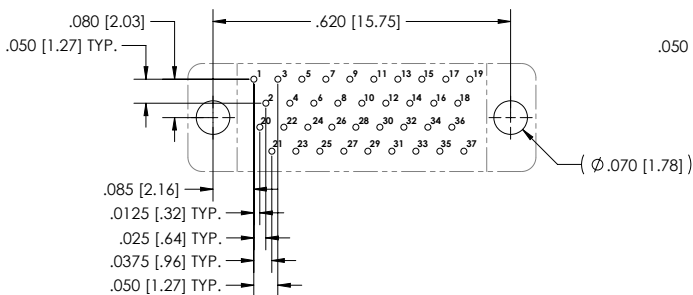

SIZE 37 - VIEW A

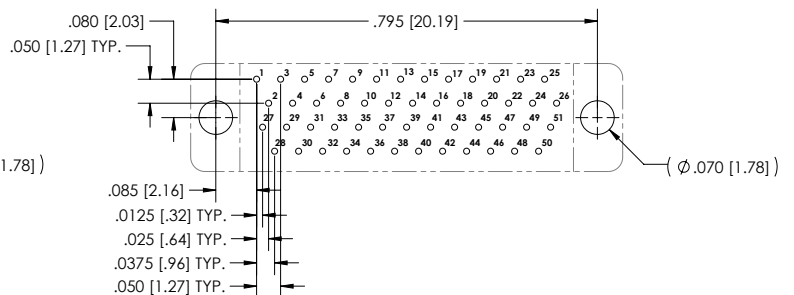

SIZE 51 - VIEW A

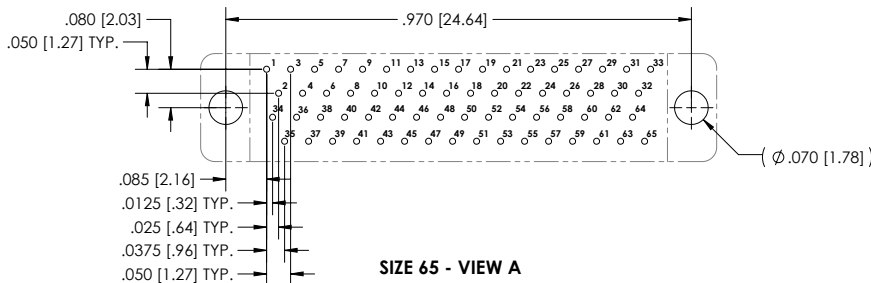

SIZE 65 - VIEW A

CIRCUIT CONNECTOR VERTICAL PCB LAYOUT

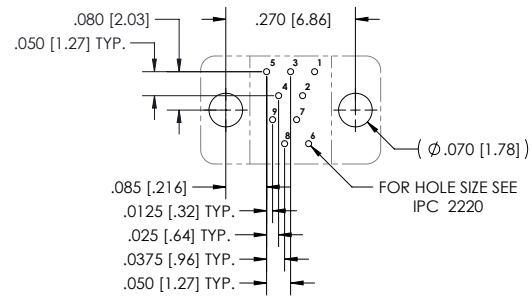
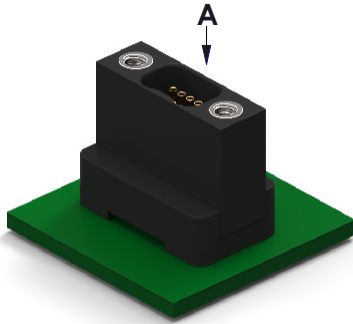

SIZE 9 - VIEW A

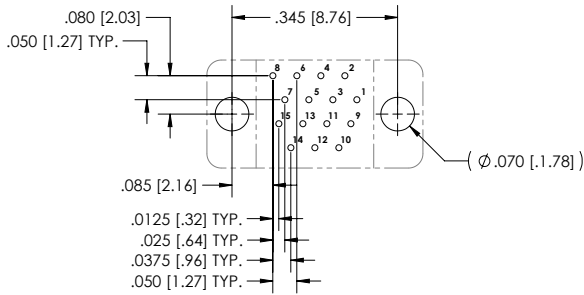

SIZE 15 - VIEW A

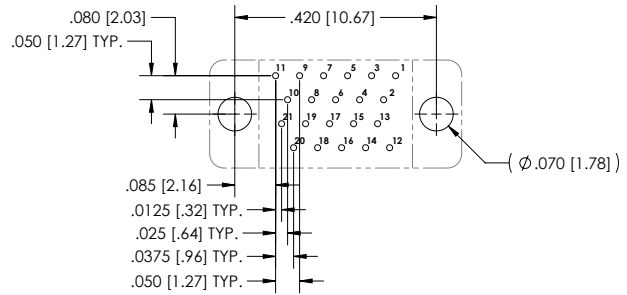

SIZE 21 - VIEW A

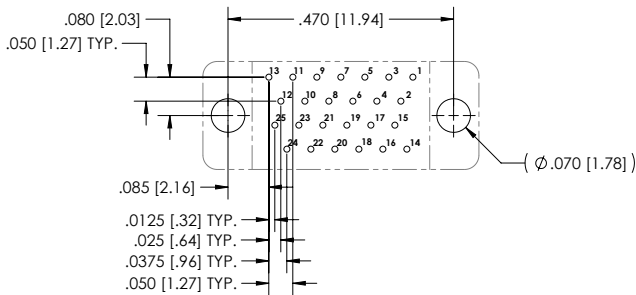

SIZE 25 - VIEW A

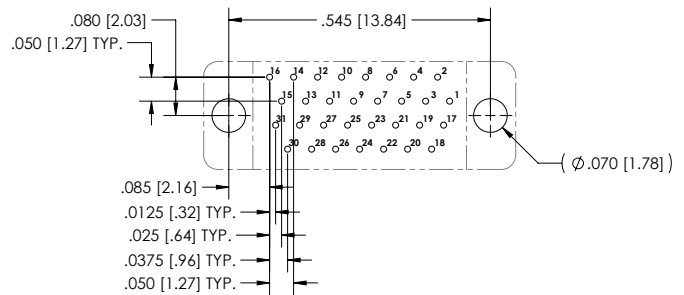

SIZE 31 - VIEW A

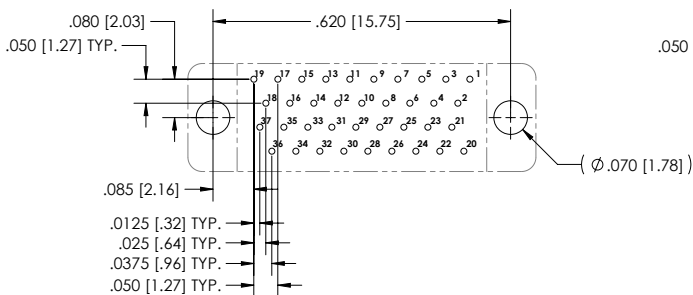

SIZE 37 - VIEW A

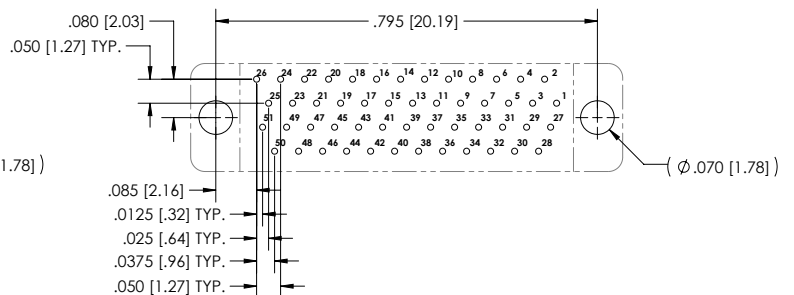

SIZE 51 - VIEW A

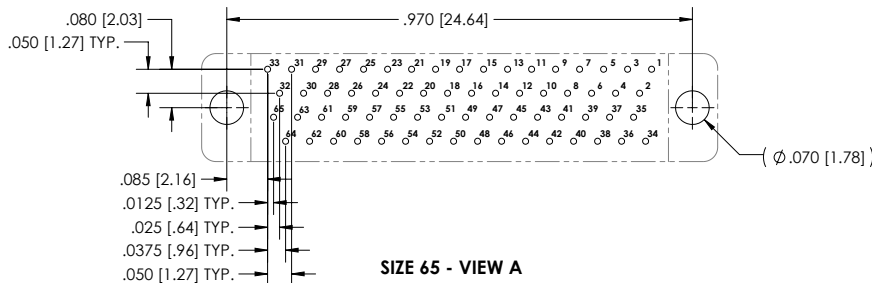

SIZE 65 - VIEW A





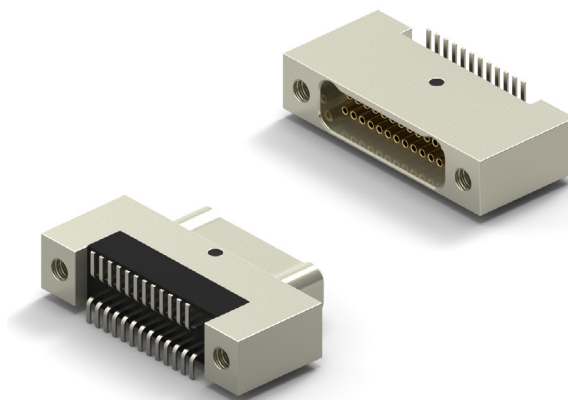



CIRCUIT CONNECTOR VERTICAL

- Metal Shell Connector
- Surface Mount .025 x .075 (Style 26)
- 1 Piece Contact
- Flat Tail Termination
- Operating Temperature -50° C to 200° C
- 9 to 65 Contacts



HOW TO ORDER

* Indicates preferred standard ** Consult factory for other plating options

CN	M	26	L	25	-2	P	Ø7	1	-SØ1	Temp Range
Series	Style	Insulator	Contacts	Insulator Type	Contact Gender	Hardware	Color Code	Finish**		
CN=Nano	M= Metal Shell	STYLE=26	L=LCP	Ø9	2= Dual Row	P=Male/Pin (Plug Side)	Ø7=Threaded Hole	1= Tin plated (60/40)	Blank= Cadmium	*blank = 125C
				15				2= Gold plated (RoHS)		HT = 200C
				21		S=Female/Socket (Receptacle Side)			*SØ1= Nickel	
				25						
				31					SØ3 = Black Anodize	
				37						
				51					SØ6 = Olive-Drab Cadmium	
				65						
									SØ7 = Titanium	
										
									SØ9 = Stainless	
										

ELECTRICAL PERFORMANCE DATA	Go to Page 29 See chart 133 E or Click Here for Electrical Performance Data
MECHANICAL PERFORMANCE DATA	Go to Page 29 See chart 123 M or Click Here for Mechanical Performance Data
MATERIALS DATA	Go to Page 29 See chart 139 M&F or Click Here for Materials and Finishes Data

DIMENSIONS

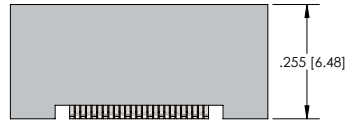
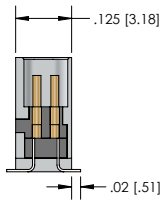
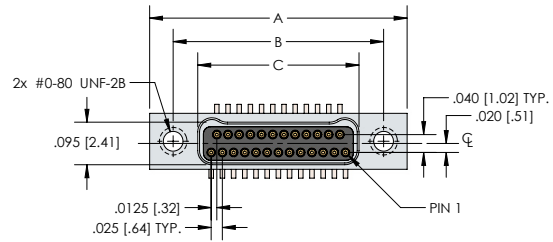
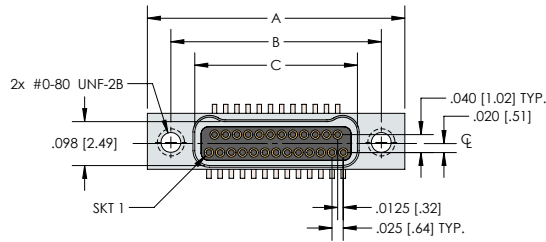

RECEPTACLE (SOCKETS)

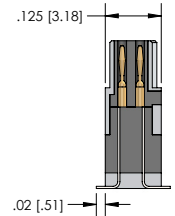
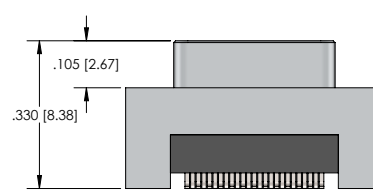

PLUG (PINS)

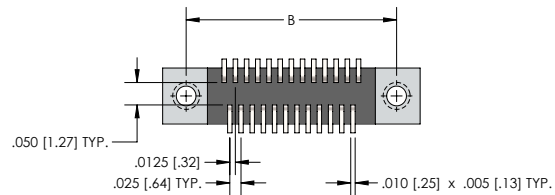
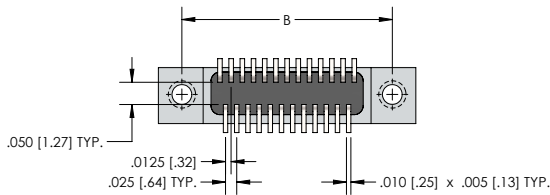

Size	CNM26 SERIES							
	A	B	Plug	C	Receptacle	D	E	F
9	.375 [9.52]	.270 [6.86]	.160 [4.06]		.163 [4.14]	.175 [4.44]	.100 [2.54]	.075 [1.90]
15	.450 [11.43]	.345 [8.76]	.235 [5.97]		.238 [6.04]	.250 [6.35]	.175 [4.44]	.150 [3.81]
21	.525 [13.33]	.420 [10.67]	.310 [7.87]		.313 [7.95]	.325 [8.25]	.250 [6.35]	.225 [5.71]
25	.575 [14.60]	.470 [11.94]	.360 [9.14]		.363 [9.22]	.375 [9.52]	.300 [7.62]	.275 [6.98]
31	.650 [16.51]	.545 [13.84]	.435 [11.05]		.438 [11.12]	.450 [11.43]	.375 [9.52]	.350 [8.89]
37	.725 [18.41]	.620 [15.75]	.510 [12.95]		.513 [13.03]	.525 [13.33]	.450 [11.43]	.425 [10.79]
51	.900 [22.86]	.795 [20.19]	.685 [17.40]		.688 [17.47]	.700 [17.78]	.625 [15.87]	.600 [15.24]
65	1.075 [27.30]	.970 [24.64]	.860 [21.84]		.863 [21.92]	.875 [22.22]	.800 [20.32]	.775 [19.68]

CIRCUIT CONNECTOR VERTICAL PCB LAYOUT

NANO D – PID 143

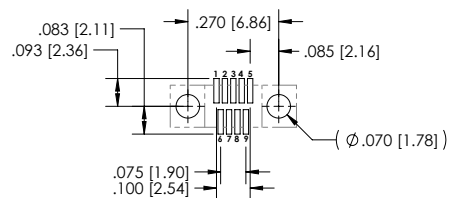
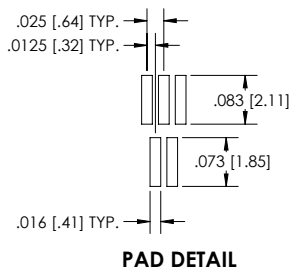
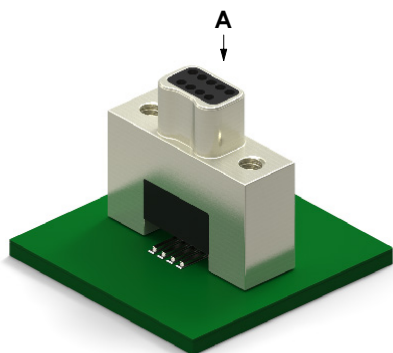

SIZE 9 - VIEW A

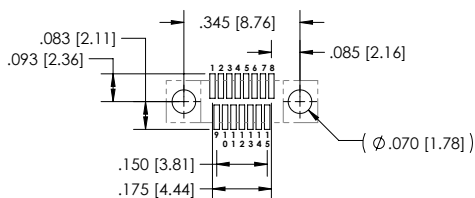

SIZE 15 - VIEW A

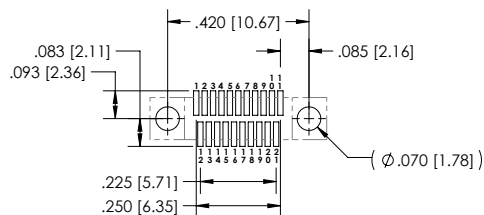

SIZE 21 - VIEW A

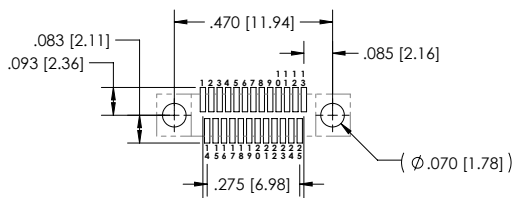

SIZE 25 - VIEW A

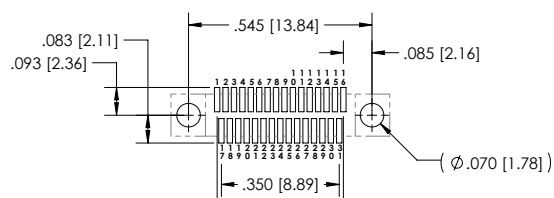

SIZE 31 - VIEW A

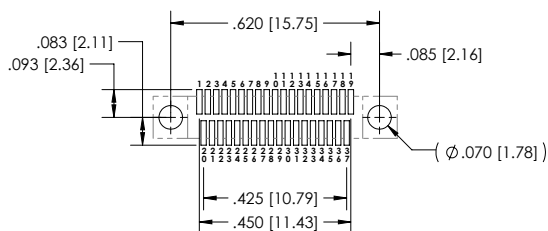

SIZE 37 - VIEW A

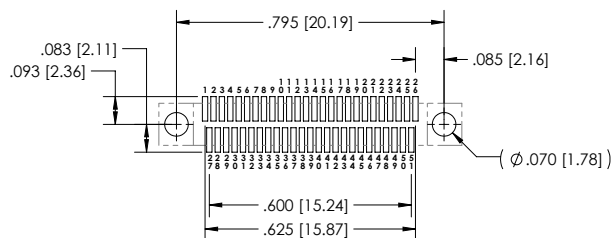

SIZE 51 - VIEW A

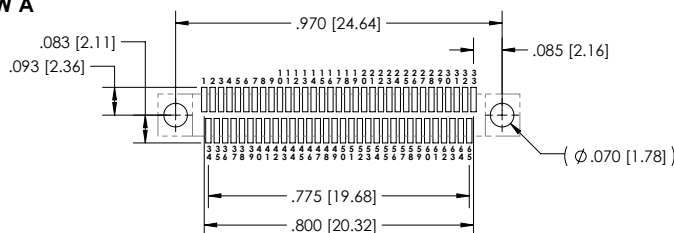

SIZE 65 - VIEW A

CIRCUIT CONNECTOR VERTICAL PCB LAYOUT

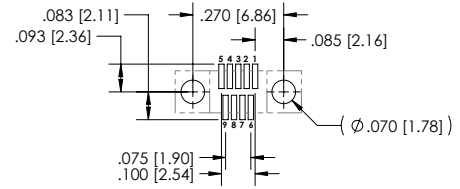
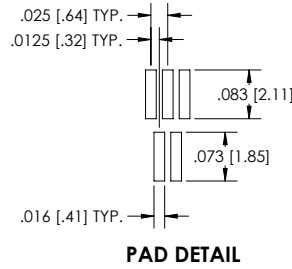
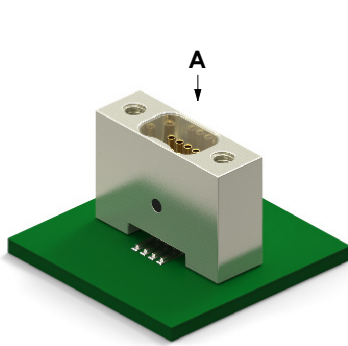

SIZE 9 - VIEW A

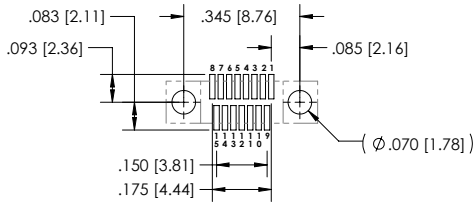

SIZE 15 - VIEW A

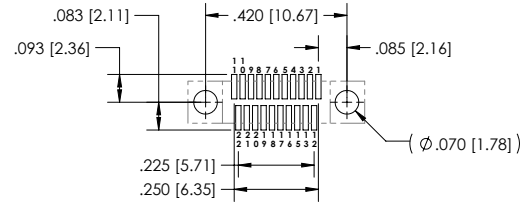

SIZE 21 - VIEW A

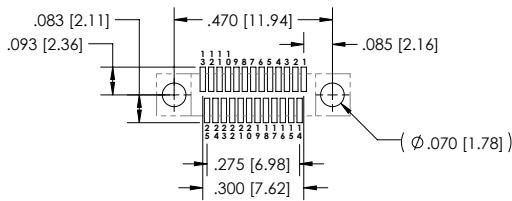

SIZE 25 - VIEW A

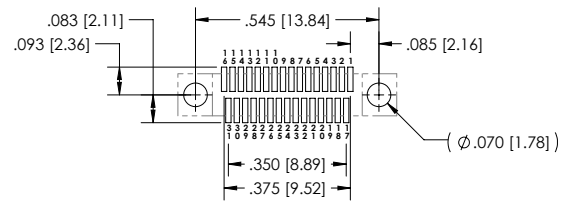

SIZE 31 - VIEW A

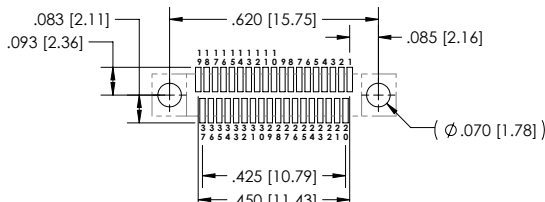

SIZE 37 - VIEW A

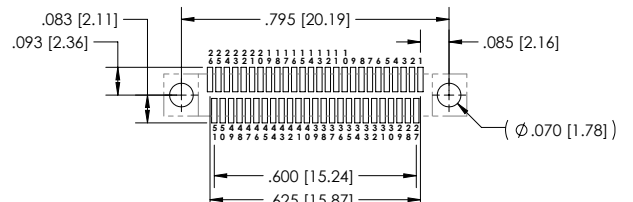

SIZE 51 - VIEW A

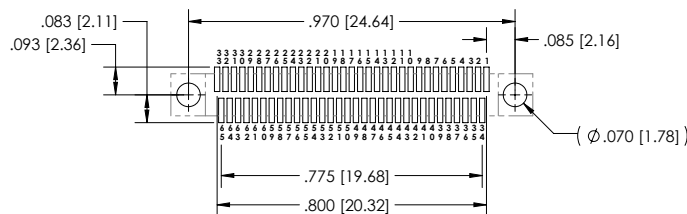

SIZE 65 - VIEW A

CIRCUIT CONNECTOR VERTICAL

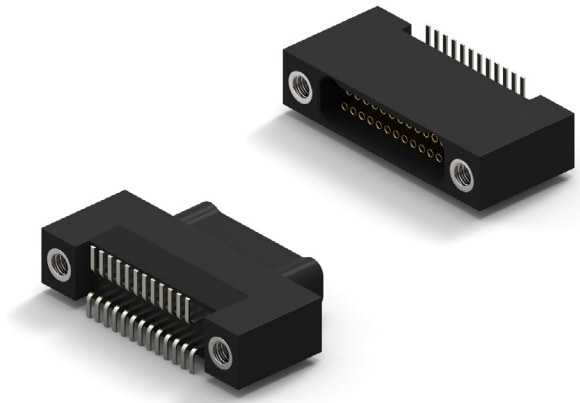

- Plastic Shell Connector
- Surface Mount .025 x .075 (Style 26)
- 1 Piece Contact
- Flat Tail Termination
- Operating Temperature -50° C to 200° C
- 9 to 65 Contacts



NANO D – PID 144

HOW TO ORDER

* Indicates preferred standard

CN	P	26	L	25	-2	P	Ø7	1	
Series	Style	Insulator	Contacts	Insulator Type	Contact Gender	Hardware	Color Code	Temp Range	
CN=Nano	P=Plastic	Style=26	L=LCP	Ø9	2= Dual Row	P=Male/Pin (Plug Side)	Ø7=Threaded Hole	1= Tin plated (6Ø/4Ø)	*blank = 125C
				15				2= Gold plated (RoHS)	HT = 200C
				21		S=Female/Socket (Receptacle Side)			
				25					
				31					
				37					
				51					
				65					

ELECTRICAL PERFORMANCE DATA	Go to Page 29 See chart 133 E or Click Here for Electrical Performance Data
MECHANICAL PERFORMANCE DATA	Go to Page 29 See chart 123 M or Click Here for Mechanical Performance Data
MATERIALS DATA	Go to Page 29 See chart 142 M&F or Click Here for Materials and Finishes Data

DIMENSIONS

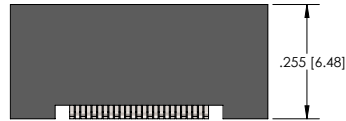
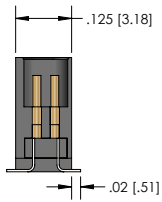
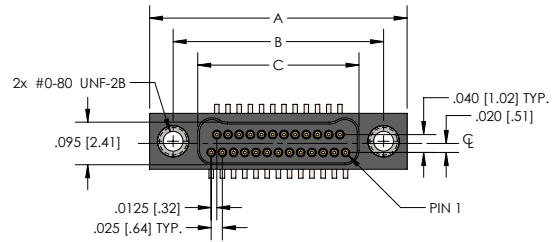
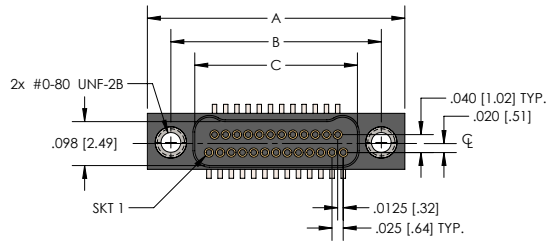

RECEPTACLE (SOCKETS)

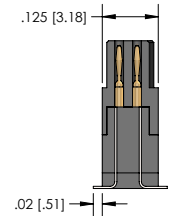
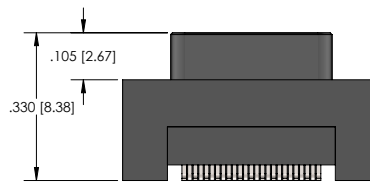

PLUG (PINS)

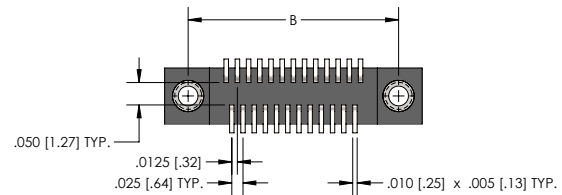
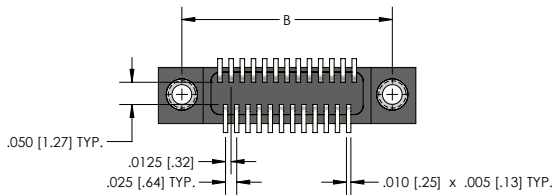

CNP26 SERIES								
Size	A	B	Plug	C	Receptacle	D	E	F
9	.375 [9.52]	.270 [6.86]	.160 [4.06]		.163 [4.14]	.175 [4.44]	.100 [2.54]	.075 [1.90]
15	.450 [11.43]	.345 [8.76]	.235 [5.97]		.238 [6.04]	.250 [6.35]	.175 [4.44]	.150 [3.81]
21	.525 [13.33]	.420 [10.67]	.310 [7.87]		.313 [7.95]	.325 [8.25]	.250 [6.35]	.225 [5.71]
25	.575 [14.60]	.470 [11.94]	.360 [9.14]		.363 [9.22]	.375 [9.52]	.300 [7.62]	.275 [6.98]
31	.650 [16.51]	.545 [13.84]	.435 [11.05]		.438 [11.12]	.450 [11.43]	.375 [9.52]	.350 [8.89]
37	.725 [18.41]	.620 [15.75]	.510 [12.95]		.513 [13.03]	.525 [13.33]	.450 [11.43]	.425 [10.79]
51	.900 [22.86]	.795 [20.19]	.685 [17.40]		.688 [17.47]	.700 [17.78]	.625 [15.87]	.600 [15.24]
65	1.075 [27.30]	.970 [24.64]	.860 [21.84]		.863 [21.92]	.875 [22.22]	.800 [20.32]	.775 [19.68]

CIRCUIT CONNECTOR VERTICAL PCB LAYOUT

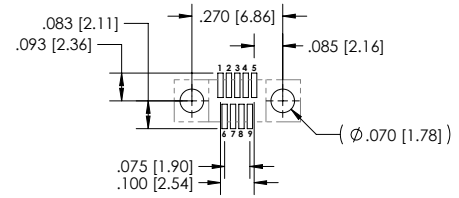
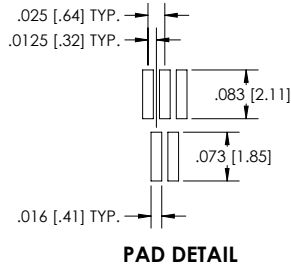
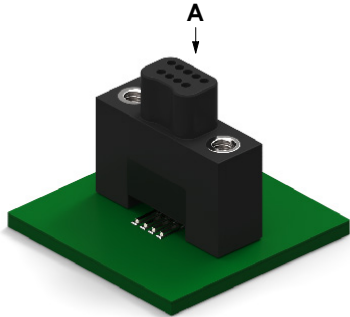

SIZE 9 - VIEW A

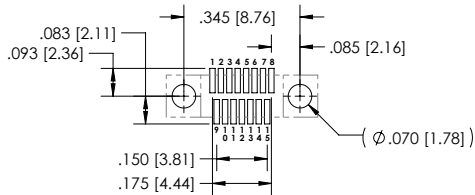

SIZE 15 - VIEW A

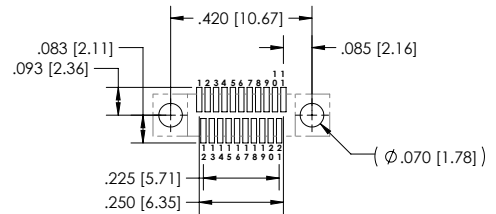

SIZE 21 - VIEW A

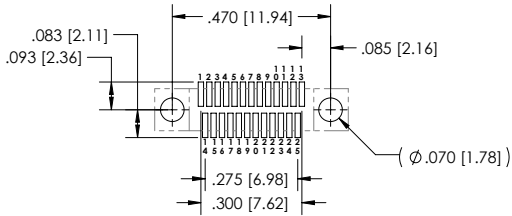

SIZE 25 - VIEW A

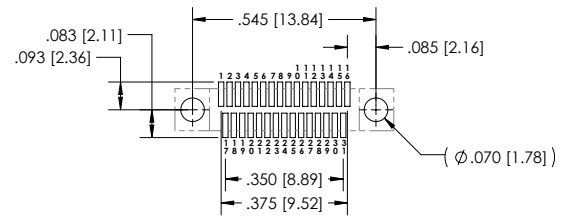

SIZE 31 - VIEW A

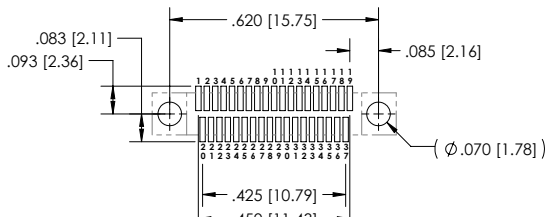

SIZE 37 - VIEW A

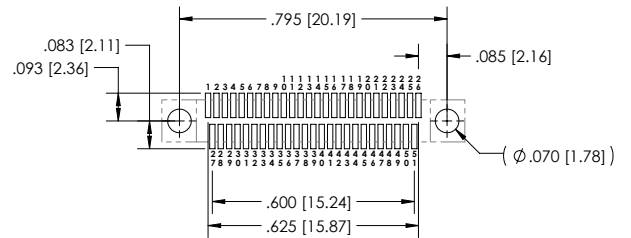

SIZE 51 - VIEW A

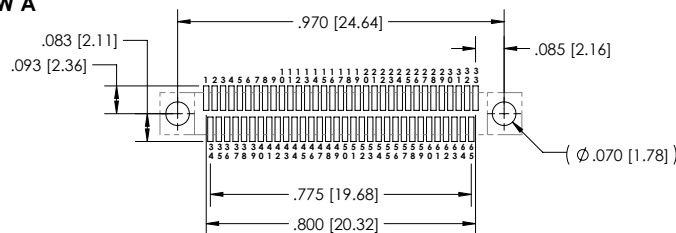

SIZE 65 - VIEW A

CIRCUIT CONNECTOR VERTICAL PCB LAYOUT

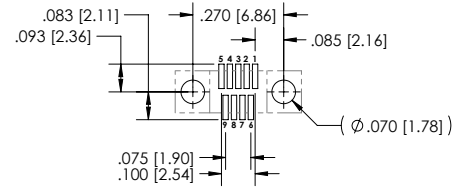
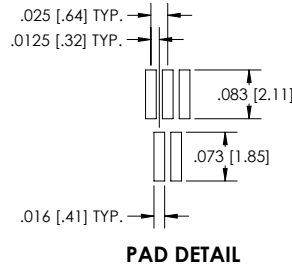
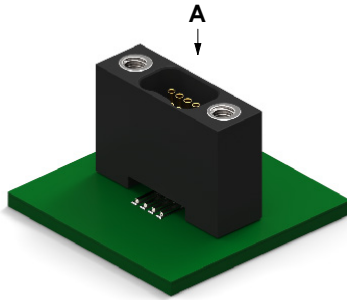

SIZE 9 - VIEW A

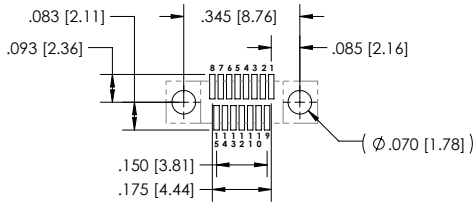

SIZE 15 - VIEW A

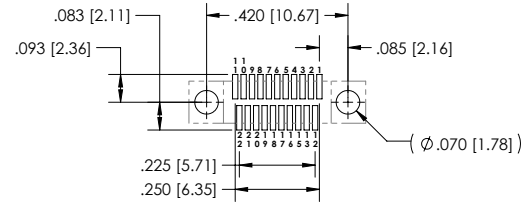

SIZE 21 - VIEW A

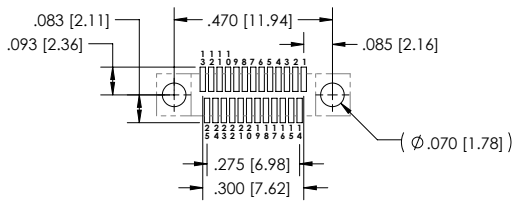

SIZE 25 - VIEW A

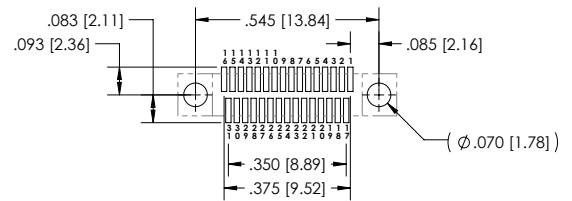

SIZE 31 - VIEW A

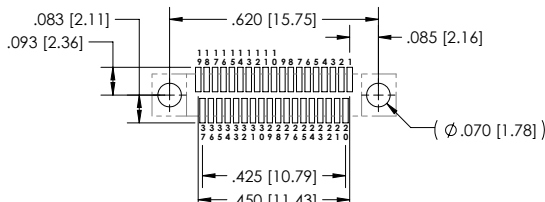

SIZE 37 - VIEW A

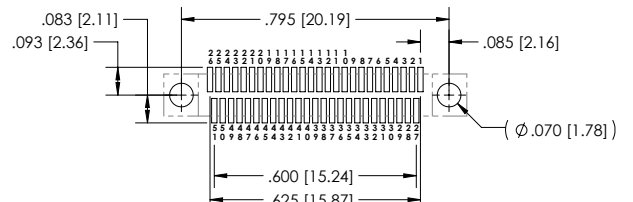

SIZE 51 - VIEW A

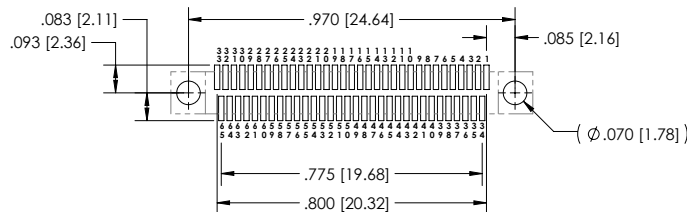

SIZE 65 - VIEW A





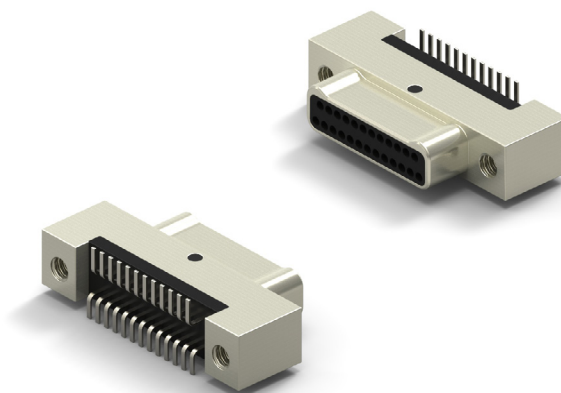



CIRCUIT CONNECTOR VERTICAL

- Metal Shell Low Profile Male Connector
- Surface Mount .025 x .075 (Style 36)
- 1 Piece Contact
- Flat Tail Termination
- Operating Temperature -50° C to 200° C
- 9 to 65 Contacts



HOW TO ORDER

* Indicates preferred standard ** Consult factory for other plating options

CN	M	36	L	25	-2	P	Ø7	1	-SØ1	Temp Range
Series	Style	Insulator	Contacts	Insulator Type	Contact Gender	Hardware	Color Code	Finish**		
CN= Nano	M= Metal Shell	STYLE=36	L=LCP	Ø9	2= Dual Row	P= Male/Pin (Plug Side)	Ø7= Threaded Hole	1= Tin plated (6Ø/4Ø)	Blank= Cadmium	*blank = 125C
				15				2= Gold plated (RoHS)		HT = 200C
				21					*SØ1= Nickel	
				25						
				31					SØ3 = Black Anodize	
				37						
				51					SØ6 = Olive-Drab Cadmium	
				65						
									SØ7 = Titanium	
										
									SØ9 = Stainless	
										

ELECTRICAL PERFORMANCE DATA	Go to Page 29 See chart 133 E or Click Here for Electrical Performance Data
MECHANICAL PERFORMANCE DATA	Go to Page 29 See chart 123 M or Click Here for Mechanical Performance Data
MATERIALS DATA	Go to Page 29 See chart 145 M&F or Click Here for Materials and Finishes Data

DIMENSIONS

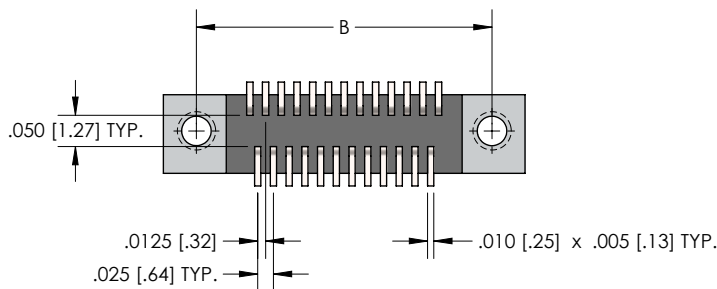
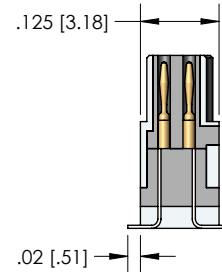
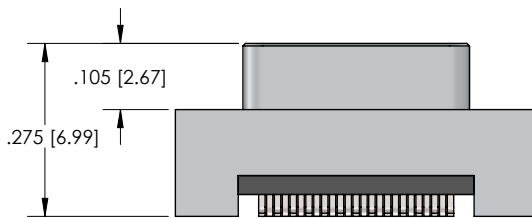
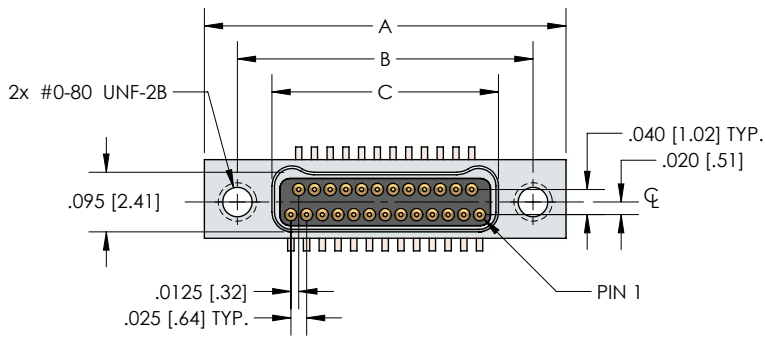

CNM36 SERIES								
Size	A	B	Plug	C	Receptacle	D	E	F
9	.375 [9.52]	.270 [6.86]	.160 [4.06]		.163 [4.14]	.175 [4.44]	.100 [2.54]	.075 [1.90]
15	.450 [11.43]	.345 [8.76]	.235 [5.97]		.238 [6.04]	.250 [6.35]	.175 [4.44]	.150 [3.81]
21	.525 [13.33]	.420 [10.67]	.310 [7.87]		.313 [7.95]	.325 [8.25]	.250 [6.35]	.225 [5.71]
25	.575 [14.60]	.470 [11.94]	.360 [9.14]		.363 [9.22]	.375 [9.52]	.300 [7.62]	.275 [6.98]
31	.650 [16.51]	.545 [13.84]	.435 [11.05]		.438 [11.12]	.450 [11.43]	.375 [9.52]	.350 [8.89]
37	.725 [18.41]	.620 [15.75]	.510 [12.95]		.513 [13.03]	.525 [13.33]	.450 [11.43]	.425 [10.79]
51	.900 [22.86]	.795 [20.19]	.685 [17.40]		.688 [17.47]	.700 [17.78]	.625 [15.87]	.600 [15.24]
65	1.075 [27.30]	.970 [24.64]	.860 [21.84]		.863 [21.92]	.875 [22.22]	.800 [20.32]	.775 [19.68]

CIRCUIT CONNECTOR VERTICAL PCB LAYOUT

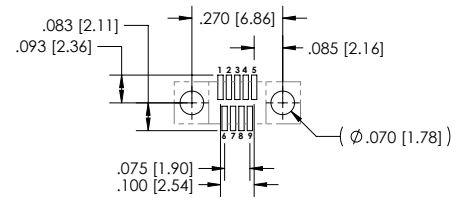
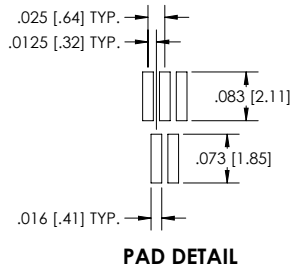
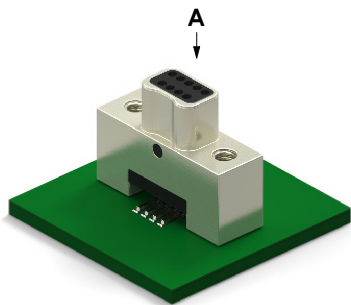

SIZE 9 - VIEW A

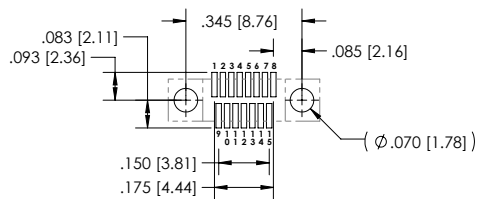

SIZE 15 - VIEW A

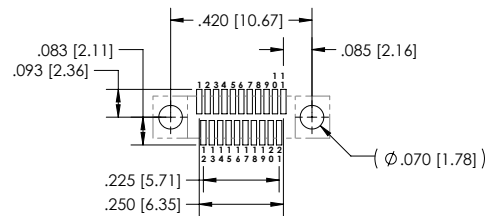

SIZE 21 - VIEW A

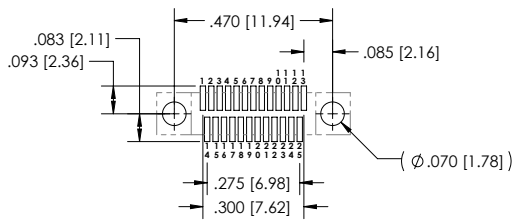

SIZE 25 - VIEW A

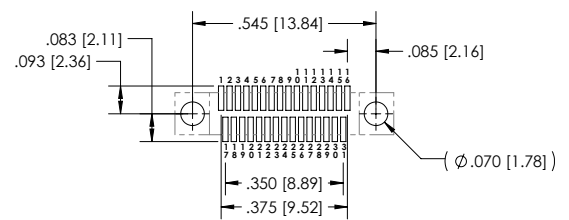

SIZE 31 - VIEW A

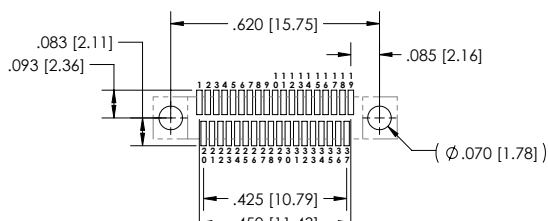

SIZE 37 - VIEW A

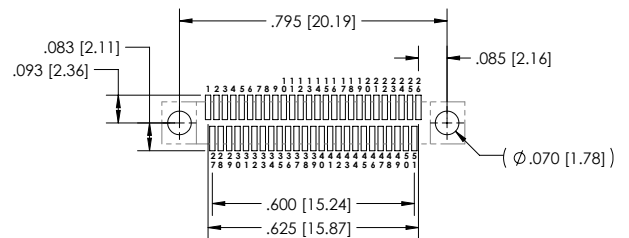

SIZE 51 - VIEW A

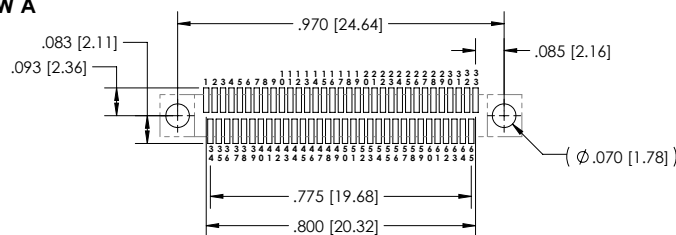

SIZE 65 - VIEW A

THIS PAGE LEFT
INTENTIONALLY BLANK

CIRCUIT CONNECTOR VERTICAL

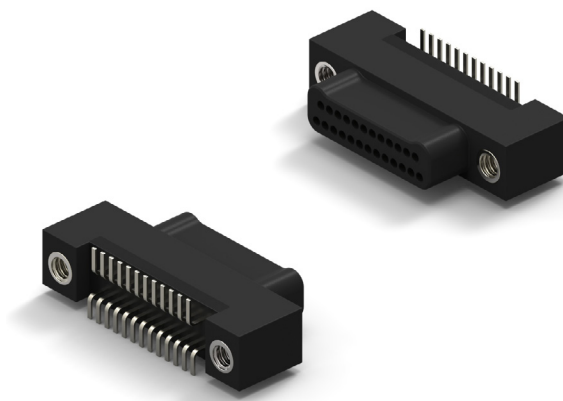

- Plastic Shell Low Profile Male Connector
- Surface Mount .025 x .075 (Style 36)
- 1 Piece Contact
- Flat Tail Termination
- Operating Temperature -50° C to 200° C
- 9 to 65 Contacts



NANO D – PID 146

HOW TO ORDER

* Indicates preferred standard

CN	P	36	L	25	-2	P	Ø7	1	
Series	Style	Insulator	Contacts	Insulator Type	Contact Gender	Hardware	Color Code	Temp Range	
CN=Nano	P=Plastic	Style=36	L=LCP	Ø9	2= Dual Row	P=Male/Pin (Plug Side)	Ø7=Threaded Hole	1= Tin plated (6Ø/4Ø)	*blank = 125C
				15				2= Gold plated (RoHS)	HT = 200C
				21					
				25					
				31					
				37					
				51					
				65					

ELECTRICAL PERFORMANCE DATA	Go to Page 29 See chart 133 E or Click Here for Electrical Performance Data
MECHANICAL PERFORMANCE DATA	Go to Page 29 See chart 123 M or Click Here for Mechanical Performance Data
MATERIALS DATA	Go to Page 29 See chart 146 M&F or Click Here for Materials and Finishes Data

DIMENSIONS

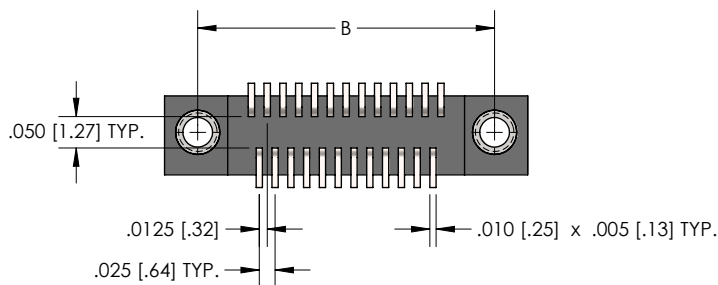
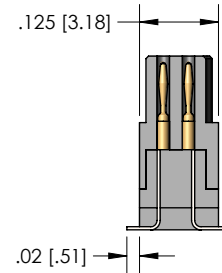
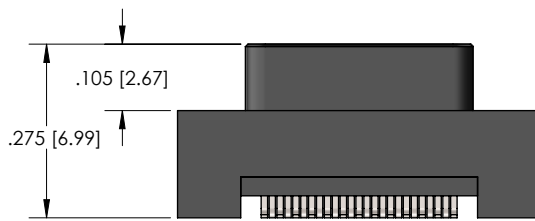
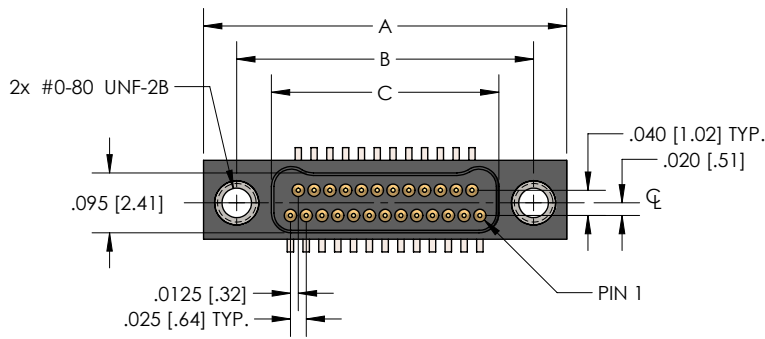

CNP36 SERIES								
Size	A	B	Plug	C	Receptacle	D	E	F
9	.375 [9.52]	.270 [6.86]	.160 [4.06]		.163 [4.14]	.175 [4.44]	.100 [2.54]	.075 [1.90]
15	.450 [11.43]	.345 [8.76]	.235 [5.97]		.238 [6.04]	.250 [6.35]	.175 [4.44]	.150 [3.81]
21	.525 [13.33]	.420 [10.67]	.310 [7.87]		.313 [7.95]	.325 [8.25]	.250 [6.35]	.225 [5.71]
25	.575 [14.60]	.470 [11.94]	.360 [9.14]		.363 [9.22]	.375 [9.52]	.300 [7.62]	.275 [6.98]
31	.650 [16.51]	.545 [13.84]	.435 [11.05]		.438 [11.12]	.450 [11.43]	.375 [9.52]	.350 [8.89]
37	.725 [18.41]	.620 [15.75]	.510 [12.95]		.513 [13.03]	.525 [13.33]	.450 [11.43]	.425 [10.79]
51	.900 [22.86]	.795 [20.19]	.685 [17.40]		.688 [17.47]	.700 [17.78]	.625 [15.87]	.600 [15.24]
65	1.075 [27.30]	.970 [24.64]	.860 [21.84]		.863 [21.92]	.875 [22.22]	.800 [20.32]	.775 [19.68]

CIRCUIT CONNECTOR VERTICAL PCB LAYOUT

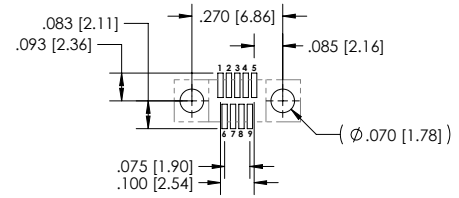
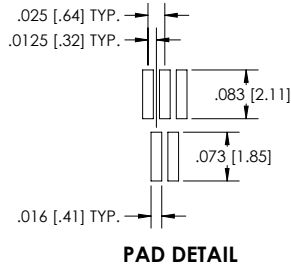
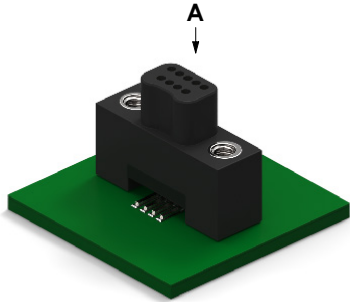

SIZE 9 - VIEW A

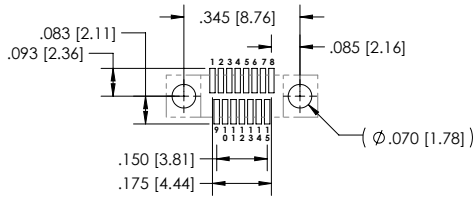

SIZE 15 - VIEW A

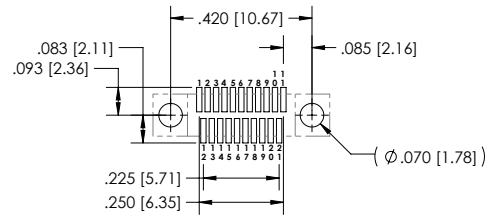

SIZE 21 - VIEW A

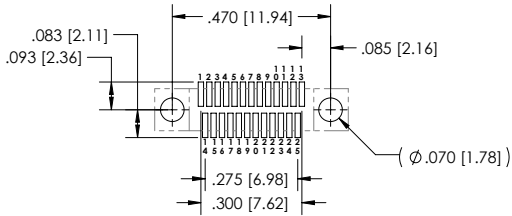

SIZE 25 - VIEW A

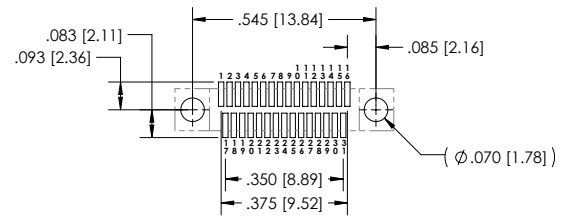

SIZE 31 - VIEW A

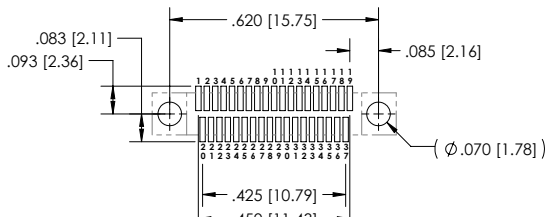

SIZE 37 - VIEW A

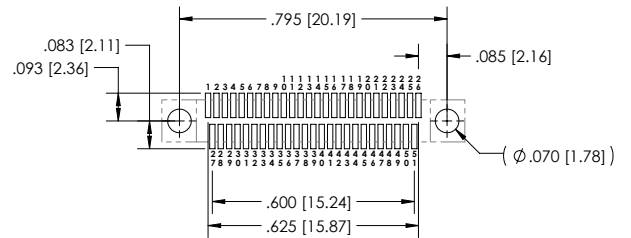

SIZE 51 - VIEW A

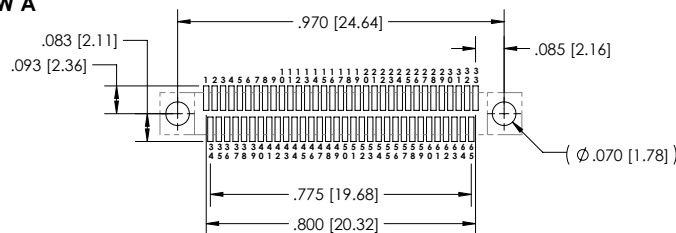

SIZE 65 - VIEW A

THIS PAGE LEFT
INTENTIONALLY BLANK





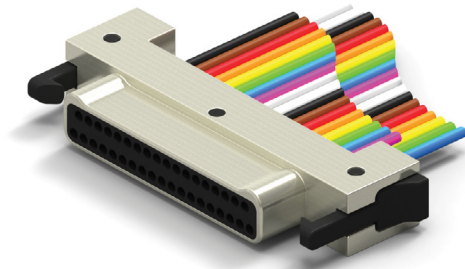

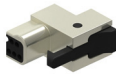

LATCHING WIRED CONNECTOR

- Metal Shell Connector w/Wire Leads
- Quick Disconnect Latch Mechanism
- Operating Temperature -50° C to 200° C
- 9 to 37 Contacts



HOW TO ORDER

* Indicates preferred standard ** Consult factory for other plating options

N	M	L	25	-	2	P	Ø4	-	30	F	6	-	18	-	SØ1	Temp Range
Series	Insulator	Contacts	Insulator Type	Contact Gender	Hardware	Wire Gauge	Wire Type	Color Code	Length	Finish**	Temp Range					
N= Nano	M= Metal	L= LCP	Ø9	2= Dual Row	P= Male/Pin (Plug Side)	Ø4= Latch	3Ø*	C= Solid Wire, uninsulated	1= White	*18.Ø	Blank= Cadmium	*blank = 125C				
			15				32	*F= Stranded, w/ Teflon insulation, per NEMA HP3-ET	3= Tin plated (6Ø/4Ø) (solid wire)	*36.Ø		HT = 2ØØC				
			21		S= Female/Socket (Receptacle Side)		34	Y= Stranded w/ Tefzel insulation, per SAE AS22759/33	4= Gold plated (RoHS) (solid wire)		*SØ1 = Nickel					
			25					X= Stranded, per DSCC Ø4Ø47-3ØA (White, 3Ø AWG only)	*6 = 10 solid colors, repeating							
			31					T= Flat Integral Tail			SØ3 = Black Anodize					
			37													
											SØ6 = Olive-Drab Cadmium					
																
											SØ7 = Titanium					
																
											SØ9 = Stainless					
																

ELECTRICAL PERFORMANCE DATA	Go to Page 30 See chart 133 E or Click Here for Electrical Performance Data
MECHANICAL PERFORMANCE DATA	Go to Page 30 See chart 123 M or Click Here for Mechanical Performance Data
MATERIALS DATA	Go to Page 30 See chart 149 M&F or Click Here for Materials and Finishes Data

NANO D – PID 149

DIMENSIONS

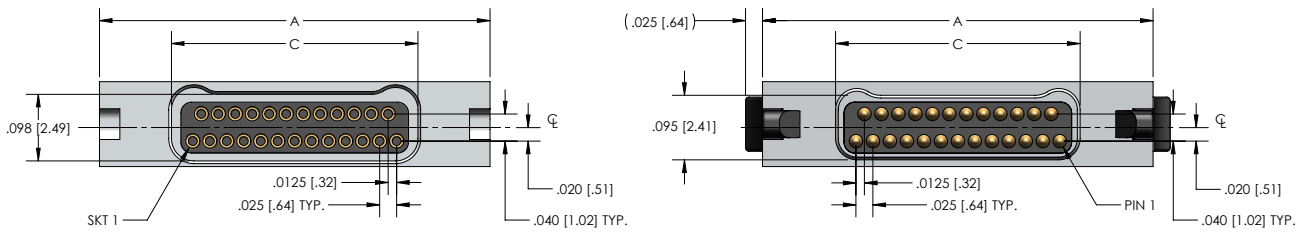
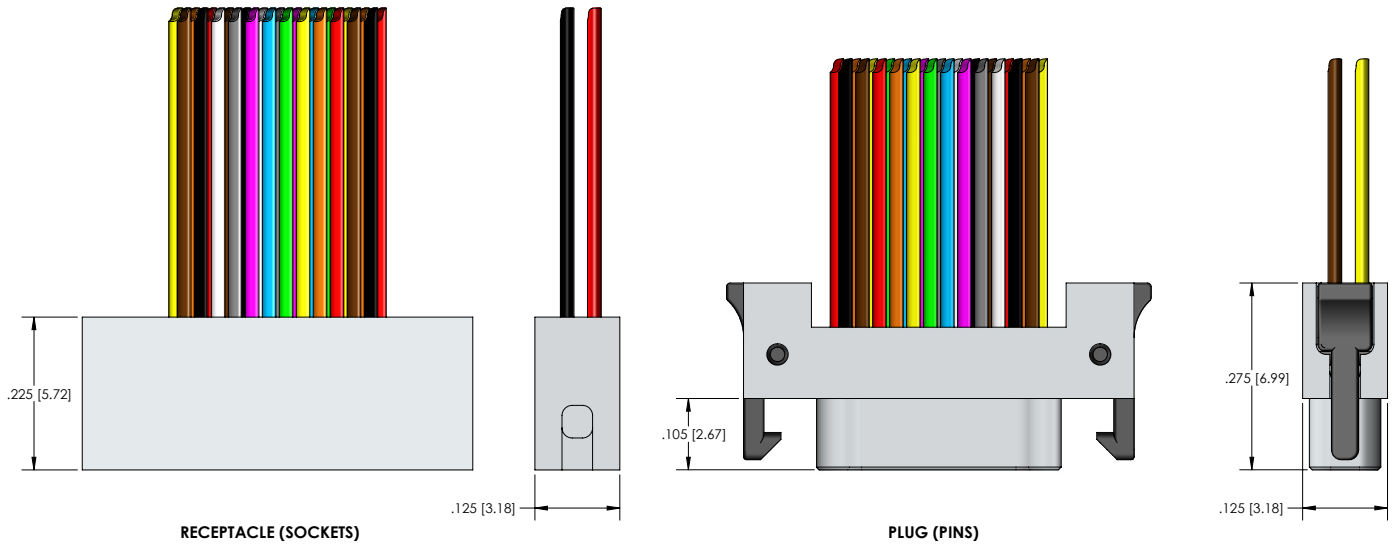

Size	NM SERIES		
	A	Plug C	Receptacle
9	.375 [9.52]	.160 [4.06]	.163 [4.14]
15	.450 [11.43]	.235 [5.97]	.238 [6.04]
21	.525 [13.33]	.310 [7.87]	.313 [7.95]
25	.575 [14.60]	.360 [9.14]	.363 [9.22]
31	.650 [16.51]	.435 [11.05]	.438 [11.12]
37	.725 [18.41]	.510 [12.95]	.513 [13.03]

LATCHING WIRED CONNECTOR



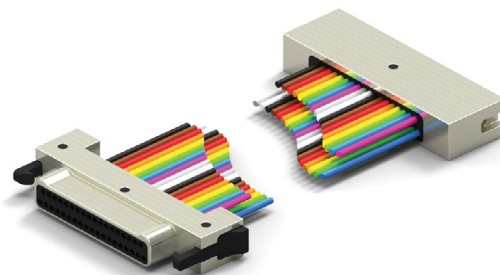

- Metal Shell Connector w/Wire Leads
- Quick Disconnect Latch Mechanism
- Operating Temperature -50° C to 200° C
- 9 to 37 Contacts

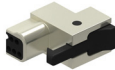

HOW TO ORDER

* Indicates preferred standard ** Consult factory for other plating options

N M L 25 - 2 P Ø2 /NMLX-2XX - 3Ø F 6 - 18.Ø - SØ1

Series	Insulator	Contacts	Insulator Type	Contact Gender	Hardware	Detail of Other End of the Harness	Wire Gauge	Wire Type	Color Code	Length	Finish**	Temp Range	
N= Nano	M= Metal L= LCP	Ø9	2= Dual Row	P= Male/Pin (Plug Side)	Ø4=Latch	Refer to the left columns for filling out the x	3Ø*	*F=Stranded, w/ Teflon insulation, per NEMA HP3-ET	1=White	*18.Ø	Blank= Cadmium	*blank = 125C	
		15					32	Y=Stranded w/ Tefzel insulation, per SAE AS22759/33	*6 = 10 solid colors, repeating	*36.Ø		HT = 200°C	
		21		S=Female/Socket (Receptacle Side)			34	X=Stranded, per DSCC Ø4Ø47-3ØA (White, 3Ø AWG only)				*SØ1= Nickel	
		25											
		31										SØ3 = Black Anodize	
		37										SØ6 = Olive-Drab Cadmium	
											SØ7 = Titanium		
											SØ9 = Stainless		

ELECTRICAL PERFORMANCE DATA	Go to Page 30 See chart 133 E or Click Here for Electrical Performance Data
MECHANICAL PERFORMANCE DATA	Go to Page 30 See chart 123 M or Click Here for Mechanical Performance Data
MATERIALS DATA	Go to Page 30 See chart 149 M&F or Click Here for Materials and Finishes Data

DIMENSIONS

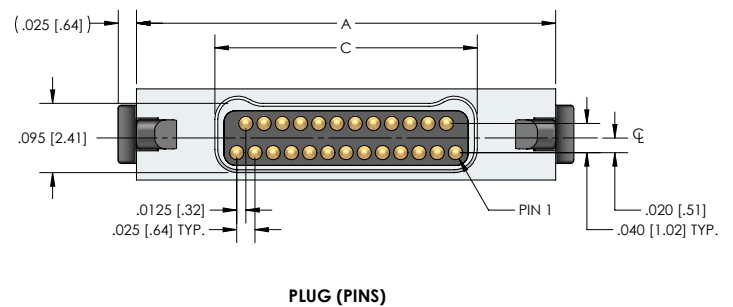
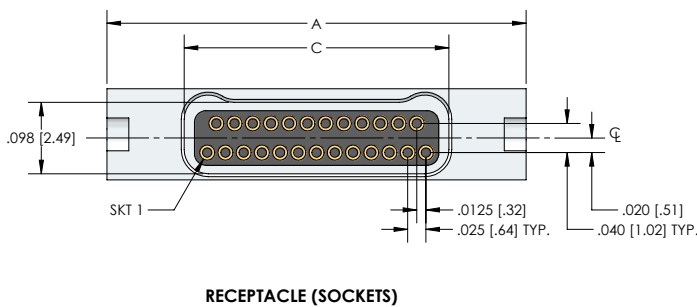
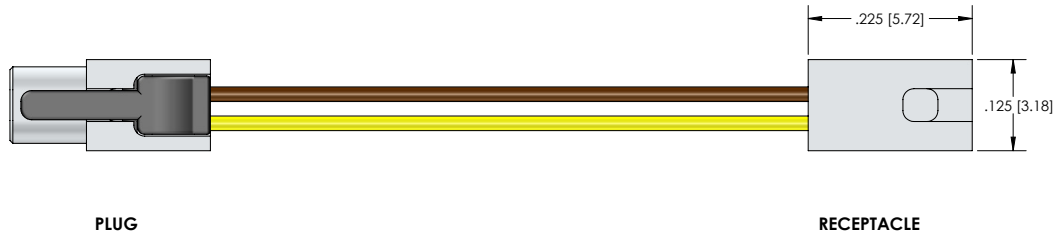
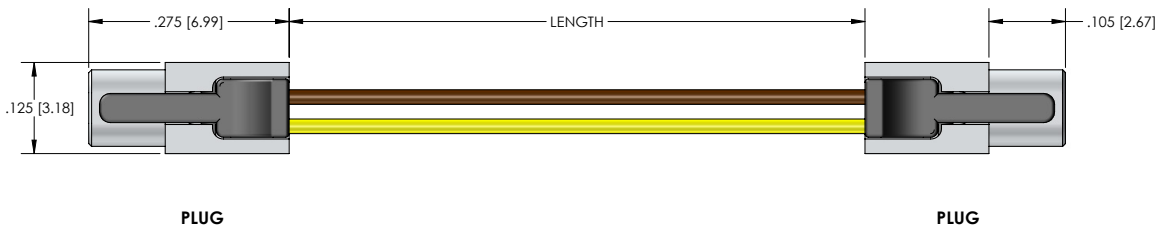

Size	NM SERIES		
	A	Plug	Receptacle
9	.375 [9.52]	.160 [4.06]	.163 [4.14]
15	.450 [11.43]	.235 [5.97]	.238 [6.04]
21	.525 [13.33]	.310 [7.87]	.313 [7.95]
25	.575 [14.60]	.360 [9.14]	.363 [9.22]
31	.650 [16.51]	.435 [11.05]	.438 [11.12]
37	.725 [18.41]	.510 [12.95]	.513 [13.03]

LATCHING CIRCUIT RIGHT ANGLE CONNECTOR







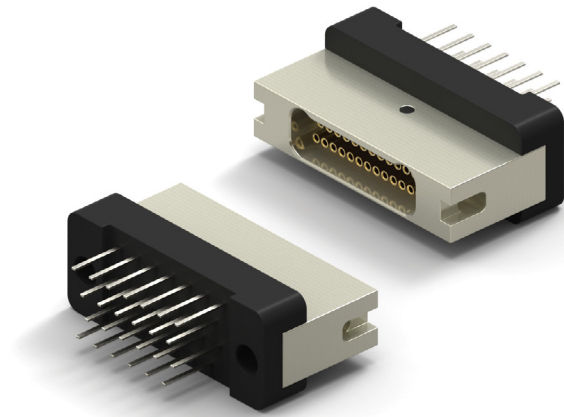

- Metal Shell Connector
- Plated Thru Hole .050 x .050 (Style 6)
- 1 Piece Contact
- Flat Tail Termination
- Operating Temperature -50° C to 200° C
- 9 to 65 Contacts

HOW TO ORDER

* Indicates preferred standard ** Consult factory for other plating options



NANO D – PID 151

CN	M	6	L	25	-2	S	Ø4	1	-SØ1	Temp Range
Series	Style	Insulator	Contacts	Insulator Type	Contact Gender	Hardware	Color Code	Finish**		
CN=Nano	M= Metal Shell	Style=6	L=LCP	Ø9	2= Dual Row	S=Female/Socket (Receptacle Side)	Ø4=Latch	1= Tin plated (6Ø/4Ø)	Blank= Cadmium	*blank = 125C
				15				2= Gold plated (RoHS)		HT = 200C
				21					*SØ1= Nickel	
				25						
				31					SØ3 = Black Anodize	
				37						
				51					SØ6 = Olive-Drab Cadmium	
				65						
									SØ7 =Titanium	
										
									SØ9=Stainless	
										

ELECTRICAL PERFORMANCE DATA	Go to Page 31 See chart 133 E or Click Here for Electrical Performance Data
MECHANICAL PERFORMANCE DATA	Go to Page 31 See chart 123 M or Click Here for Mechanical Performance Data
MATERIALS DATA	Go to Page 31 See chart 131 M&F or Click Here for Materials and Finishes Data

DIMENSIONS

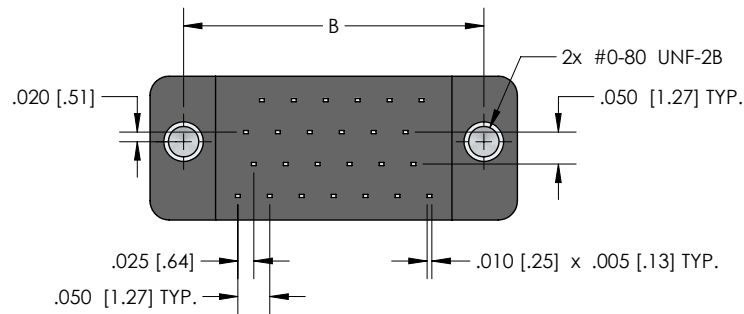
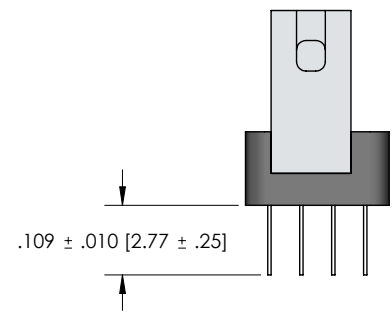
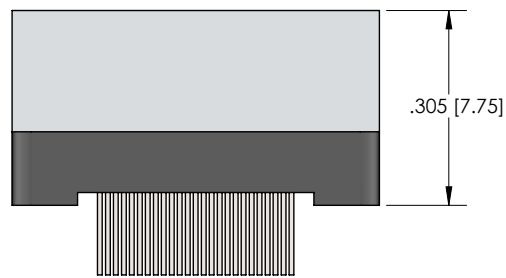
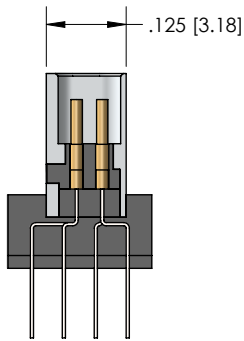
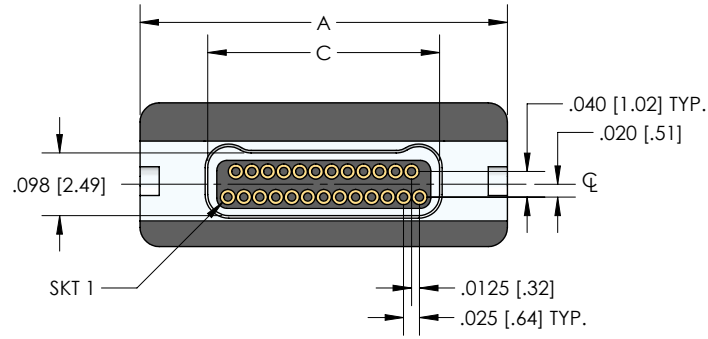

M SERIES				
Size	A	Plug C	Receptacle	D
9	.375 [9.52]	.160 [4.06]	.163 [4.14]	.175 [4.44]
15	.450 [11.43]	.235 [5.97]	.238 [6.04]	.250 [6.35]
21	.525 [13.33]	.310 [7.87]	.313 [7.95]	.325 [8.25]
25	.575 [14.60]	.360 [9.14]	.363 [9.22]	.375 [9.52]
31	.650 [16.51]	.435 [11.05]	.438 [11.12]	.450 [11.43]
37	.725 [18.41]	.510 [12.95]	.513 [13.03]	.525 [13.33]
51	.900 [22.86]	.685 [17.40]	.688 [17.47]	.700 [17.78]
65	1.075 [27.30]	.860 [21.84]	.863 [21.92]	.875 [22.22]

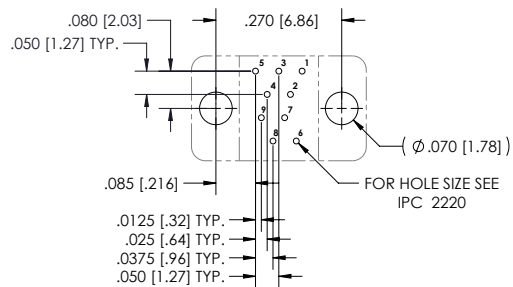
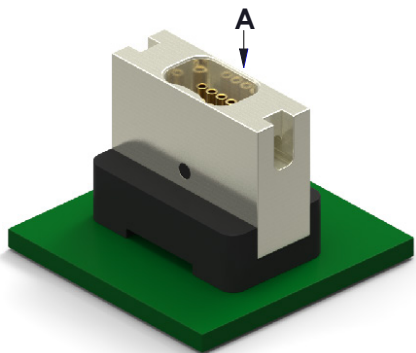

SIZE 9 - VIEW A

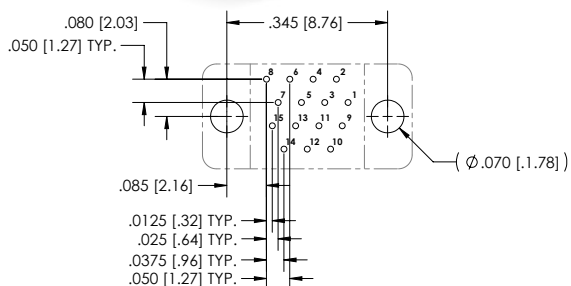

SIZE 15 - VIEW A

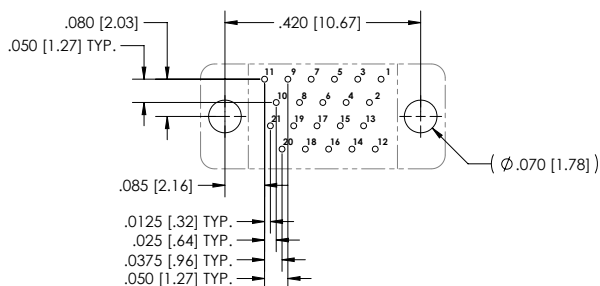

SIZE 21 - VIEW A

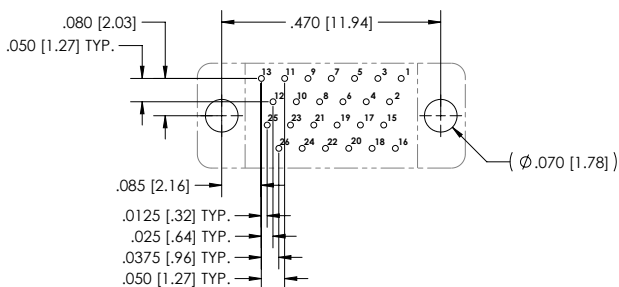

SIZE 25 - VIEW A

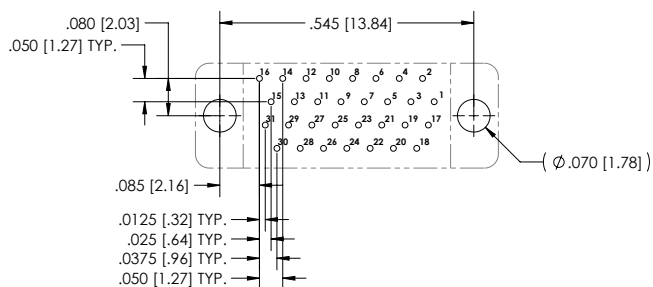

SIZE 31 - VIEW A

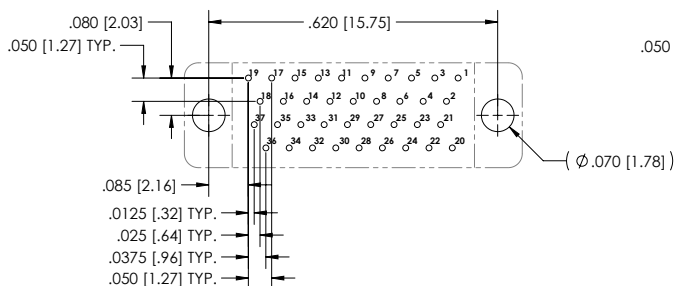

SIZE 37 - VIEW A

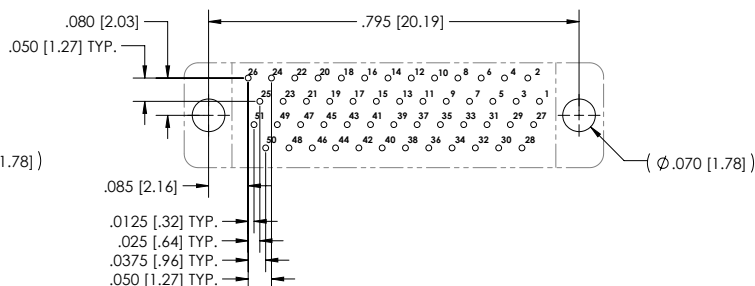

SIZE 51 - VIEW A

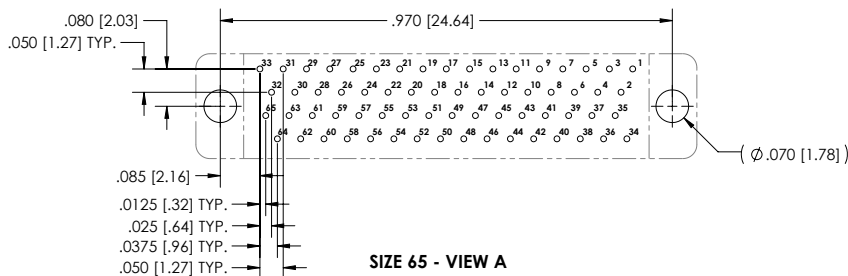

SIZE 65 - VIEW A

THIS PAGE LEFT
INTENTIONALLY BLANK

LATCHING CIRCUIT VERTICAL CONNECTOR



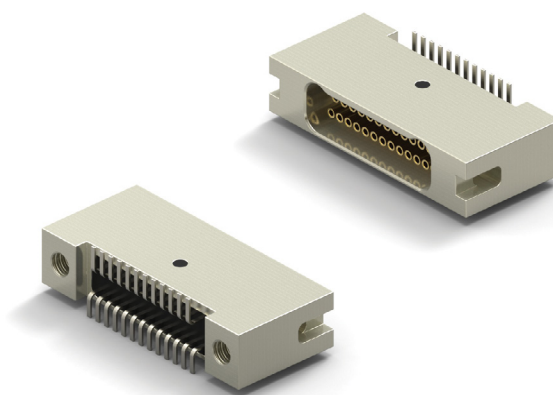





- Metal Shell Connector
- Surface Mount .025 x .075 (Style 26)
- 1 Piece Contact
- Flat Tail Termination
- Operating Temperature -50° C to 200° C
- 9 to 65 Contacts



HOW TO ORDER

* Indicates preferred standard ** Consult factory for other plating options

CN M 26 L 25 - 2 S 04 1 - S01

CN	Series	Style	Insulator	Contacts	Insulator Type	Contact Gender	Hardware	Color Code	Finish**	Temp Range
CN=Nano	M= Metal Shell	Style=26	L=LCP	09	2= Dual Row	S=Female/Socket (Receptacle Side)	Ø4=Latch	1= Tin plated (60/40)	Blank= Cadmium	*blank = 125C
				15				2= Gold plated (RoHS)		HT = 200C
				21					*S01= Nickel	
				25						
				31					S03 = Black Anodize	
				37						
				51					S06 = Olive-Drab Cadmium	
				65						
									S07 = Titanium	
										
									S09 = Stainless	
										

ELECTRICAL PERFORMANCE DATA	Go to Page 31 See chart 133 E or Click Here for Electrical Performance Data
MECHANICAL PERFORMANCE DATA	Go to Page 31 See chart 123 M or Click Here for Mechanical Performance Data
MATERIALS DATA	Go to Page 31 See chart 131 M&F or Click Here for Materials and Finishes Data

DIMENSIONS

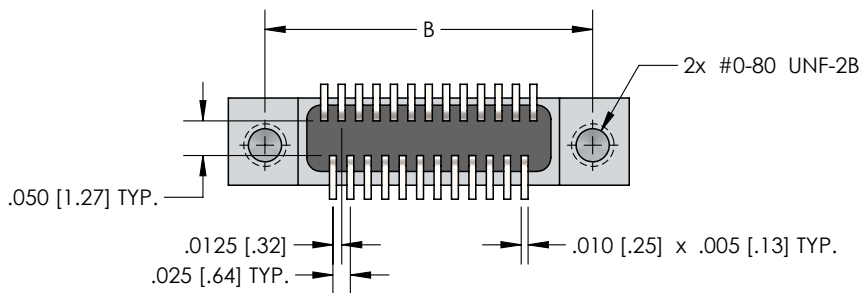
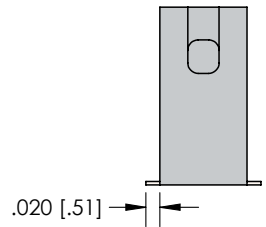
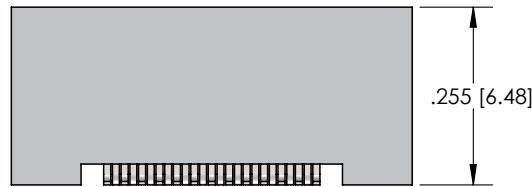
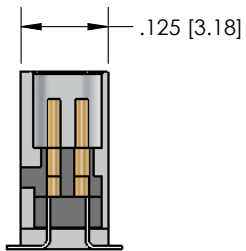
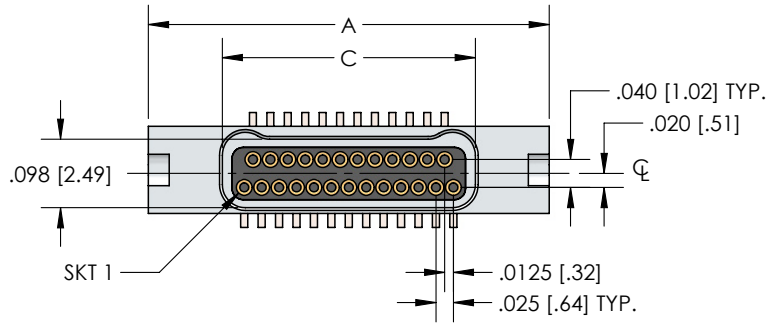

CNM SERIES						
Size	A	Plug C	Receptacle	D	E	F
9	.375 [9.52]	.160 [4.06]	.163 [4.14]	.175 [4.44]	.100 [2.54]	.075 [1.90]
15	.450 [11.43]	.235 [5.97]	.238 [6.04]	.250 [6.35]	.175 [4.44]	.150 [3.81]
21	.525 [13.33]	.310 [7.87]	.313 [7.95]	.325 [8.25]	.250 [6.35]	.225 [5.71]
25	.575 [14.60]	.360 [9.14]	.363 [9.22]	.375 [9.52]	.300 [7.62]	.275 [6.98]
31	.650 [16.51]	.435 [11.05]	.438 [11.12]	.450 [11.43]	.375 [9.52]	.350 [8.89]
37	.725 [18.41]	.510 [12.95]	.513 [13.03]	.525 [13.33]	.450 [11.43]	.425 [10.79]
51	.900 [22.86]	.685 [17.40]	.688 [17.47]	.700 [17.78]	.625 [15.87]	.600 [15.24]
65	1.075 [27.30]	.860 [21.84]	.863 [21.92]	.875 [22.22]	.800 [20.32]	.775 [19.68]

LATCHING CIRCUIT VERTICAL CONNECTOR

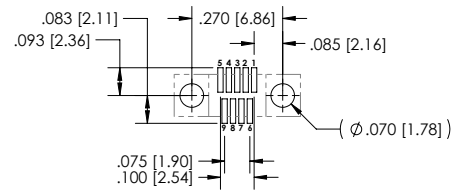
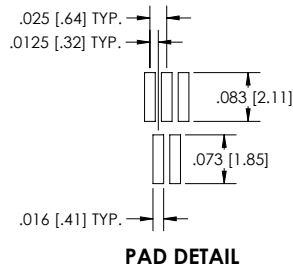
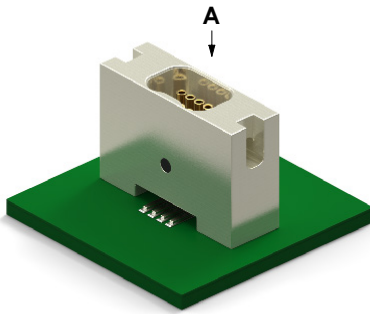

SIZE 9 - VIEW A

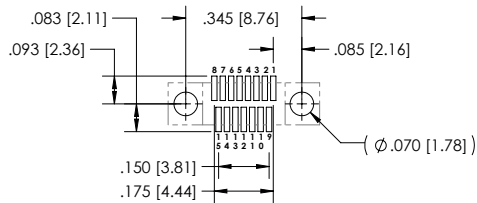

SIZE 15 - VIEW A

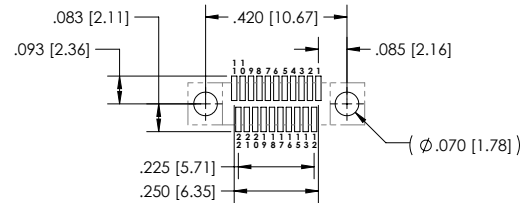

SIZE 21 - VIEW A

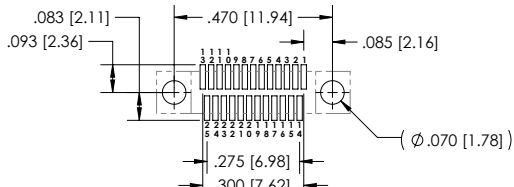

SIZE 25 - VIEW A

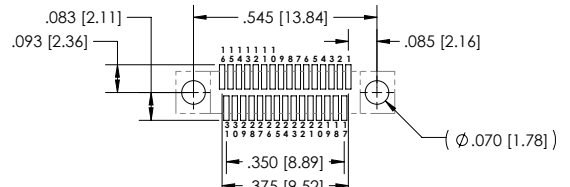

SIZE 31 - VIEW A

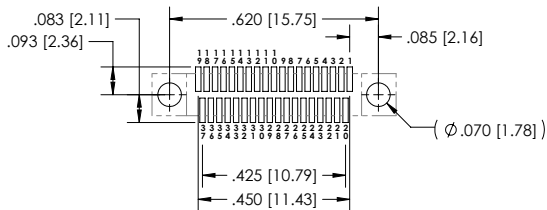

SIZE 37 - VIEW A

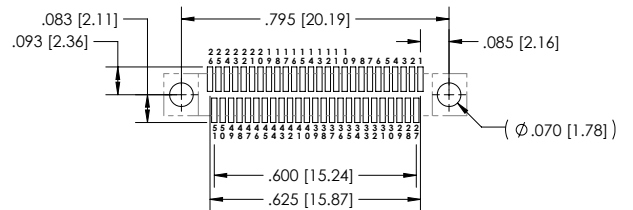

SIZE 51 - VIEW A

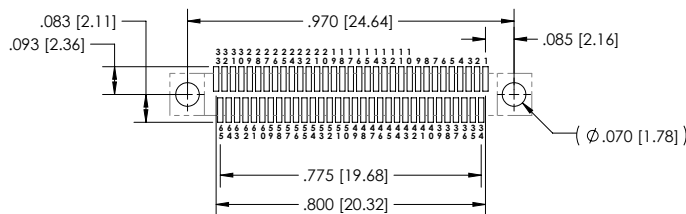

SIZE 65 - VIEW A

THIS PAGE LEFT
INTENTIONALLY BLANK





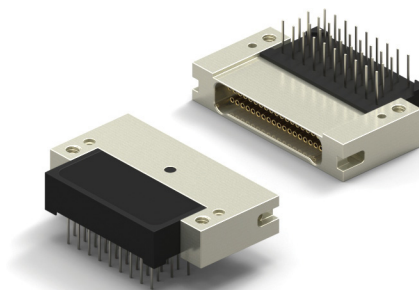





LATCHING CIRCUIT RIGHT ANGLE CONNECTOR

- Metal Shell Connector
- Quick Disconnect Latch Mechanism
- Plated Thru Hole .050 x .050 (Style 8)
- 1 Piece Contact
- Flat Tail Termination
- Operating Temperature -50° C to 200° C
- 9 to 37 Contacts



HOW TO ORDER

* Indicates preferred standard ** Consult factory for other plating options

CN	M	8	L	25	-	2	S	Ø4	1	-	SØ1	
	Series	Style	Insulator	Contacts	Insulator Type	Contact Gender	Hardware	Color Code	Finish**	Temp Range	Mounting Option	
CN=Nano	M= Metal Shell	Style=8	L=LCP	Ø9	2= Dual Row	S=Female/Socket (Receptacle Side)	Ø4=Latch	1= Tin plated (6Ø/4Ø)	Blank= Cadmium	*blank = 125C	*Blank=Threaded Mounting Holes	
				15				2= Gold plated (RoHS)		HT = 200°C		
				21					*SØ1= Nickel		1=Solder Alignment Posts with Threaded Mounting Holes	
				25								
				31					SØ3 = Black Anodize			
				37								
									SØ6 = Olive-Drab Cadmium			
												
									SØ7 = Titanium			
												
									SØ9=Stainless			
												

ELECTRICAL PERFORMANCE DATA	Go to Page 31 See chart 133 E or Click Here for Electrical Performance Data
MECHANICAL PERFORMANCE DATA	Go to Page 31 See chart 123 M or Click Here for Mechanical Performance Data
MATERIALS DATA	Go to Page 31 See chart 131 M&F or Click Here for Materials and Finishes Data

DIMENSIONS

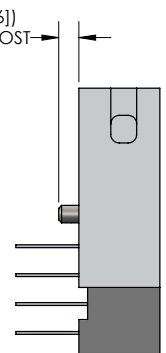
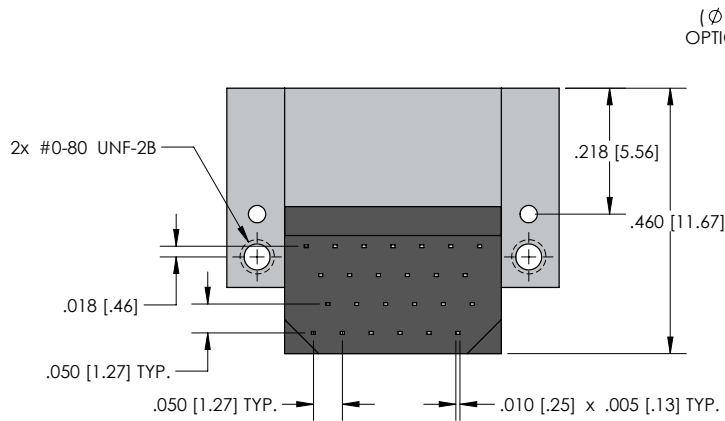
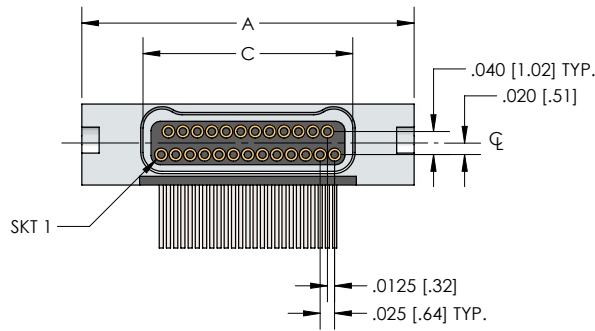
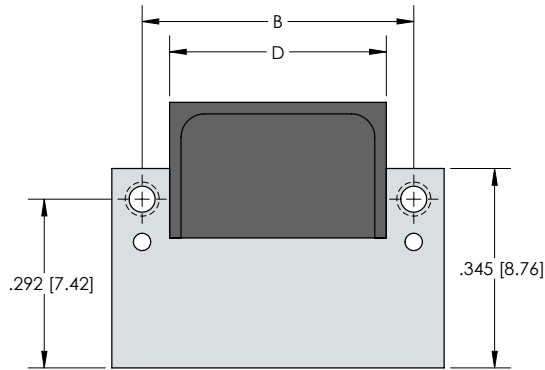
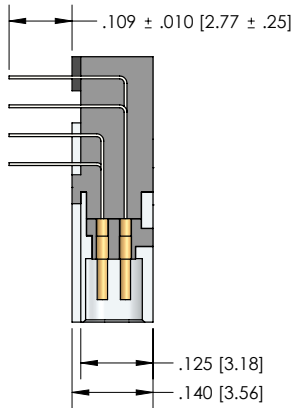

Size	CNM SERIES				
	A	B	Plug C	Receptacle	D
9	.375 [9.52]	.270 [6.86]	.160 [4.06]	.163 [4.14]	.175 [4.44]
15	.450 [11.43]	.345 [8.76]	.235 [5.97]	.238 [6.04]	.250 [6.35]
21	.525 [13.33]	.420 [10.67]	.310 [7.87]	.313 [7.95]	.325 [8.25]
25	.575 [14.60]	.470 [11.94]	.360 [9.14]	.363 [9.22]	.375 [9.52]
31	.650 [16.51]	.545 [13.84]	.435 [11.05]	.438 [11.12]	.450 [11.43]
37	.725 [18.41]	.620 [15.75]	.510 [12.95]	.513 [13.03]	.525 [13.33]

LATCHING CIRCUIT RIGHT ANGLE CONNECTOR PCB LAYOUT

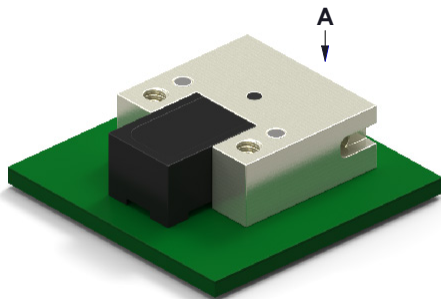

NANO D - PID 1.54

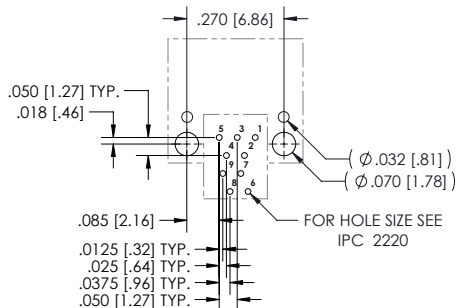

SIZE 9 - VIEW A

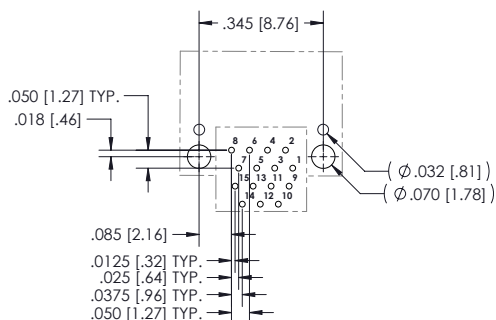

SIZE 15 - VIEW A

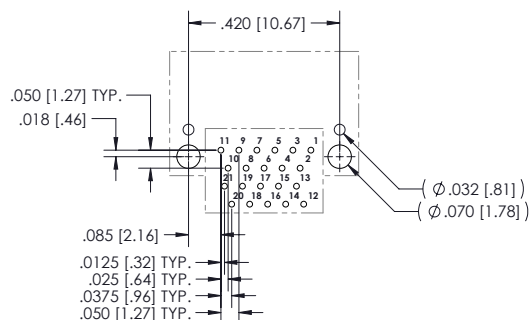

SIZE 21 - VIEW A

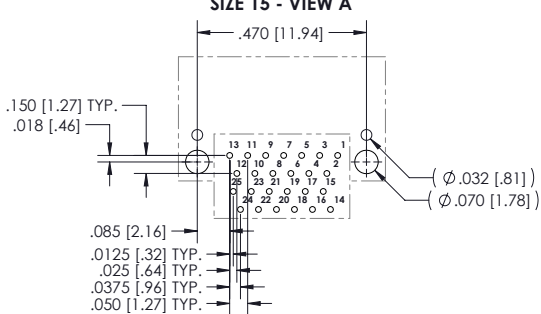

SIZE 25 - VIEW A

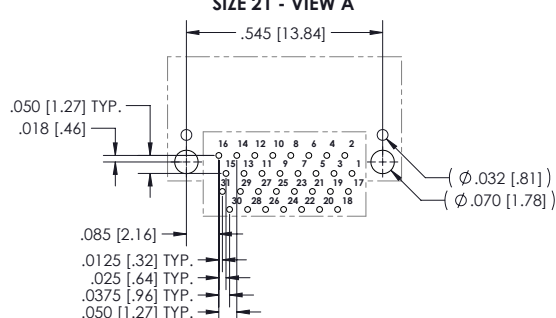

SIZE 31 - VIEW A

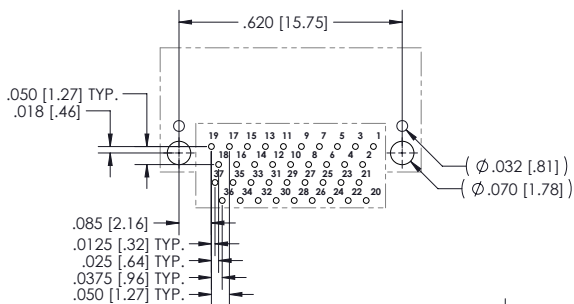

SIZE 37 - VIEW A

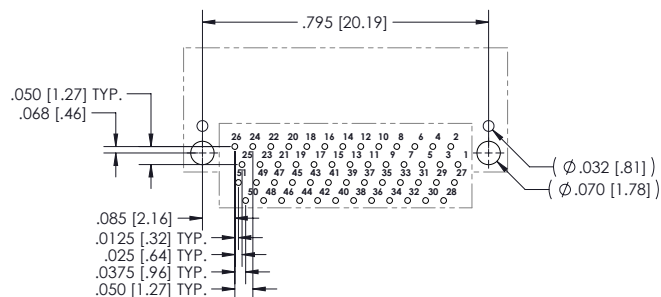

SIZE 51 - VIEW A

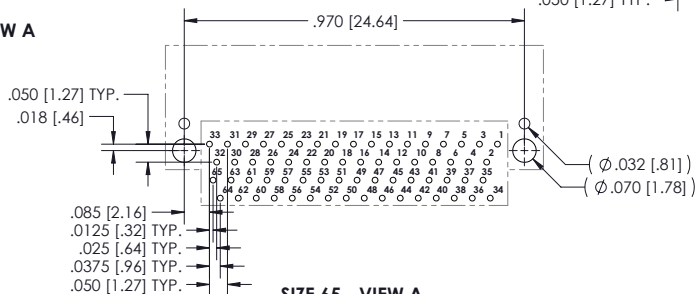

SIZE 65 - VIEW A

THIS PAGE LEFT
INTENTIONALLY BLANK





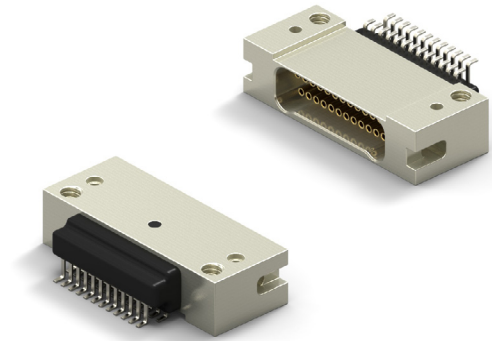





LATCHING CIRCUIT RIGHT ANGLE CONNECTOR

- Metal Shell Connector
- Quick Disconnect Latch Mechanism
- Surface Mount .025 x .040 (Style 28)
- 1 Piece Contact
- Flat Tail Termination
- Operating Temperature -50° C to 200° C
- 9 to 37 Contacts



HOW TO ORDER

* Indicates preferred standard ** Consult factory for other plating options

CN	M	28	L	25	2	S	Ø4	1	- SØ1	Temp Range	Mounting Option
Series	Style	Insulator	Contacts	Insulator Type	Contact Gender	Hardware	Color Code	Finish**			
CN=Nano	M= Metal Shell	Style=28	L=LCP	Ø9	2= Dual Row	S=Female/Socket (Receptacle Side)	Ø4=Latch	1= Tin plated (60/40)	Blank= Cadmium	*blank = 125C	*Blank=Threaded Mounting Holes
				15				2=Gold plated (RoHS)		HT = 200°C	
				21					*SØ1 = Nickel		1=Solder Alignment Posts with Threaded Mounting Holes
				25							
				31					SØ3 = Black Anodize		
				37							
									SØ6 = Olive-Drab Cadmium		
											
									SØ7 = Titanium		
											
									SØ9=Stainless		
											

ELECTRICAL PERFORMANCE DATA	Go to Page 31 See chart 133 E or Click Here for Electrical Performance Data
MECHANICAL PERFORMANCE DATA	Go to Page 31 See chart 123 M or Click Here for Mechanical Performance Data
MATERIALS DATA	Go to Page 31 See chart 131 M&F or Click Here for Materials and Finishes Data

DIMENSIONS

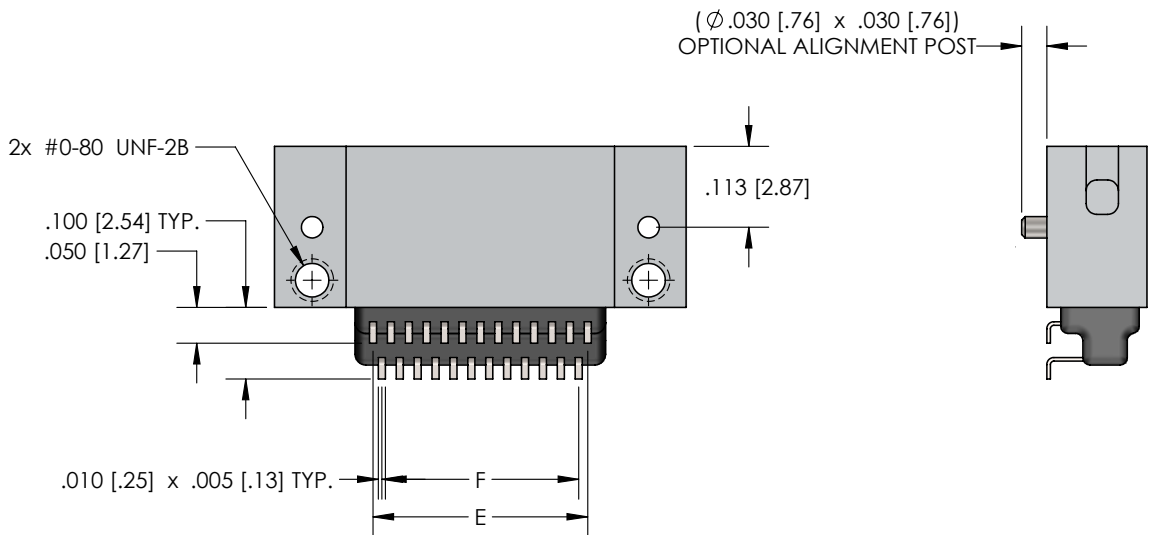
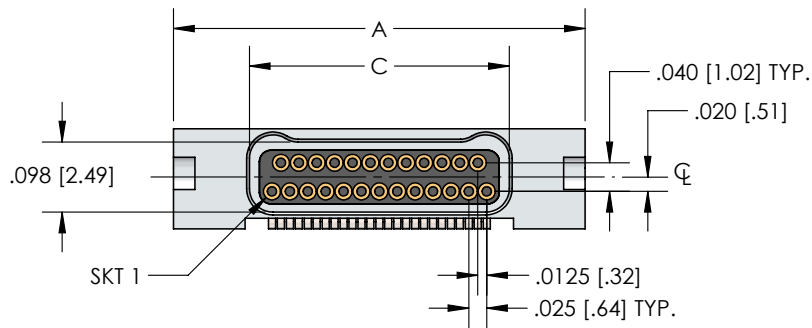
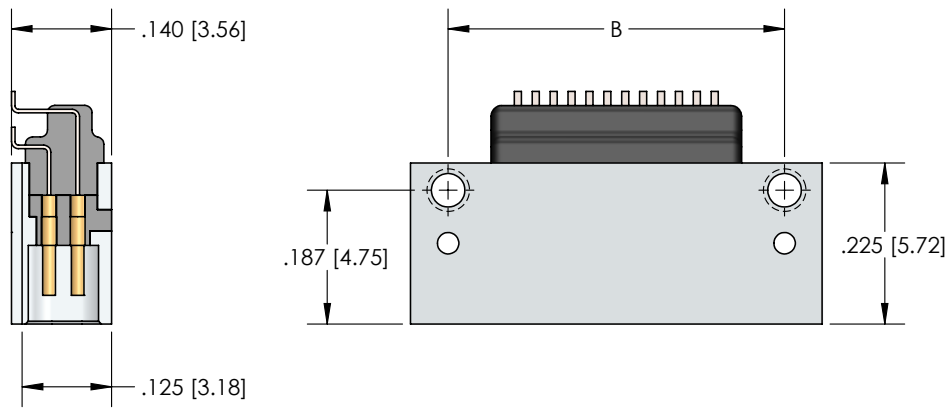

CNM SERIES							
Size	A	B	Plug C	Receptacle	D	E	F
9	.375 [9.52]	.270 [6.86]	.160 [4.06]	.163 [4.14]	.175 [4.44]	.100 [2.54]	.075 [1.90]
15	.450 [11.43]	.345 [8.76]	.235 [5.97]	.238 [6.04]	.250 [6.35]	.175 [4.44]	.150 [3.81]
21	.525 [13.33]	.420 [10.67]	.310 [7.87]	.313 [7.95]	.325 [8.25]	.250 [6.35]	.225 [5.71]
25	.575 [14.60]	.470 [11.94]	.360 [9.14]	.363 [9.22]	.375 [9.52]	.300 [7.62]	.275 [6.98]
31	.650 [16.51]	.545 [13.84]	.435 [11.05]	.438 [11.12]	.450 [11.43]	.375 [9.52]	.350 [8.89]
37	.725 [18.41]	.620 [15.75]	.510 [12.95]	.513 [13.03]	.525 [13.33]	.450 [11.43]	.425 [10.79]

LATCHING CIRCUIT RIGHT ANGLE CONNECTOR PCB LAYOUT

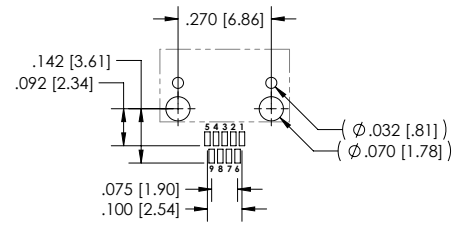
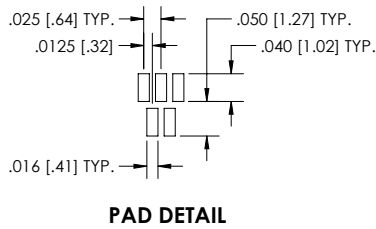
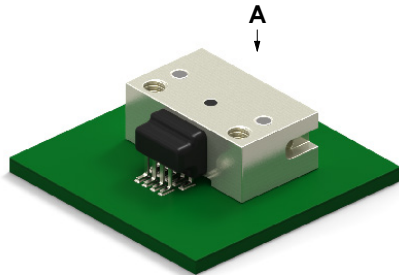

SIZE 9 - VIEW A

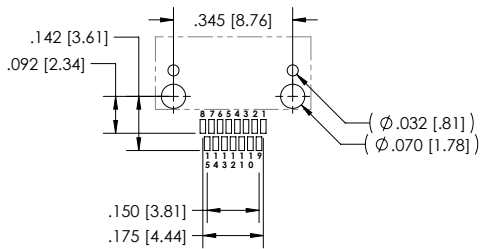

SIZE 15 - VIEW A

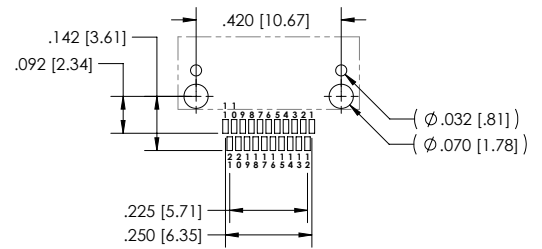

SIZE 21 - VIEW A

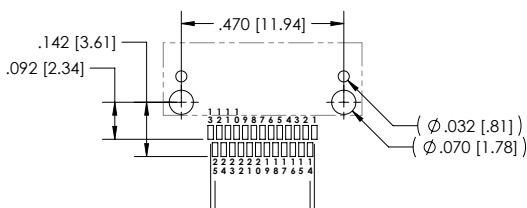

SIZE 25 - VIEW A

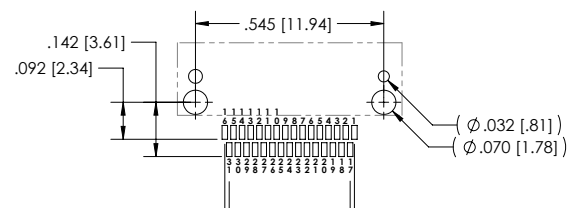

SIZE 31 - VIEW A

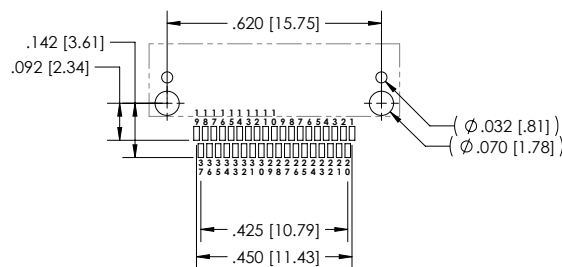

SIZE 37 - VIEW A

THIS PAGE LEFT
INTENTIONALLY BLANK





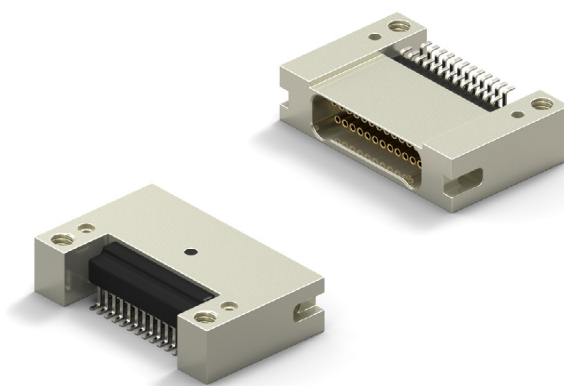





LATCHING CIRCUIT RIGHT ANGLE CONNECTOR

- Metal Shell Connector
- Quick Disconnect Latch Mechanism
- Surface Mount .025 x .040 (Style 38)
- 1 Piece Contact
- Flat Tail Termination
- Operating Temperature -50° C to 200° C
- 9 to 37 Contacts



HOW TO ORDER

* Indicates preferred standard ** Consult factory for other plating options

CN	M	38	L	25	- 2	S	Ø4	1	- SØ1	Temp Range	Mounting Option
Series	Style	Insulator	Contacts	Insulator Type	Contact Gender	Hardware	Color Code	Finish**			
CN=Nano	M= Metal Shell	Style=38	L=LCP	Ø9	2= Dual Row	S=Female/Socket (Receptacle Side)	Ø4=Latch	1= Tin plated (60/40)	Blank= Cadmium	*blank = 125C	*Blank=Threaded Mounting Holes
				15				2= Gold plated (RoHS)		HT = 200°C	
				21					*SØ1= Nickel		1=Solder Alignment Posts with Threaded Mounting Holes
				25							
				31					SØ3 = Black Anodize		
				37							
									SØ6 = Olive-Drab Cadmium		
											
									SØ7 = Titanium		
											
									SØ9=Stainless		
											

ELECTRICAL PERFORMANCE DATA	Go to Page 31 See chart 133 E or Click Here for Electrical Performance Data
MECHANICAL PERFORMANCE DATA	Go to Page 31 See chart 123 M or Click Here for Mechanical Performance Data
MATERIALS DATA	Go to Page 31 See chart 131 M&F or Click Here for Materials and Finishes Data

DIMENSIONS

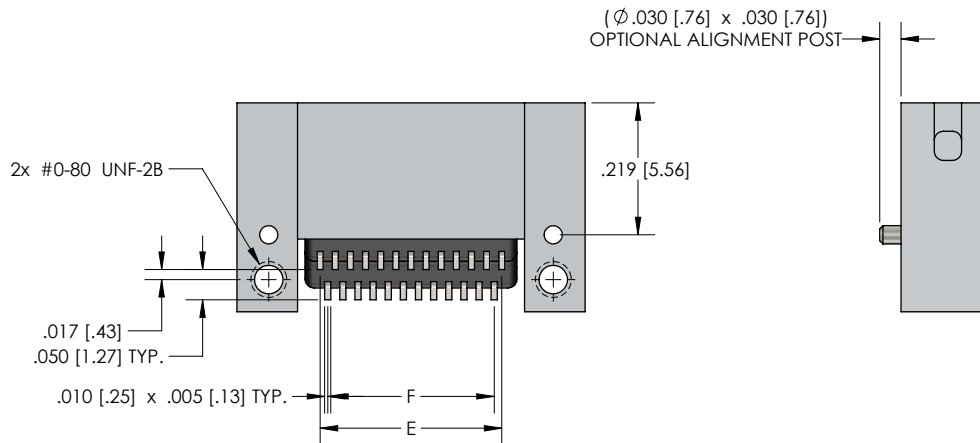
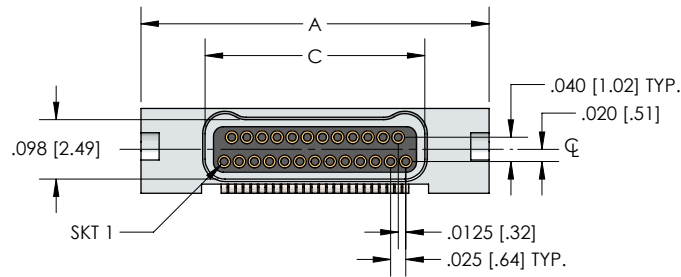
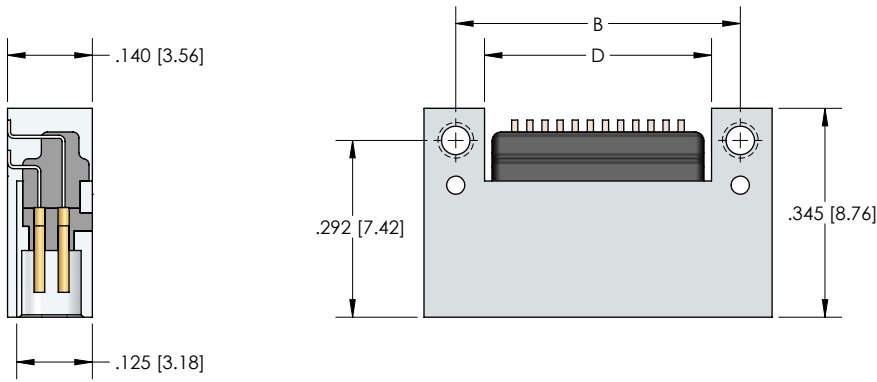

CNM SERIES								
Size	A	B	Plug C	Receptacle	D	E	F	
9	.375 [9.52]	.270 [6.86]	.160 [4.06]	.163 [4.14]	.175 [4.44]	.100 [2.54]	.075 [1.90]	
15	.450 [11.43]	.345 [8.76]	.235 [5.97]	.238 [6.04]	.250 [6.35]	.175 [4.44]	.150 [3.81]	
21	.525 [13.33]	.420 [10.67]	.310 [7.87]	.313 [7.95]	.325 [8.25]	.250 [6.35]	.225 [5.71]	
25	.575 [14.60]	.470 [11.94]	.360 [9.14]	.363 [9.22]	.375 [9.52]	.300 [7.62]	.275 [6.98]	
31	.650 [16.51]	.545 [13.84]	.435 [11.05]	.438 [11.12]	.450 [11.43]	.375 [9.52]	.350 [8.89]	
37	.725 [18.41]	.620 [15.75]	.510 [12.95]	.513 [13.03]	.525 [13.33]	.450 [11.43]	.425 [10.79]	

LATCHING CIRCUIT RIGHT ANGLE CONNECTOR PCB LAYOUT

NANO D – PID 156

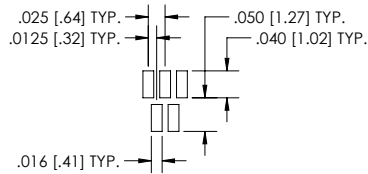
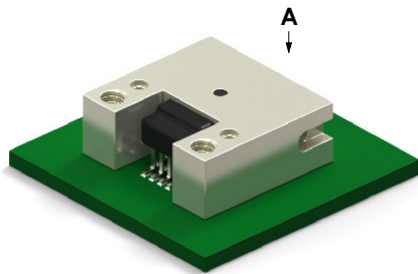

PAD DETAIL

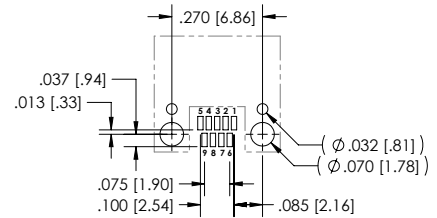

SIZE 9 - VIEW A

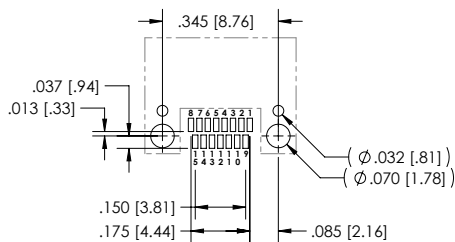

SIZE 15 - VIEW A

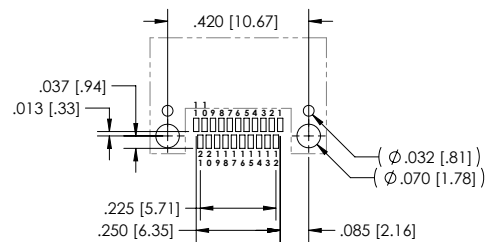

SIZE 21 - VIEW A

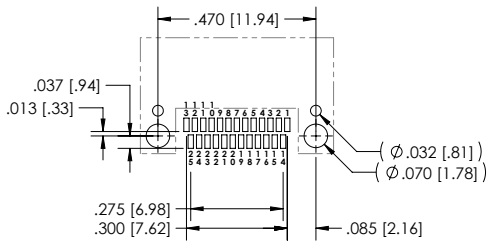

SIZE 25 - VIEW A

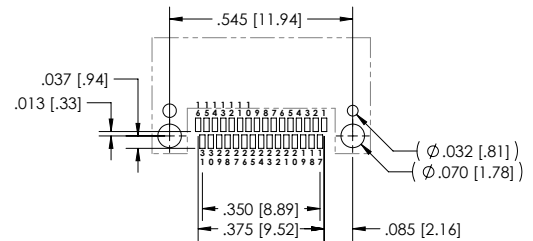

SIZE 31 - VIEW A

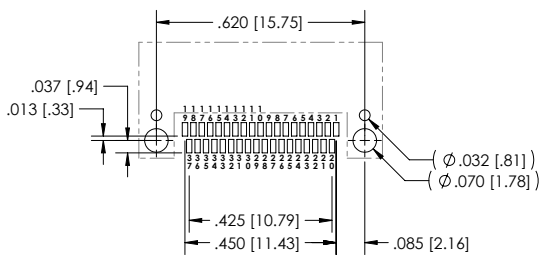

SIZE 37 - VIEW A

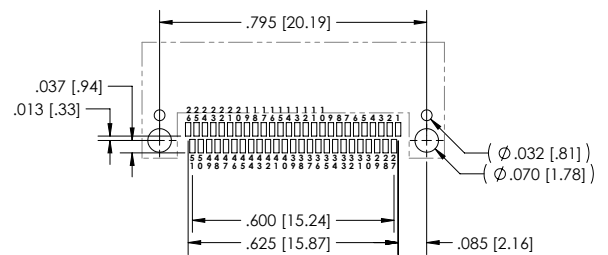

SIZE 51 - VIEW A

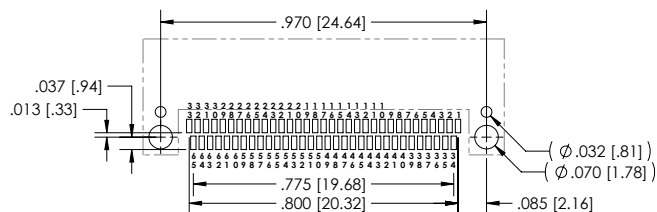

SIZE 65 - VIEW A

THIS PAGE LEFT
INTENTIONALLY BLANK





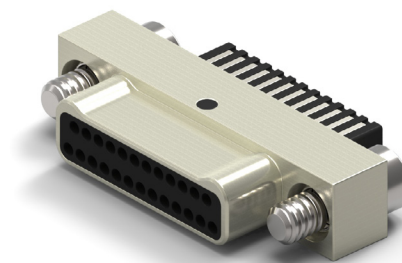









FIELD SOLDERABLE CONNECTOR

- Metal Shell Connector w/Flat Leads
- Operating Temperature -50° C to 200°C
- 9 to 65 Contacts



HOW TO ORDER

* Indicates preferred standard ** Consult factory for other plating options

N	M	L	25	-	2	N	Ø2	3	-	SØ1	Temp Range
Series	Insulator	Contacts	Insulator Type	Contact Gender	Hardware	Color Code	Finish**				
N=Nano	M=Metal	L=LCP	Ø9	2= Dual Row	N=Male/Pin (Plug Side)	Ø1=Phillips Head Jackscrew	3= Tin plated (6Ø/4Ø)	Blank= Cadmium	*blank = 125C		
		15					4= Gold plated (RoHS)		HT = 200°C		
		21			T=Female/Socket (Receptacle Side)	Ø2=Allen Head Jackscrew		*SØ1= Nickel			
		25									
		31				Ø5=Slotted Head Jackscrew		SØ3 = Black Anodize			
		37									
		51				Ø6= Floating Phillips Head Jackscrew (Female Only)		SØ6 = Olive-Drab Cadmium			
		65									
						Ø7=Threaded Hole		SØ7 =Titanium			
											
						Ø8= Floating Allen Head Jackscrew (Female Only)		SØ9 =Stainless			
											
						Ø9= Floating Slotted Head Jackscrew (Female Only)					
											

ELECTRICAL PERFORMANCE DATA	Go to Page 32 See chart 133 E or Click Here for Electrical Performance Data
MECHANICAL PERFORMANCE DATA	Go to Page 32 See chart 123 M or Click Here for Mechanical Performance Data
MATERIALS DATA	Go to Page 32 See chart 126 M&F or Click Here for Materials and Finishes Data

NANO D – PID 158

DIMENSIONS

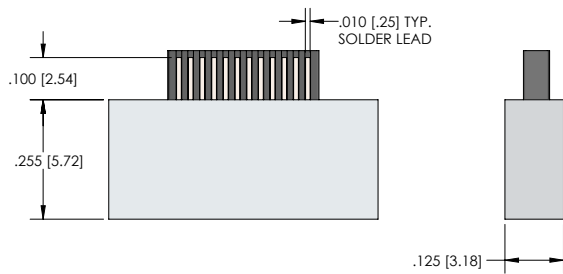

RECEPTACLE (SOCKETS)

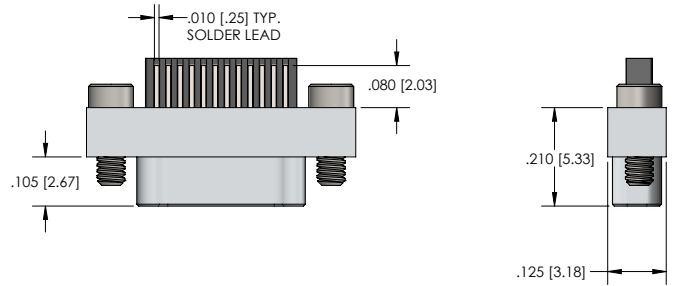

PLUG (PINS)

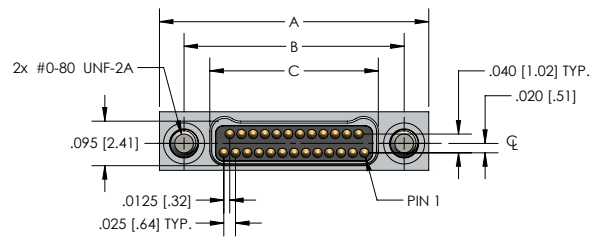
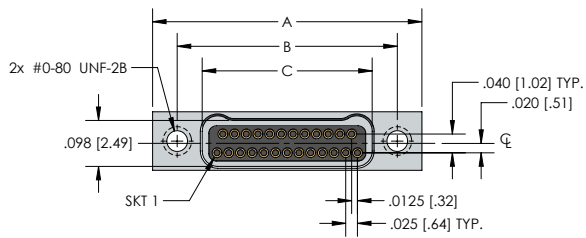

Size	NM SERIES			
	A	B	Plug C	Receptacle
9	.375 [9.52]	.270 [6.86]	.160 [4.06]	.163 [4.14]
15	.450 [11.43]	.345 [8.76]	.235 [5.97]	.238 [6.04]
21	.525 [13.33]	.420 [10.67]	.310 [7.87]	.313 [7.95]
25	.575 [14.60]	.470 [11.94]	.360 [9.14]	.363 [9.22]
31	.650 [16.51]	.545 [13.84]	.435 [11.05]	.438 [11.12]
37	.725 [18.41]	.620 [15.75]	.510 [12.95]	.513 [13.03]
51	.900 [22.86]	.795 [20.19]	.685 [17.40]	.688 [17.47]
65	1.075 [27.30]	.970 [24.64]	.860 [21.84]	.863 [21.92]





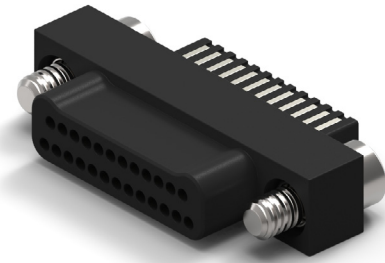



FIELD SOLDERABLE CONNECTOR

- Plastic Shell Connector w/Flat Leads
- Operating Temperature -50° C to 200°C
- 9 to 65 Contacts



HOW TO ORDER

* Indicates preferred standard

N	P	L	25	- 2	N	Ø2	- 3	
Series	Insulator	Contacts	Insulator Type	Contact Gender	Hardware	Lead Finish	Temp Range	
N=Nano	P=Plastic	L=LCP	Ø9	2= Dual Row	N=Male/Pin (Plug Side)	Ø1=Phillips Head Jackscrew	*3= Tin plated (6Ø/4Ø)	*blank = 125C
		15				4=Gold plated (RoHS)	HT = 200°C	
		21		T=Female/Socket (Receptacle Side)	Ø2=Allen Head Jackscrew			
		25						
		31			Ø5=Slotted Head Jackscrew			
		37						
		51			Ø6=Floating Phillips Head Jackscrew (Female Only)			
		65						
					Ø7=Threaded Hole			
								
					Ø8=Floating Allen Head Jackscrew (Female Only)			
								
					Ø9=Floating Slotted Head Jackscrew (Female Only)			
								

ELECTRICAL PERFORMANCE DATA	Go to Page 32 See chart 133 E or Click Here for Electrical Performance Data
MECHANICAL PERFORMANCE DATA	Go to Page 32 See chart 123 M or Click Here for Mechanical Performance Data
MATERIALS DATA	Go to Page 32 See chart 126 M&F or Click Here for Materials and Finishes Data

NANO D – PID 159

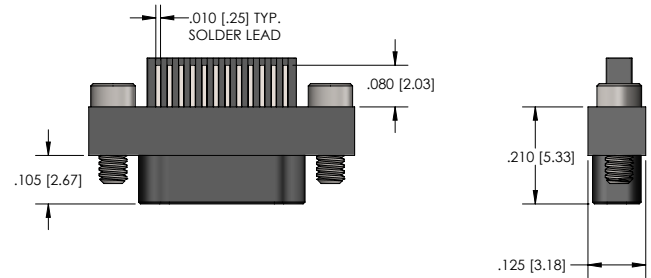
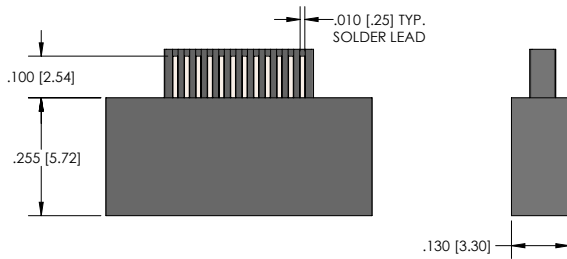

RECEPTACLE (SOCKETS)

PLUG (PINS)

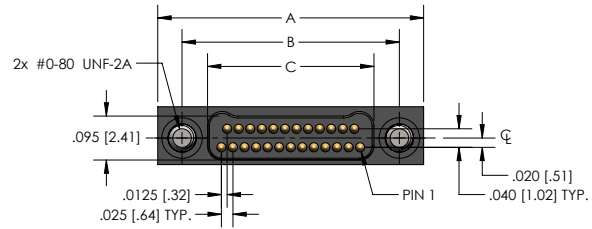
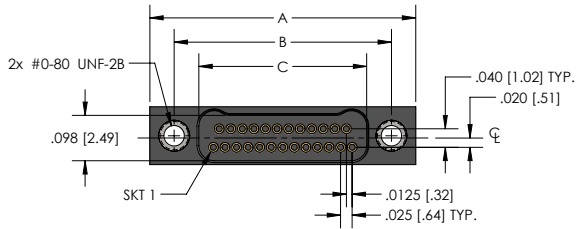

Size	NP SERIES			
	A	B	Plug C	Receptacle
9	.375 [9.52]	.270 [6.86]	.160 [4.06]	.163 [4.14]
15	.450 [11.43]	.345 [8.76]	.235 [5.97]	.238 [6.04]
21	.525 [13.33]	.420 [10.67]	.310 [7.87]	.313 [7.95]
25	.575 [14.60]	.470 [11.94]	.360 [9.14]	.363 [9.22]
31	.650 [16.51]	.545 [13.84]	.435 [11.05]	.438 [11.12]
37	.725 [18.41]	.620 [15.75]	.510 [12.95]	.513 [13.03]
51	.900 [22.86]	.795 [20.19]	.685 [17.40]	.688 [17.47]
65	1.075 [27.30]	.970 [24.64]	.860 [21.84]	.863 [21.92]

FIELD SOLDERABLE CONNECTOR

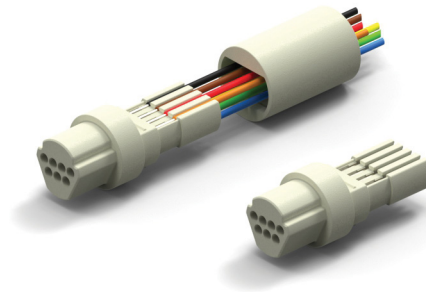

- Plastic Shell Connector w/Flat Leads
- Operating Temperature -50° C to 200°C
- 7 Contacts



NANO D – PID 160

HOW TO ORDER

* Indicates preferred standard

RN	P	O	P	- Ø7	N	- 3	
	Series	Mounting Style	Material/Plating	Connector Size	Contact Gender	Color Code	Temp Range
RN= Round Nano	P=Plastic	O=Inline	P=Plastic	Ø7	N=Male/Pin (Plug Side)	3= Tin plated (6Ø/4Ø)	*blank = 125C
						4= Gold plated (RoHS)	HT = 200°C
					T=Female/Socket (Receptacle Side)		
							

ELECTRICAL PERFORMANCE DATA	Go to Page 32 See chart 133 E or Click Here for Electrical Performance Data
MECHANICAL PERFORMANCE DATA	Go to Page 32 See chart 123 M or Click Here for Mechanical Performance Data
MATERIALS DATA	Go to Page 32 See chart 126 M&F or Click Here for Materials and Finishes Data

DIMENSIONS

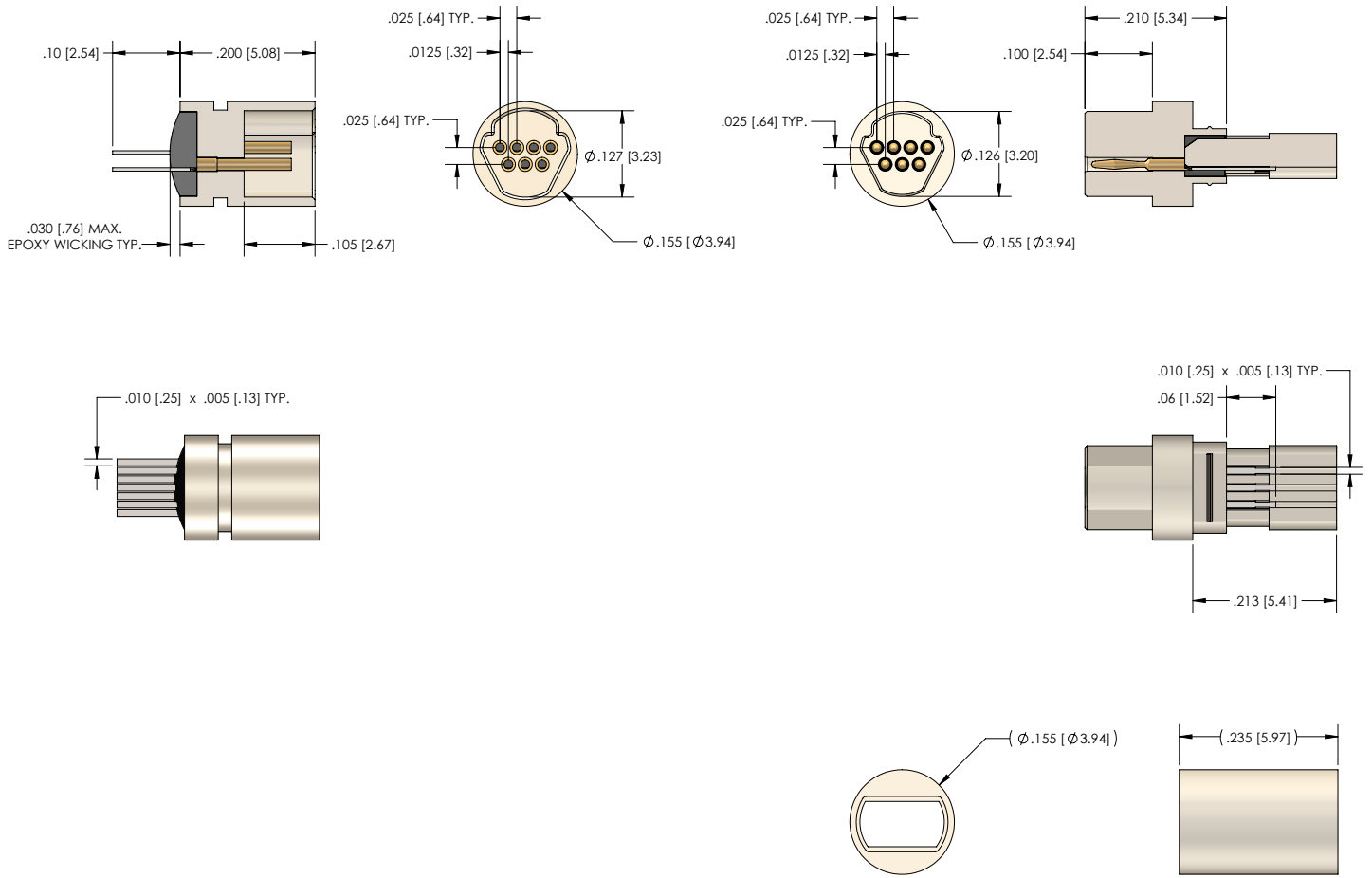

BACKSHELL SHOWN UNASSEMBLED FOR PART CLARIFICATION ONLY

CIRCULAR WIRED CONNECTOR



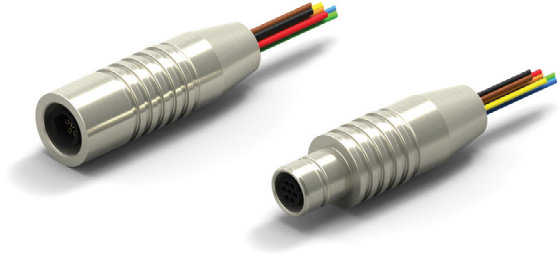

- Metal Shell Connector w/Wire Leads
- Operating Temperature -50° C to 200° C
- 7, 12 and 19 Contacts
- IP67 Option



NANO D – PID 113

HOW TO ORDER

* Indicates preferred standard ** Consult factory for other plating options

RN		B	Ø	- Ø7	P	- 3Ø	F	6	- 18	A	- SØ1	
RN	Series	Mounting Style	Connector Size	Contact Gender	Wire Gauge	Wire Type	Color Code	**Length	Modifications	Finish**	Temp Range	
RN= Round Nano	B= Break Away	Ø= Inline	Ø7	P= Male/Pin (Plug Side)	3Ø*	*F= Stranded, w/ Teflon insulation, per NEMA HP3-ET	1= White	*18.Ø	Blank= No Modifications	*SØ1= Nickel	*blank = 125C	
			12		32	Y= Stranded w/ Tefzel insulation, per SAE AS22759/33	*6 = 10 solid colors, repeating	*36.Ø	A= With Sealing O-ring (IP-67)		HT = 200°C	
			19	S= Female/Socket (Receptacle Side)	34	A= Stranded, per DSCC Ø4Ø47-3ØA (White, 3Ø AWG only)				SØ3 = Black Anodize		
												
										SØ9= Stainless		
												

ELECTRICAL PERFORMANCE DATA	Go to Page 33 See chart 123 E or Click Here for Electrical Performance Data
MECHANICAL PERFORMANCE DATA	Go to Page 33 See chart 123 M or Click Here for Mechanical Performance Data
MATERIALS DATA	Go to Page 33 See chart 113 M&F or Click Here for Materials and Finishes Data

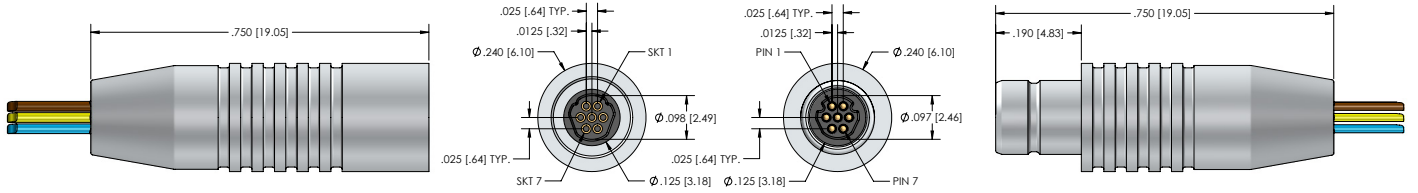

7 POSITION RECEPTACLE

7 POSITION PLUG

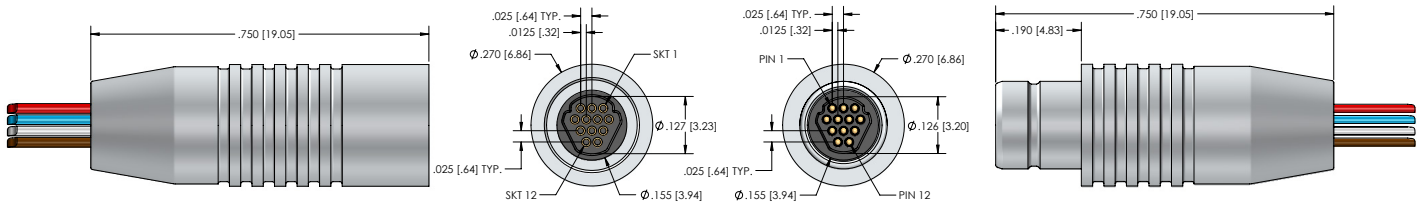

12 POSITION RECEPTACLE

12 POSITION PLUG

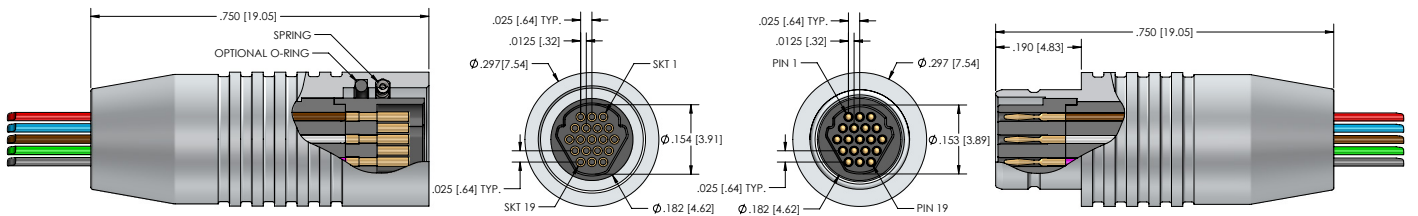

19 POSITION RECEPTACLE

19 POSITION PLUG

CIRCULAR WIRED CONNECTOR

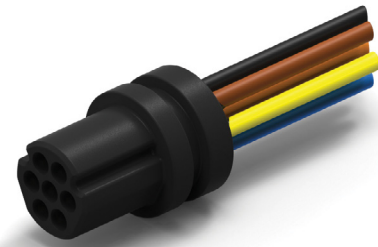

- Plastic Connector w/Wire Leads
- Operating Temperature -50° C to 200° C
- 7, 12 and 19 Contacts



NANO D - PID 122

HOW TO ORDER

* Indicates preferred standard

RN	P	O	P	- Ø7	P	- 3Ø	F	6	- 18.Ø	
	Type	Mounting Style	Material/Plating	Connector Size	Contact Gender	Wire Gauge	Wire Type	Color Code	Length	Temp Range
RN= Round Nano	P=Plastic (No Shell)	O=Inline	P=Plastic	Ø7	P=Male/Pin (Plug Side)	3Ø*	*F=Stranded, w/Teflon insulation, per NEMA HP3-ET	1=White	*18.Ø	*blank = 125C
				12		32	Y=Stranded w/Tefzel insulation, per SAE AS22759/33	*6 = 10 solid colors, repeating	*36.Ø	HT = 200°C
				19	S=Female/Socket (Receptacle Side)	34	A=Stranded, per DSCC Ø4Ø47-3ØA (White, 3Ø AWG only)			
										

ELECTRICAL PERFORMANCE DATA	Go to Page 33 See chart 123 E or Click Here for Electrical Performance Data
MECHANICAL PERFORMANCE DATA	Go to Page 33 See chart 123 M or Click Here for Mechanical Performance Data
MATERIALS DATA	Go to Page 33 See chart 122 M&F or Click Here for Materials and Finishes Data

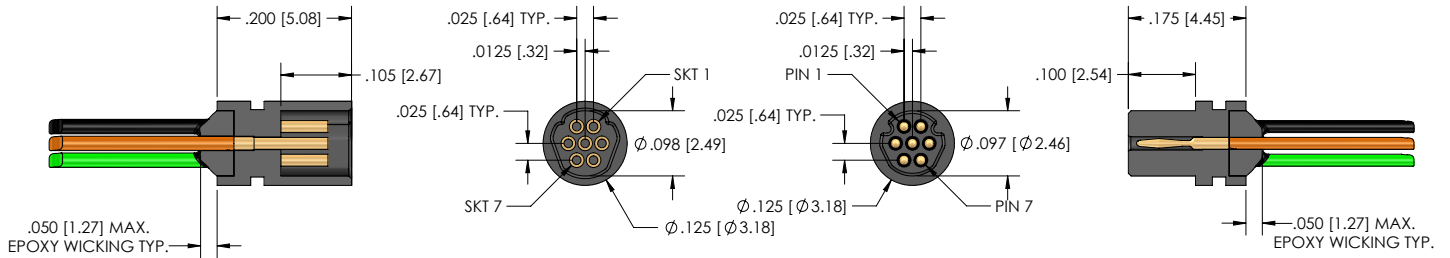

7 POSITION RECEPTACLE

7 POSITION PLUG

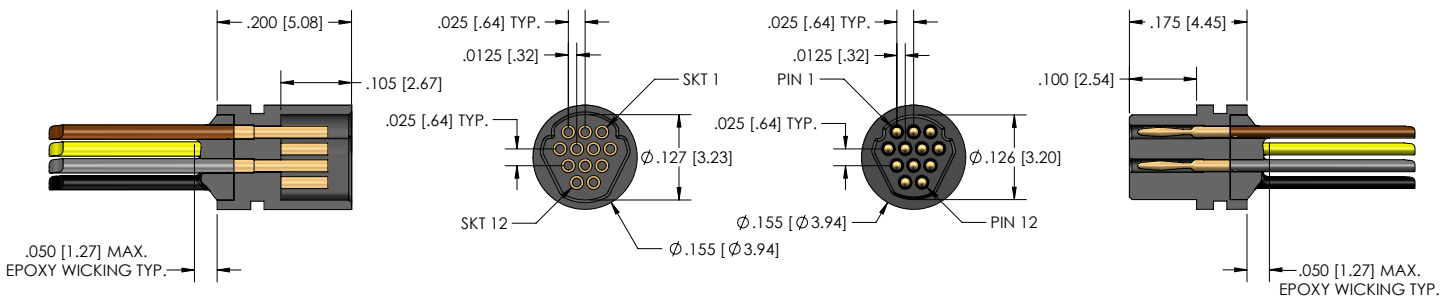

12 POSITION RECEPTACLE

12 POSITION PLUG

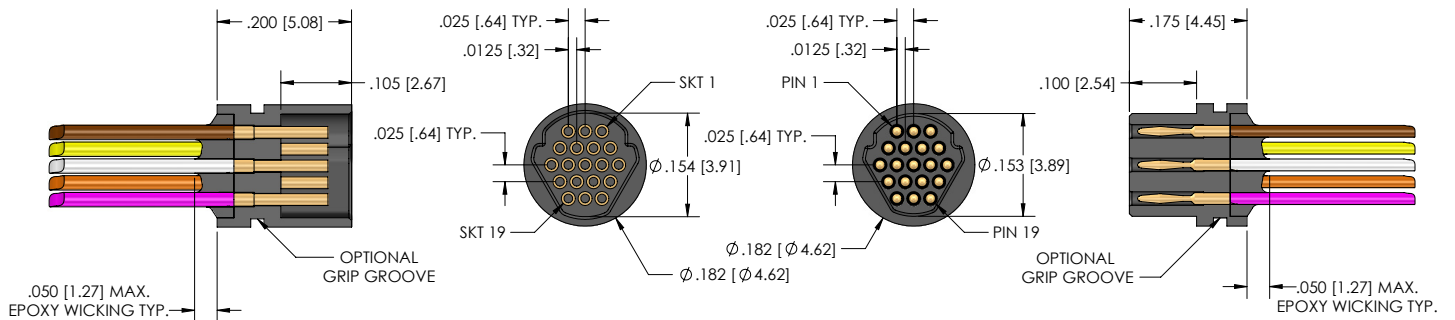

19 POSITION RECEPTACLE

19 POSITION PLUG

VISIT OUR WEBSITE FOR MORE INFORMATION ABOUT ULTI-MATE MICRO / NANO MINIATURE CONNECTORS AND CABLE ASSEMBLIES

The screenshot displays the Ulti-Mate website interface. At the top, a navigation bar includes links for Home, About Us, News And Events, Micro-D Catalog, Job Opportunities, Reps And Distributors, Glossary, and Contact Us. Below this is a search bar with a 'Keyword Search' input field, a 'Go' button, and an 'Inventory Search' link. A secondary navigation bar lists 'Products', 'Technologies', 'Applications', 'Request Information', 'Quality', and 'Blog'. The main content area features a large banner for 'Ulti-Mate Connector Inc. MICRO/NANO MINIATURE CONNECTORS & CABLE ASSEMBLIES' on the left and a detailed product page for a 'WIRED CONNECTOR' on the right. The product page includes a 'HOW TO ORDER' section with a table of options, a 'PERFORMANCE DATA' table, and technical diagrams. Below the banner, there are two sections: 'find a connector style' with a grid of product images and a 'product family' dropdown menu, and 'featured product' which highlights the same 'Ulti-Mate Connector Inc. MICRO/NANO MINIATURE CONNECTORS & CABLE ASSEMBLIES' banner with a 'Try it now!' call to action.

